



CREATOR[®] 快捷

CREATOR CORPORATION (CHINA)







**6301 Series Digital Wireless Conference
System User Manual**

V1.1

Meanings of the Icons

■ Safety Instruction

Symbols are used in the Manual and devices, referring to the possible risk to users or others as well as the damage to property, for helping you to safely and properly use the devices. The instruction and the implications are as follows. Please make sure your correct understanding of these instructions before using the Manual.

	<p>To remind user to conduct according to the attached operation and maintenance instructions. If ignore these information, death or injury could possibly happen.</p>
	<p>To remind the user that the risky uninsulated voltage in the device could caused electric shock to human.</p>
	<p>CE authentication indicates the product is in line with the EU safety regulation, and for assurance of safety use.</p>
	<p>SGS Authentication indicates the product has reached the QC standard of the global-biggest Swiss universe surveyor.</p>
	<p>his product has acquired the ISO9001 International Quality Authentication (Authentication authority: Germany Rheinland TUV)</p>
	<p>Caution: To avoid electric shock, please don't open the case, nor put the useless parts in it. Please contact with qualified service staff.</p>

■ General Information Instruction

	<p>List the situation could cause unsuccessful operation or setup, and relevant information needed to notice.</p>
---	---

Important Notice



Caution

To ensure the device in reliable use and personal safety, please abide by the following items when in installation, use and maintenance:

Notice in installation

◆ Please DO NOT use the product in following places: the places with dust, oily smoke, electrical conductive dust, corrosive gas, inflammable gas; the places with high temperature, due, rain and wind exposures; the places endangered by shock and vibration. Electric shock, fire and incorrect operation could also cause damage and deterioration to the product.

◆ When conducting screw drilling and wiring process, DO NOT let metal irons and wire lead drop into the controller and air vent, which could possibly cause fire, failure and accidental operation.

◆ After finishing the installation, it is necessary to ensure there is no foreign matter including the packing material like contact paper on the ventilation surface, otherwise, it could cause poor heat dissipation while running, as well as fire, failure and accidental operation.

◆ Avoid conducting wiring and plugging in/out cable socket with electricity, otherwise, electric shock, circuit damage could easily happen.

◆ Installation and wiring should be firm and reliable. Poor contact could cause malfunction.

◆ With regard to the application situations with strong interference, shielded cable should be used for the input and output of HF signal, to improve the anti-interference performance of the

system.

Note in Wiring

◆ Installation and wiring shouldn't be conducted until external electric power is cut off, otherwise, electric shock or device damage could happen.

◆ The product is grounded by the earth lead of the power cable. To avoid electric shock, the earth lead is necessary to be connected with the ground. Before making connection with the output end or input end of the product, please ensure it is correctly grounding.

◆ Upon finish wiring, remove the sundries. Please cover up the terminal plate for avoiding electric shock.

Note for Operation and Maintenance

◆ Please DO NOT touch the terminal when with electricity, otherwise, electric shock could happen.

◆ Don't clean up and screw the terminal tight before power is off. Such operation could cause electric shock when with electricity.

◆ Please turn off the power before connecting or disconnecting the communication signal cable, peripheral modules or control units, otherwise, device could be damaged and accidental operation could happen.

◆ Please DO NOT disassemble the device, so as to avoid internal electric components damage.

◆ It is necessary to read through the Manual and fully ensure the safety, before altering the program, trial running, starting and stopping operation.

Note for declaration of worthless.

When declaring of worthless, please note

◆ Explosion of electrolytic capacitor on the circuit board could happen when burning it.

◆ please classify and dispose it. Don't dispose it into household garbage.

◆ please deal it as industrial waste, or in

accordance with local environmental protection regulation.

Preface

This manual mainly provides operation guidance, main specifications, and common malfunction solutions for WIFI6301 Conference system mainframe, WIFI6302B Chairman Unit, WIFI6304B delegate unit, and CR-WF30A wireless AP.

This manual is for user's operation guidance only, not for maintenance. All changes in functions or specifications after the publication of this manual will be illustrated separately. Please refer to CREATOR or its distributors for the details.

This manual is protected by "Copyright Law of the People's Republic of China" and other intellectual property rights protection laws and regulations. This manual should not be copied or distributed without written consent from CREATOR.

Menu

Chapter One, General Introduction	0
1.1 About the Wired/Wireless Digital Network Integrated Conference System	0
1.2 System Features	0
1.3 System Equipment	1
1.4 System Diagram	1
Chapter Two, WI-FI Encrypted Conference System Mainframe.....	2
2.1 General Introduction	2
2.2 CR-WiFi6301 Front Panel	2
2.3 CR-WiFi6301 Function Features	4
2.4 CR-WiFi6301Front Panel Buttons Function	5
2.4.1 Mainframe Menu Structure	6
2.4.2 Button Function Illustration.....	7
2.4.3 Mainframe Menu Illustration	8
2.4.3.1 MIC MODE.....	8
2.4.3.2 ACTIVE MIC	8
2.4.3.3 VOLUME.....	9
2.4.3.4 EQUALIZER.....	10
2.4.3.5 ZONE.....	11
2.4.3.6 UNIT SCAN	13
2.4.3.7 NETWORK SETTING.....	13
2.4.3.8 TRANSLATE	15
2.4.3.9 CAMERA	16
2.4.3.10 LANGUAGE	17
2.4.3.11 MISC.....	17
2.4.3.12 DEFAULT.....	18
2.4.3.13 VERSION.....	19
2.4.4 Menu Software Illustration	19
2.4.4.1 MENU Options Illustration	19
2.4.4.1.1 “Connection” Options Illustration.....	20
2.4.4.1.2 “Conference System Mainframe” Options Illustration.....	20
2.4.4.1.3 “UNIT MANAGEMENT” Options Illustration	20
2.4.4.1.4 “WIFI MANAGEMENT” Options Illustration.....	21
2.4.4.1.5 “SOFTWARE LANGUAGE” Options Illustration	23
2.4.4.1.6 “EXIT” Options Illustration	23
2.4.4.2 Connection and Settings Reading	23
2.4.4.3 “MEETING MANAGEMENT” SETTINGS	23
2.4.4.3.1 Microphone mode.....	23
2.4.4.3.2 Speakers Quantity.....	23
2.4.4.3.3 System Language	24
2.4.4.4 “AUDIO SETTINGS” CONFIGURATION.....	24
2.4.4.4.1 DSP AUDIO EFFECTS SETTINGS AND UNIT LOUDSPEAKER SWITCH	
.....	24

2.4.4.4.2	Volume	24
2.4.4.4.3	SOUND FIELD CHOICE	25
2.4.4.5	Camera Settings	25
2.4.4.5.1	CAMERA PROTOCOLS.....	25
2.4.4.5.2	CAMERA MAPPING	25
2.4.4.5.3	START CAMERA SETTINGS.....	25
2.4.4.6	TRANSLATION SETTINGS	26
2.4.4.6.1	Automatic Channel Selection.....	26
2.4.4.6.2	Total Translation Channel Quantity.....	26
2.4.4.6.3	Translation Room Settings.....	26
2.4.4.6.4	Channel Lock.....	26
2.4.4.6.5	Channel Language.....	26
2.4.4.7	Loudspeaker Zoning Settings	26
2.4.4.7.1	Loudspeaker Zoning	27
2.4.4.7.2	Loudspeaker Zoing Settings.....	27
2.4.4.7.3	Loudspeaker Zoing Gain.....	27
2.4.5	ID BUTTON	28
2.5	ETHERNET Cable Wiring Instructions.....	28
2.6	CONTROL SYSTEM COM PIN Definition	28
2.7	AUDIO OUTPUTS 3.5mmAudio Interface Wiring Instruction	29
2.8	CR-WiFi6301 Mainframe Installation.....	29
2.9	CR-WiFi6301 Technical Specifications.....	29
Chapter Three,	Wifi Conference System Unit	30
3.1	General Introduction.....	30
3.2	CR-WiFi6302/4B Front Panel.....	30
3.3	CR-WiFi6202/4B Function Features	31
3.4	CR-WiFi6302/4B Operation	32
3.4.1	CR-WiFi6302/4B SSID and Password Settings	32
3.4.2	CR-WiFi6302/4B ID Settings.....	32
3.4.3	CR-WiFi6302/4B Audio Download Authorization Settings.....	33
3.4.4	CR-WiFi6302/4B other commonly used interfaces.....	33
3.4.5	CR-WiFi6202/4B Usage.....	34
3.5	CR-WiFi6202/4BTechnical Specifications:	34
Chapter Four,	Wireless AP	35
4.1	General Introduction.....	35
4.2	CR-WF30A Front Panel.....	35
4.3	CR-WF30A Function Features	37
4.4	CR-WF30A Settings	37
4.4.1	Basic Settings.....	38
4.4.2	Advanced Settings	39
4.4.2.1	Performance.....	26
4.4.2.2	Dynamic Pool Settings	40
4.4.3	Administration Settings.....	40
4.4.4	Take the Settings into Effect.....	41

4.5 Connection Diagram	41
4.6 Technical Specifications:	41
Chapter Five, System Settings	42
5.1 System ID Settings	42
5.1.1 Wireless AP Settings	42
5.1.2 System Connection.....	42
5.1.3 Conference System Units Settings	43
5.2 Camera Auto-tracking Settings	42
5.2.1 Settings Steps	42
5.3 Settings for newly added Unit	43
Chapter Six System Connection Diagram	44
6.1 One AP in One System Connection Diagram	45
6.2 Multiple AP in One System Connection Diagram	46
Chapter Seven Accessories	46
7.1 Charging Case	46
7.2 CR-P2 Headphone	47
7.3 CR-W6KL215B 215mm Cardioid Directional Microphone	48
7.4 CR-M4KL415 knob 415mm Microphone (Optional)	48
7.5 CR-DOCK10B Wireless Conference System Unit Charging Dock (Optional)	48
7.6 Power Adapter	48
7.7 RS-232 Communication Cable	48
Chapter Eight Appendix	48
8.1 CREATORConference System Protocols Format and Description	49
8.2 PELCO-D Camera Control Protocol Format and Illustration	49
8.3 PELCO-P Camera Control Protocol Format and Illustration	50
8.4 VISCA Camera Control Protocol Format and Illustration	51
8.5 HD Camera CR-V1013 Settings	52
8.5.1 CR-V1013 Camera Settings.....	52
8.5.2 CR-V1013 Camera VISCA Protocol Connection	52
8.5.2.1 CR-V1013 RS-232 PIN definition.....	52
8.5.2.2 CR-V1013 VISCA Protocols Connection.....	53
8.5.3 Conference System Mainframe, Matrix Switcher and the Camera's Connection	53

Chapter One, General Introduction

1.1 About the Wired/Wireless

Digital Network Integrated

Conference System

Wireless conference systems are extremely convenient for installation and use, and not limited by the meeting rooms, thus, it has become a very important direction of the conference system technology development. Oriented by the clients' requirements, CREATOR independently developed the wired/wireless digital network integrated conference system. The concise, intelligent design concept brings convenience and flexibility to everything.

CREATOR WIRELESS/WIRED DIGITAL NETWORK CONFERENCE SYSTEM includes the mainframe, units, and the wireless AP, which can satisfy different meeting requirements. Now, no matter in small meeting rooms or in big meeting halls, all kinds of meetings and seminars can be conducted very conveniently and flexibly.

1.2 System Features

◆ **No need for wiring or drilling;**

◆ **Saving Cost**

WiFi Conference system does not need redecoration, which is easy to use.

◆ **Not limited by the meeting rooms; swift settings procedures; no damage caused to the meeting room.**

The wifi conference system is install-and-play. No matter in what situation, the users can immediately use the system after putting the system on the table. And they can be also

immediately removed after the meeting.

◆ **No blocking, no interference**

Standard 802.11n WIFI technology; strong piercing capability; not interfered by the walking people;

◆ **Internal Antenna**

Internal antenna design, which keep a concise outlook for the unit. What's more, this design can successfully protect the antenna to avoid the interrupted communication due to damaged antenna.

◆ **All-dimensional Status Indication**

The conference system unit can display all status information no matter the unit is online or offline.

◆ **Reliable Encryption System**

Support WPA/WPA2 wireless security technology; Support SSID of 32bit length, SSID invisibility, and 32 bit long key to ensure the privacy of the meeting.

◆ Mixed system of WIFI wireless conference system and wired DIG system. It can completely support CREATOR DIG Full-digital Conference System; supporting voting, signing-in, digital name plate, wired simultaneous interpretation, as well as the wifi conference system.

◆ **DIG System supports looping connection**

The DIG full-digital conference system supports looping connection, which brings more stability.

◆ **Two-way DSP Processing**

Two-way feedback and noise suppression. The use can choose DSP processing for the conference system unit or the 4 ways line output.

◆ **Perfect Sound Quality**

Wireless non-compression audio transmission; bandwidth: 20Hz ~ 20KHz; perfect sound quality.

◆ **Wireless Auto-tracking**

Working with the CR-MVC4200HD and CR-

IRC20 to realize wireless unit IR localization camera auto-tracking function.

◆ 4 ways loudspeaker zoning

Maximally support 4 ways loudspeaker zoning; 4 groups of zoned loudspeaker gain can be adjusted separately.

◆ Satisfying big scale meeting requirements

The Wifi conference system maximally supports 240 units, and the DIG Conference System maximally supports 4000 units. When mixed and used together, there can be maximally 4000 units working under the same system.

◆ Support PC Management Software

The wifi and DIG conference systems support meeting software management.

1.3 System Equipment

CREATOR wireless/Wired integrated digital network conference system mainly include the following equipment:

- ◆ CR-WiFi6301 Wireless digital network conference system mainframe
- ◆ CR-WiFi6302B Wireless digital network conference system chairman unit
- ◆ CR-WiFi6304B Wireless digital network conference system delegate unit
- ◆ CR-WF30A wireless access point
- ◆ DIG Conference system unit and connection box

1.4 System Diagram

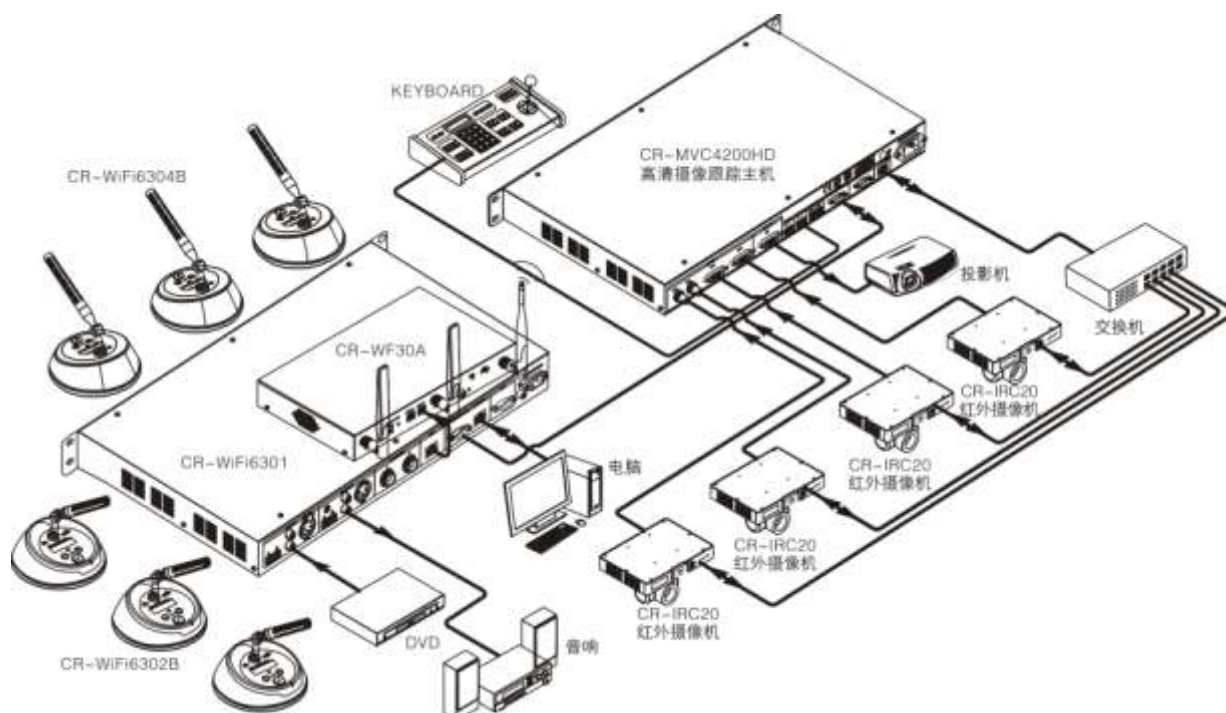

Chapter Two, WI-FI Encrypted Conference System Mainframe

2.1 General Introduction

The CR-WiFi6301 encrypted conference system mainframe can control all the conference functions altogether through the front panel navigation buttons and the LCD display. There are multiple meeting modes for selection: speaker quantity selection, speaking mode selection. It supports the mixed usage of the WiFi conference system and the DIG full-digital conference system. Two-way DSP technology has been applied for the audio processing. The built-in equalization module can ensure the high-fidelity audio effect. It has also been integrated with camera auto-tracking function to realize

whole course camera auto-tracking function for the modern high technology meeting.

2.2 CR-WiFi6301 Front Panel

Front panel:

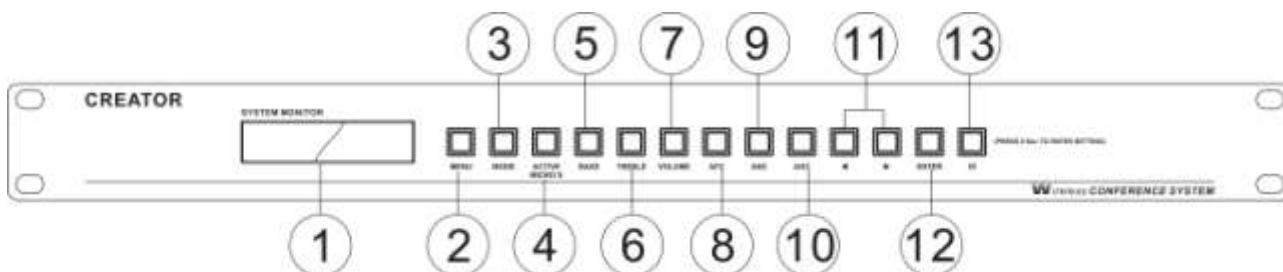

Back Panel:

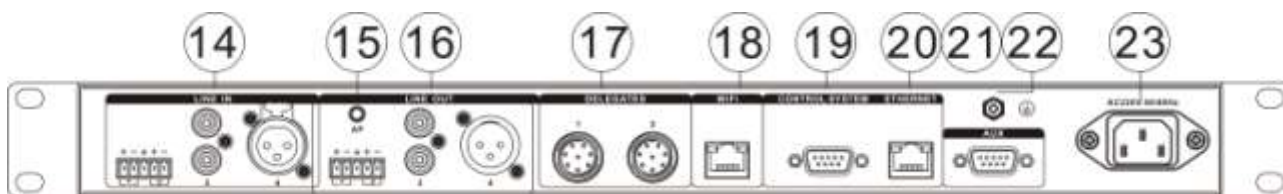

① LCD Display

Display the menu settings page and parameters for MIC MODE, MIC ACTIVE'S, BASS, TREBLE, VOLUME, CAMERA.

② MENU

Menu button, for menu options

③ MODE

Microphone mode settings button; there are following four modes:

◆ **FIFO**: when the system reaches its maximum allowed speakers quantity, the first coming in speaker will be turned off by the latest

coming in speaker.

◆ **NORMAL**: When the system reaches its maximum allowed speakers quantity, the newly applying speaker will automatically enter the waiting queue.

◆ **FREE**: maximally allow 6 speakers on at the same time (not including the chairman unit); new applying speaker will enter the waiting queue automatically.

◆ **APPLY**: the applying delegate units have to be approved by the chairman unit; the waiting speakers' quantity is the same as the maximally allowed speakers quantity; signing-in and voting functions will close the delegate speakers or clear the waiting queue.

④ **ACTIVE MICRO'S**

Active speakers' quantity limitation: when the system is running on DIG mode, the simultaneous active speakers' quantity can be 1/2/4/6 pieces; when the system is running on WIFI mode, the simultaneous active speakers quantity can be 1/2/4 pieces.

⑤ **BASS**

Low volume gain button for bass settings of the microphone output audio

⑥ **TREBLE**

High volume gain button for treble settings of the microphone output audio

⑦ **VOLUME**

Volume adjustment for line audio output; press this button to enter line audio output volume adjustment menu.

⑧ **AFC**

Anti Feedback Control button; when the mainframe menu chooses DSP channel 1, and the indicator displays as DSP channel 1, this button controls the channel 1 DSP status; the same operation is for controlling channel 2.

When the indicator is ON, it means the AFC function is ON; if there is no response after pressing the button, it means there is no DSP function.

⑨ **ANC**

Anti Noise Control Button, when the mainframe menu chooses DSP channel 1, and the indicator displays as DSP channel 1, this button controls the channel 1 DSP status; the same operation is for controlling channel 2. When the indicator is ON, it means the ANC function is ON; if there is no response after pressing the button, it means there is no DSP function.

⑩ **AGC**

Automatic Gain Control Button, when the mainframe menu chooses DSP channel 1, and the indicator displays as DSP channel 1, this button controls the channel 1 DSP status; the same operation is for controlling channel 2. When the indicator is ON, it means the AGC function is ON; if there is no response after pressing the button, it means there is no DSP function.

11 ◀ and ▶

Left and Right navigation button, for moving the cursor left and right to make a selection.

12 **ENTER**

Confirm to execute operation button, used to confirm the operations or save the settings.

13 **ID**

ID setting button, used for setting the system into or out of ID Settings Status: long-press to enter ID settings; Long-press again to exit ID Settings.

14 **LINE IN**

Line In 2 input can connect to remote video conference and telephone conference terminal. Through the operations on the menu: “Audio Settings” – “Video Conference Volume” – “Line In”, the Line In 2 input audio volume can be adjusted. Select “Loudspeaker Zoning Settings” → “Video Conference Output”, the audio from Line IN 2 will not be sent to the corresponding Line out. When there is background music to LINE IN 1, 3, 4, the mixed sound volume can be adjusted through the menu software: “Audio Settings” → “Volume” → “LINE IN”. The mixed sound will keep output from the line out.

LINE IN1 and LINE IN 2 support both balanced and unbalanced input;

LINE IN 3: RCA interface, only supporting unbalanced input;

LINE IN 4: only support balanced input;

15 AP

Audio download and authentication interface, used for connection to CR-WF30A wireless AP's “AUDIO” jacket.

16 LINE OUT

Audio output interface, for connection to PA system to amplify the system audio, or to the audio recording system.

When the loudspeaker zoning function is turned off through the menu software, the output from Line Out 1, 2, 3, 4 are the same.

When the loudspeaker zoning function is turned on, the Line Out 1 is correspondent to the OUT 1 on the menu software; this correspondence is the same between Line Out 2 and Out 2, Line Out 3 and Out 3, and Line Out 4 and Out 4.

The loudspeaker zones' volume can be adjusted through: “Audio Settings” – “Line Out”. When the loudspeaker zoning function is turned on, the gain of every zone can be adjusted separately.

17 DELEGATES—Conference System Unit Connection Interface

Provides 2 ways DIG conference system unit connection interfaces, which can connect to the speaking unit, the translator console, or the unit connection box. Loop connection is also supported.

18 WiFi

The LAN (PoE) port for connection to CR-WF30A.

19 CONTROL SYSTEM

This port can connect to CREATOR intelligent central controller, the camera auto-tracking controller, or connection to the cameras directly to realize camera auto-tracking function. When it is directly connected to cameras that are using RS485 protocol, there must be a RS232 to RS485 converter in-between.

20 ETHERNET

1 way Ethernet connection interface for connection to a computer to realize conference system software management function.

21 AUX—RS-232 Serial Port

When the conference system mainframe directly controls the cameras, this port can be connected to CREATOR matrix switcher to realize multiple cameras video input.

22 Grounding Pole

For grounding wiring

23 System Power input

Mainframe power supply input, supports AC110V/220V

2.3 CR-WiFi6301 Function

Features

◆Support WPA/WPA2 wireless security technology to ensure the privacy of the meetings and avoid wiretapping and malicious interference. Maximally support 32 bit SSID, 64-bit Key, and

SSID invisibility.

- ◆ Support WIFI Conference system and DIG Conference system at the same time;
- ◆ DIG Full Digital Conference System supports looping connection;
- ◆ The provide 1 RJ45 interface can be used to directly connect to one wireless AP or to a network switch, then connect to multiple wireless APs to suite the needs of large scale meeting.
- ◆ Compatible with IEC 60914, GBT 15381-94;
- ◆ Cat5e shielding cable; 100M network full digital audio and control signals transmission to ensure the sound quality over long distance transmission;
- ◆ Built-in with high performance CPU; integrated with translation, discussion, voting, signing-in, and digital name plate functions together; Maximally support 4000 conference system units;
- ◆ Non-compression audio transmission; 48K sample rate; 20Hz ~ 20KHz bandwidth; perfect sound quality;
- ◆ The system can support maximally 8 active microphones at the same time, and for wireless conference system, the max active microphone quantity can be 6. Support 31+1 wired simultaneous interpretation.
- ◆ 23 bit high speed DSP float point processing; support 2 ways audio acoustic feedback suppression and noise cancellation; provide clear and high sensibility perfect audio quality;
- ◆ Support PC management software, TCP/IP control, providing reliable and safe management and control;
- ◆ Support PELCO-D, VISCA, SAMSUNG, and CREATOR multiple camera control protocols; working with CREATOR matrix switcher or controller it can realize camera auto-tracking function; together with HD camera auto-tracking mainframe and HD IR auto-tracking camera, it can realize WIFI conference system unit auto-tracking function;
- ◆ the PC management software can realize centralized manage and smart malfunction

diagnosis of the units: it can analyze the model, quantity, allocation, and malfunctions, etc.

- ◆ Two-CCU hot backup function supported: even though one of the two mainframes malfunctions, the meetings can keep going on, and the discussion, voting functions won't be disturbed;
- ◆ Built with RCA, Phoenix, and XLR three types interfaces for audio input; support balanced and unbalanced connection for 4 ways mixed audio input or 3 ways mix audio and 1 way remote video conference input;
- ◆ Built with RCA, Phoenix, and XLR three types interfaces for audio output; support balanced and unbalanced connection; Support conference system units zoning, and adjusting their sensibility; Support 4 ways loudspeakers zoning output, which can effectively improve the microphones' gain without hawling effect; any one of the output can be connected to remote video conference system;
- ◆ the LINE IN, remote video conference input, 4 ways audio output, conference system units' volume can be adjusted independently; the adjustable range is: -40dB ~ 0dB;
- ◆ multiple types of microphone audio field are provided; the users can also define their own audio field effect;
- ◆ the system can run without the PC management software
- ◆ the system codes can be maintained through the network port;

2.4 CR-WiFi6301 Front Panel

Buttons Function

For convenient management, operations, and

system settings CREATOR designed the navigation panel and LCD display.

Basic Operation

Function Buttons → Navigation Buttons → ENTER confirm button → Navigation buttons → ENTER to confirm

When the operations are complete, after about 10 seconds, if there is no any other operations, the system will exit settings interface automatically.

LCD Display

LCD will stay on after the mainframe is powered up. It will display the current system status and operations with white character color and a blue background light.

Button Light

The button light will be flashing red color: when the red light flash one time, it means this button's function or parameter is successfully selected, and the LCD will also display the relevant information.

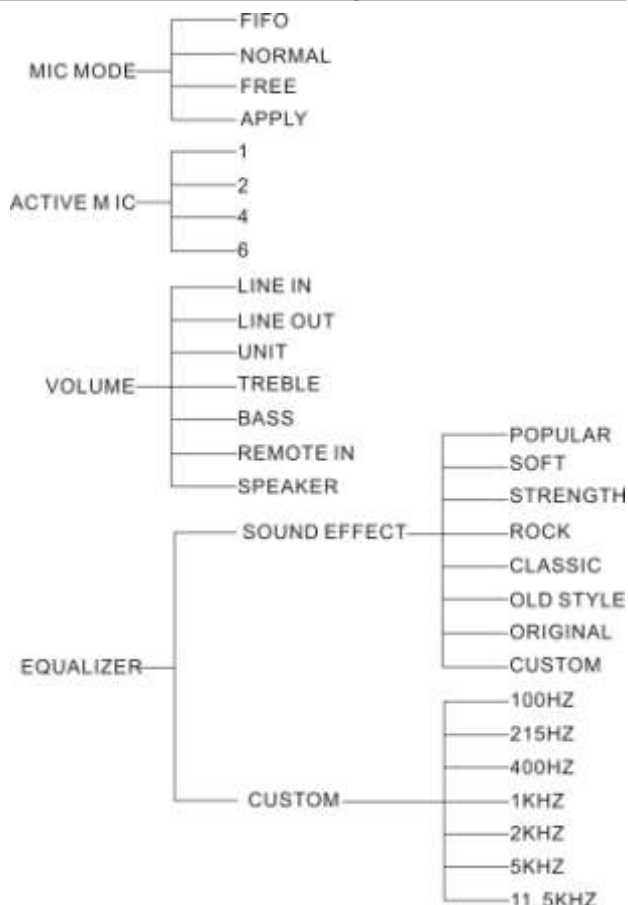

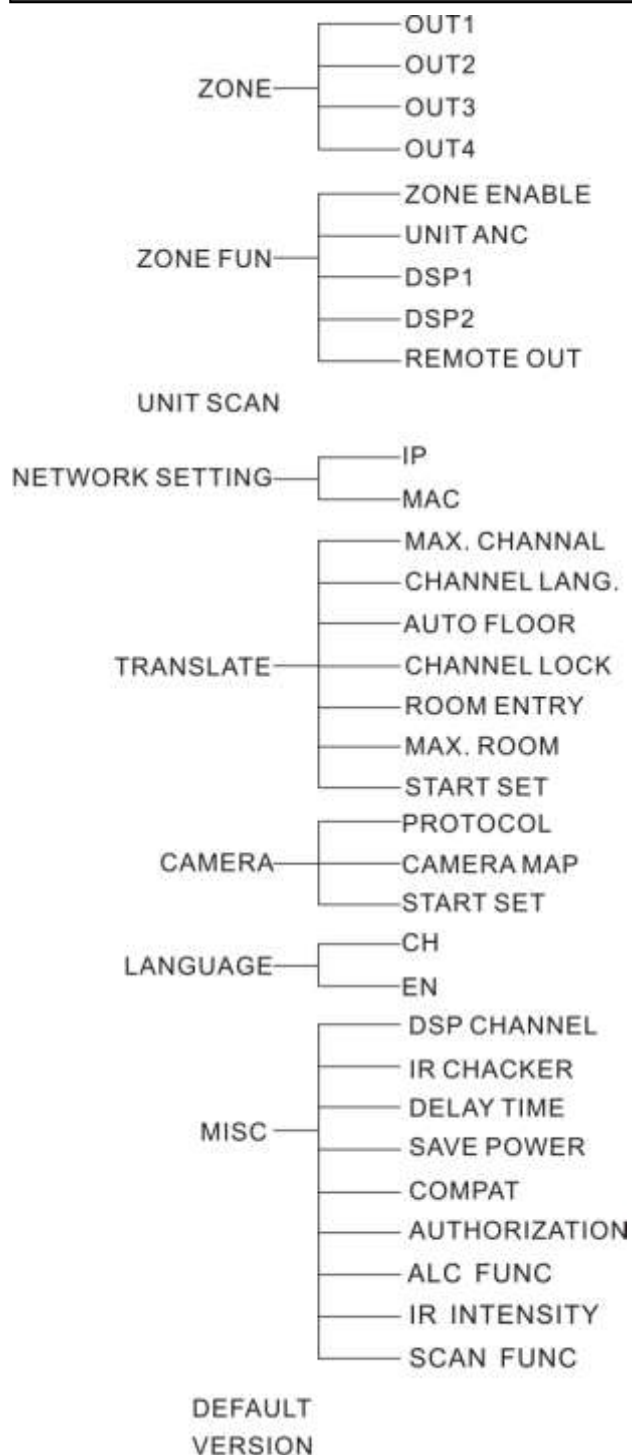

2.4.2 Button Function Illustration

The operations under MENU button, you can perform settings for MIC MODE, MIC ACTIVE'S, BASS, TREBLE, VOLUME, and CAMERA. The detailed steps are as following:

1、Press down the “MENU” button, the LCD display will show the first option “MIC MODE”;

2、Press “◀” or “▶” to browse all the options, and the same time, the LCD display will show the current operation status. Choose the options you want to change the settings of, and then press “ENTER” to confirm.

3、After entering the option parameters settings page, press “◀” or “▶” to select the item you want to change the settings of.

4、Press “ENTER” to confirm the set parameter.



If you have not exited the settings page, when you press the “MENU” button, the LCD will show the options of the last operation, not the first option.

For example: The operations to set the Microphone mode to NORMAL (set quantity mode) are as following:

1、Press “MENU” button on the navigation panel to enter the speakers’ mode selection page, at the same time, its button light will be ON for one time, and the LCD will display relevant information.

2、Use the navigation buttons “◀” and “▶” to move left and right. Every press of the button, the button’s light will be turn on once. Select “MIC MODE” and then press “ENTER” to enter the microphone mode settings page. The “ENTER” button light will be turned on, and the LCD display will show the options for microphone mode settings.

3、Press the navigation buttons “◀” and “▶” to select the “NORMAL” mode, and its button light will be turned on, and the LCD will display the relevant message.

4、Finally, Press “ENTER” to confirm the

operations.

You can also directly press the “MODE” button on the navigation panel to enter the menu settings. And then only the step 3 and 4 of above will be necessary to achieve the settings, which is faster and more convenient.

2.4.3 Mainframe Menu Illustration

The mainframe menu mainly have 13 options:

MIC MODE

To set the microphone mode

ACTIVE MIC

To set the maximum active microphone quantity

VOLUME

To set the volume related parameters

EQUALIZER

Microphone equalizer settings, to set the microphone sound field effects.

ZONE

To set the zones of the microphones

UNIT SCAN

To scan the conference system units

NETWORK SETTING

To set the network IP address, and the MAC address

TRANSLATE

To set the translator console related parameters

CAMERA

To set the camera related parameters

LANGUAGE

To set the language of the conference system units

MISC

Other mischievous settings

DEFAULT

Reset to factory settings

VERSION

Mainframe version number and manufacturer information

After the mainframe is powered up, the default page will show as following:



UNIT: it shows here the total conference system units' quantity. Units that have the same ID will be recognized as one device. The devices that don't have a ID (e.g. the channel selector) will not be counted in.

MIC: it shows here the microphone mode and maximum active speakers quantity. In the above image, it means the system is under “FIFO” mode, and the maximum active microphone quantity is 4.

2.4.3.1 MIC MODE

The following image shows the first level menu, “MIC MODE” option, after pressing the “MENU” button

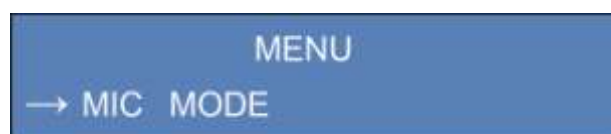

Press “ENTER” button to enter, and you can set the “FIFO”, “NORMA”, “FREE”, and “APPLY” for the microphone mode.

2.4.3.2 ACTIVE MIC

The following image shows the second option “ACTIVE MIC” of the first level menu.

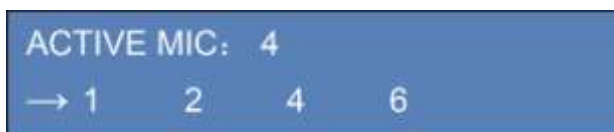

Press "ENTER" button to enter, you can then set the maximum active microphone quantity to be 1/2/4/6. Please note that while the mainframe's compatibility mode is set to be "WIFI", the maximum active microphone quantity can only be 1/2/4, and when it's set to be "DIG", the maximum active microphone quantity can only be 1/2/4/6.

2.4.3.3 VOLUME



Here you can set all volume related parameters.

1) VOLUME → LINE IN

Here you can set the LINE IN volume, shown as the following image:



Under the "LINE IN" menu, press the "ENTER" button to enter "LINE IN" volume settings. Then you can press the navigation button to set the volume level. The volume range can be; mute, -40dB ~ 0dB.



2) VOLUME → LINE OUT

Under the "LINE IN" menu, press the navigation button to enter "LINE OUT" to set all line out

volume. The volume range can be; mute, -40dB ~ 0dB.

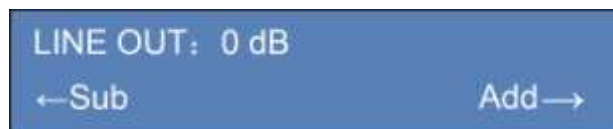

3) VOLUME → UNIT

To set the conference system units' earphone or the original loudspeaker volume. The volume range can be: mute, -40dB ~ 0dB.



4) VOLUME → TREBLE

Microphone treble adjustment: the range is -12dB ~ 12dB.



5) VOLUME → BASS

Microphone bass adjustment: the range is -12dB ~ 12dB.

BASS: -01dB

←Sub

Add→

6) VOLUME → REMOTE IN

Remote video conference system interface volume adjustment. The volume range can be: mute, -40dB ~ 0dB.

VOLUME

→ REMOTE IN

REMOTE IN: 0 dB

←Sub

Add→

7) VOLUME → SPEAKER

Conference system units' loudspeakers adjustment, translator consoles' loudspeakers not included.

VOLUME

→ SPEAKER

SPEAKER: ON

←ON

OFF→

2.4.3.4 EQUALIZER

To set the equalizer for the microphones.

MENU

→ EQUALIZER

1) EQUALIZER-> SOUND EFFECT

EQUALIZER

→ SOUND EFFECT

SOUND EFFECT: 8

→ 1. POPULAR

"POPULAR", "SOFT", "STRENGTH", "ROCK", "CLASSIC", "OLD STYLE", "ORIGINAL", "CUSTOM" are for the microphones' sound effect. When the "ORIGINAL" is selected, it means there is no equalizer, which will only take effect when selecting the following options: SOUND EFFECT->CUSTOM, EQUALIZER->CUSTOM

2) EQUALIZER->CUSTOM:

EQUALIZER

→ CUSTOM

You can set 7 equalizer bands parameters.

3) EQUALIZER->CUSTOM->100Hz settings:

CUSTOM

→ 100HZ

100HZ : 00dB

←Sub

Add→

4) EQUALIZER->CUSTOM->215Hz settings:

CUSTOM

→ 215HZ

215HZ : 00dB

←Sub

Add→

5) EQUALIZER->CUSTOM->400Hz settings:

CUSTOM

→ 400HZ

400HZ : 00dB

←Sub

Add→

11.5KHZ : 00dB

←Sub

Add→

6) EQUALIZER->CUSTOM->1KHz settings:

CUSTOM

→1KHZ

1KHZ : 00dB

←Sub

Add→

7) EQUALIZER->CUSTOM->2.2KHz settings:

CUSTOM

→2.2KHZ

2.2KHZ : 00dB

←Sub

Add→

8) EQUALIZER->CUSTOM->5KHz settings:

CUSTOM

→5KHZ

5KHZ : 00dB

←Sub

Add→

9) EQUALIZER->CUSTOM->11.5KHz settings:

CUSTOM

→11.5KHZ

2.4.3.5 ZONE

to set the speaker zones:

1) ZONE->OUT1 as shown in the following image:

ZONE

→OUT1

to set the loudspeakers' zone one parameters.

2) ZONE->OUT1->ID RANGE

OUT1

→ID RANGE

to set the ID range for the loudspeakers' zone 1. as shown in the following image:

ID RANGE: 4000

←Sub

Add→

3) ZONE->OUT1->ZONG1 GAIN

To set the gain value for zone 1 loudspeakers to the mainframe OUT1. The range can be: mute, -40dB ~ 0dB.

OUT1

→ZONE1 GAIN

ZONE1 GAIN: 0 dB

←Sub

Add→

4) ZONE->OUT1->ZONG2 GAIN

To set the gain value for zone 2 loudspeakers to the mainframe OUT1. The range can be: mute, -40dB ~ 0dB.

OUT1
→ ZONE2 GAIN

5) ZONE->OUT1->ZONE3 GAIN

To set the gain value for zone 3 loudspeakers to the mainframe OUT1. The range can be: mute, -40dB ~ 0dB.

OUT1
→ ZONE3 GAIN

ZONE3 GAIN: 0 dB
← Sub Add →

6) ZONE->OUT1->ZONE4 GAIN

To set the gain value for zone 4 loudspeakers to the mainframe OUT1. The range can be: mute, -40dB ~ 0dB.

OUT1
→ ZONE4 GAIN

7) ZONE->OUT2

ZONE
→ OUT2

8) ZONE->ZONE FUN

Loudspeakers zoning DSP processing, signal ON/OFF.

ZONE
→ ZONE FUN

9) ZONE->ZONE FUN->ZONE ENABLE

Zoning function switch: when set to be "ON",

zoning function will be turned on, and the settings of zoning for OUT1, OUT2, OUT3, and OUT4 take effect. When it's set to be "OFF", the zoning function will be turned off, and the zoning settings have no effect. The output OUT1, OUT2, OUT3, and OUT4 of the mainframe are all the same.

ZONE FUN:
→ ZONE ENABLE

ZONE ENABLE: ON
← ON OFF →

10) ZONE->ZONE FUN->DSP 1

To set the signals processed by DSP1:

- 1: processing OUT1;
- 2: processing OUT2;
- 3: processing OUT3;
- 4: processing OUT4;

If the "UNIT ANC" is selected, then only "UNIT" can be processed, and only 1 channel can be selected for processing.

ZONE FUN:
→ DSP1

DSP1 : 2
← Sub Add →

11) ZONE->ZONE FUN->DSP 2

To set the signals processed by DSP2:

- 1: processing OUT1;
- 2: processing OUT2;
- 3: processing OUT3;
- 4: processing OUT4;

If the "UNIT ANC" is selected, then only "UNIT" can be processed, and only 1 channel can be selected for processing.

ZONE FUN:
→ DSP2

MENU
→ UNIT SCAN

12) ZONE->ZONE FUN->UNIT ANC

UNIT ANC, when set to be "ON", DSP1 will process the down-issuing original sound.

ZONE FUN:
→ UNIT ANC

UNIT SCAN...
UNIT TOTAL: 0000

UNIT SCAN
UNIT TOTAL: 0000

UNIT ANC: ON
← ON OFF →

2.4.3.7 NETWORK SETTING

To set mainframe IP address and MAC address.

MENU
→ NETWORK SETTING

13) ZONE->REMOTE OUT

Remote video conference system output interface.

For example:

If it's set to be 1, OUT1 will be used as the remote video conference system connection interface. There can be multiple choices.

When a specific output interface is selected, the remote conference system input sound will not be feedbacked to output port.

ZONE
→ REMOTE OUT

NETWORK
→ IP MAC

CHANNEL: 1*2
1 2 → 3 4

1) NETWORK SETTING

->IP

NOW SETTING: 01
← Sub Add →

2) NETWORK SETTING

->IP->OPTION1

IP ADDR
→ OPTION1

OPTION1 : 192
← Sub Add →

2.4.3.6 UNIT SCAN

To scan the conference system units. It is generally used for system diagnosis to analyze whether the system lose codes.

3) NETWORK SETTING

->IP->OPTION2

IP ADDR
→ OPTION2

OPTION2 : 168
←Sub Add→

MAC
→ OPTION1

OPTION1 : 030
←Sub Add→

4) NETWORK SETTING**->IP->OPTION3**

IP ADDR
→ OPTION3

OPTION3 : 010
←Sub Add→

9) NETWORK SETTING**->MAC->OPTION2**

MAC
→ OPTION2

OPTION2 : 048
←Sub Add→

5) NETWORK SETTING**->IP->OPTION4**

IP ADDR
→ OPTION4

OPTION4 : 100
←Sub Add→

10) NETWORK SETTING**->MAC->OPTION3**

MAC
→ OPTION3

OPTION3 : 108
←Sub Add→

6) NETWORK SETTING**->IP->ENTER**

IP ADDR
→ ENTER

11) NETWORK SETTING**->MAC->OPTION4**

MAC
→ OPTION4

OPTION4 : 162
←Sub Add→

7) NETWORK SETTING**->MAC****8) NETWORK SETTING****->MAC->OPTION1****12) NETWORK SETTING****->MAC->OPTION5**

MAC
→ OPTION5

OPTION5 : 069
←Sub Add→

13) NETWORK SETTING ->MAC->OPTION6

MAC
→ OPTION6

OPTION6 : 094
←Sub Add→

14) NETWORK SETTING ->MAC->ENTER

MAC
→ ENTER

2.4.3.8 TRANSLATE to set the translator consoles' parameters

MENU
→ TRANSLATE

1) TRANSLATE->MAX. CHANNEL

To set the maximum channel numbers for the simultaneous interpretation system, the value range is: 1~32.

TRANSLATE
→ MAX. CHANNEL

MAX. CHANNEL: 32
←Sub Add→

2) TRANSLATE->CHANNEL LANG.

To set the channel language, matching the translator consoles.

TRANSLATE
→ CHANNEL LANG.

CHANNEL NUM: 01
→ English

3) TRANSLATE->AUTO FLOOR

To set the auto floor channel of the translator console: when it is ON: if there is no translation, this channel will output the original voice; if there is translation, this channel will be translated language output;

When it is OFF: there will not be original voice, if there is no translation, there is no audio output for this channel

TRANSLATE
→ AUTO FLOOR

AUTO FLOOR: ON
←OFF ON→

4) TRANSLATE->CHANNEL LOCK

When the "CHANNEL LOCK" is selected, the channel number selection function of all translator consoles' "SELECT OUT" knobs will be forbidden to avoid wrong operations.

TRANSLATE
→ CHANNEL LOCK

CHANNEL LOCK: ON
←OFF ON→

Current Room:01

5) ROOM ENTRY

TRANSLATE
→ ROOM ENTRY

6) MAX. ROOM

To set the translation room number. When there are more than one translator console put in the same translation room, as long as there is one translator console's microphone is turned on, the speakers of all other translator consoles will be turned off.

ROOM
→ MAX. ROOM

MAX.ROOM:03
←Sub Add→

7) START SET

ROOM
→ START SET

ROOM SET: OFF
←OFF ON→

NOW SETTING: 01
←Sub Add→

When the "START SET" value is "ON", all the translator consoles will display their own current translation room number, as shown in the following image:

Turn the "SELECT OUT" knob of the translator console and its display will show the translation room number one by one. When the right translation room number is selected, set the "START SET" value to be "OFF", then the translation room number settings are done.

2.4.3.9 CAMERA

To set the camera's parameters

MENU
→ CAMERA

1) CAMERA->PROTOCOL

Here you can set which protocol the camera is going to use. There are four options: SAMSUNG, VISCA, PELCO_D, and CREATOR. The CREATOR protocol is used to connect to CREATOR controller or CR-MVC4200 camera auto-tracking mainframe, or the CR-MVC6300 high definition auto-tracking mainframe, under which circumstances the camera mapping is invalid.

CAMERA
→ PROTOCOL

PROTOCOL: SAMSUNG
→PELCO_D

2) CAMERA-> CAMERA MAP

CAMERA
→ CAMERA MAP

3) CAMERA-> CAMERA MAP->CAMERA SEL

ECT

To select the camera's number

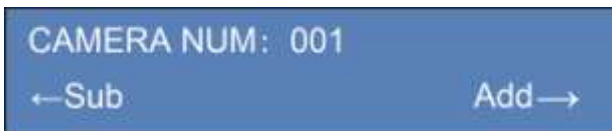

4) CAMERA->CAMERA MAP->CAMERA ADDR

To set the camera's address

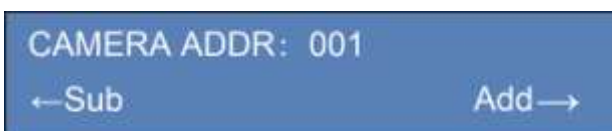

5) CAMERA->CAMERA MAP->MATRIX CHANNEL

To set the camera's mapping with CREATOR matrix's channel number

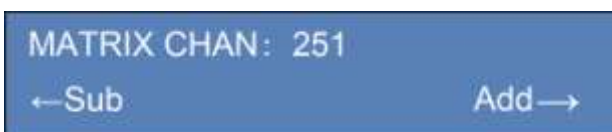

6) CAMERA-> START SET



After the camera mapping is set, we'll then set the camera's presets. The camera number is the mapping relations which we have done settings in t

he above steps. The camera number is adjustable: when we change to other cameras, the matrix switcher will automatically switch at the same time.

First select the camera which want to set the preset for. Then we adjust the relevant conference system unit's preset value. And finally we turn on the off the conference system unit microphone, the settings will be done. Use the same procedures to finish the preset settings for all the conference system units. Exiting the settings will use the current position as the panorama view position.

In order to avoid wrong operations, the system requires that there should be at least one preset is done for at least 1 ID for the panorama settings to be valid.

2.4.3.10 LANGUAGE

to set the conference system units' language

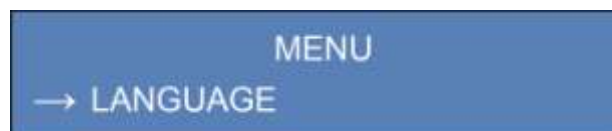

2.4.3.11 MISC



1)MISC->DSP CHANNEL

To set which channel the settings operations of the "ANC", "AFC", and "AGC" buttons on the mainframe's front panel will take effect on.

When the DSP CHANNEL 1 is selected, it means the DSP1 will be under settings status. The lights

AUTHORISING...

7) ALC FUNC

To set the ALC mode for the wifi conference system units. When the value is “ON”, the ALC function will be turned off, and when the value is “OFF” the ALC function will be turned off.

MISC
→ ALC FUNC

ALC FUNC: ON
← OFF ON →

8) IR INTENSITY

To set the brightness of the WIFI conference system units. There are 16 levels adjustment.

MISC
→ IR INTENSITY

IR INTENSITY: 15
← Sub Add →

9) SCAN FUNC

To check the conference system units ID confliction online.

MISC
→ SCAN FUNC

SCAN FUNC: ON
← OFF ON →

2.4.3.12 DEFAULT

Back to factory default settings.

MENU
→ DEFAULT

ENTER → DEFAULT
MENU → EXIT

2.4.3.13 VERSION

To check the version number and manufacturer information.

MENU
→ VERSION

www.creator.com
VERSION: 1.0

2.4.4 Menu Software Illustration

The full digital conference system can be managed easily with the “Digital Conference Menu” software.



2.4.4.1 MENU Options Illustration

MENU options include “Connection”, “Mainframe”, “Units Management”, “WIFI management”, “Language”, and “Exit” etc.

2.4.4.1.1 “Connection” Options

Illustration

The “Connection” item includes “Connection Settings” and “Automatic IP address checking”. The “Connection Settings” mainly configures the mainframe’s IP address and port number.

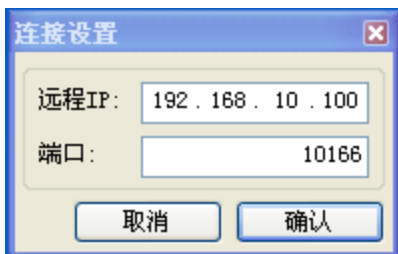

The “Automatic IP address checking” can automatically recognize the mainframe’s IP address.

2.4.4.1.2 “Conference System Mainframe” Options Illustration

“Conference System Mainframe” option includes: “Network Settings”, “MAC Address Settings”, “Temperature Control Settings”, “Restore Factory Settings”, etc.

The “Network Settings” can change the mainframe’s IP address, Mask, and Gate, etc.



The “MAC Address” can change the mainframe’s MAC address. When there are more than one piece mainframes are in the same LAN, we have to set the MAC addresses.

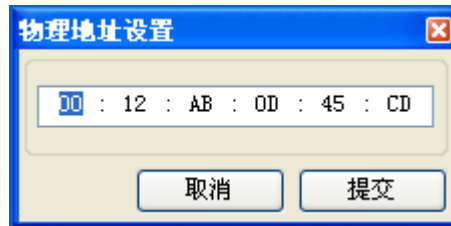

The “Temperature Control Settings” can change the mainframe’s threshold temperature value. When the current temperature reaches this value, the cooling fan will be turned on automatically.

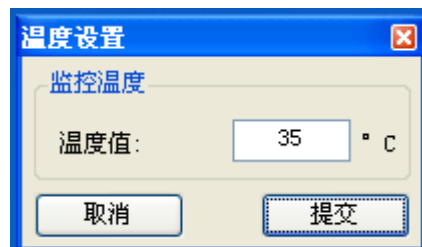

The “Restore Factory Settings” can restore all settings to default factory values.

2.4.4.1.3 “Unit Management” Options Illustration

“Unit Management” includes “Unit Scan” and “Unit ID Settings”.

Select “Unit Scan” to display the system’s units’ status, including the quantity, chairman units’ quantity, delegate units’ quantity, and the translator consoles’ quantity.

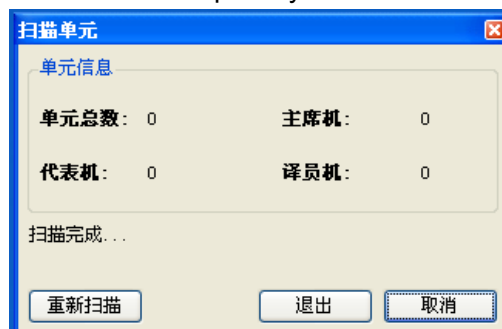

“Unit ID Settings”



◆ The units ID settings are allocating one unique address for each unit in the system for the mainframe to recognize the units.

◆ How to set the ID

After the conference system is connected, turn on the mainframe, and select: “Unit Management” → “Start allocating ID”. Now the LCD display will show as following:



:

At the same time, all units and the translator consoles will display as following:

Conference System Units display as following:



Translator consoles display as following:



Now the user need to press the unit microphone's button to set their ID one by one. The unit microphone indicator will flash for one time or keep on, which means the current ID is unique. If the unit microphone indicator flash for a few times and keep on, it means there are at least two devices having the same ID. After the ID settings are done, the units' microphone indicators will keep on. Flashing indicator means

the ID settings are not successful. After successfully set all units' ID, press “Stop ID Settings” to exit ID settings procedures.

If there are different units having the same ID, the ID settings should be performed again. The mainframe display will also show the relevant information.

When the mainframe is powered on again, it will also automatically detect whether are the duplicating IDs.

2.4.4.1.4 “WIFI Management” Options Illustration

“WIFI Management” includes “SSID/Password Settings”, “WIFI System Settings”, and “Audio Download Authorization”, which mainly are settings for the wireless WIFI system.

“SSID/Password Settings” : mainly configures the WIFI units' SSID and password. Click the “SSID/Password Settings” to bring out the following page:



After making sure the WIFI unit is connected to the AP, type in the correct SSID and password, and then click “Refresh”, the following window will pop out:



Click “Confirm” to enter the following page:



The SSID and password of the unit that has connected to the AP will be updated. The wifi unit's display will also show the successful information.

Click "Cancel" to exit the update. After making sure the WIFI unit displays the successful update information, click "Reboot". Or, turn off the WIFI unit and turn it one again, which will load the new SSID and password to all the units that have connected to the AP. New, set the AP's SSID and password to the correct value.

WIFI System Settings:

Click "WIFI System Settings", then the following window will pop up:



Audio Delay: configures the WIFI unit uploading audio delay; the optional values are: 10ms, 15ms,

18ms, 20ms, 25ms, and 30ms. Generally, 18ms is recommended. If the system does not have a very high requirement, the audio delay can be set to a higher value. 10ms is not recommended, which is only for diagnostics.

Mainframe Compatibility:

When it's under "DIG Mainframe" mode, the CR-WIFI6301 can completely comply with the DIG system. The system can have maximally 8 active microphones, and the maximal active delegate microphones can be 1/2/4/6. The WIFI system can have maximally 6 active microphones. Some times it's 4, and the wifi conference system unit may also not apply for speaking. But it will not affect the system's performance.

When it's set as "WIFI Mainframe", the CR-WIFI6301 can maximally support 6 active microphones, and the maximal active delegate microphones can only be 1/2/4.

Unit Power Saving Mode:

Enable: when there are no operations for 10 seconds, the backlight of the WIFI unit's LCD display will automatically turn off;

Disable: The backlight of the WIFI unit will keep on.

WIFI units connection status:



Click "Acquire" will show the active WIFI units' connection status. For example: if the system have 6 active WIFI microphones, and we want to test whether the system is stable, we can keep clicking "Acquire" for 30 seconds. If the microphone 1, 2, 3, 4, 5' values are not jumping (the max value is 255), then it means the system is stable. If their values are jumping between different values, please check whether their connection with the AP is ok, whether there are

obstacles between the AP and the units, whether the AP's antenna is positioned at the right direction, and whether the audio delay value is set correctly.

Audio Download Authorization:

Click “Audio Download Authorization”, the following window will pop up:



Click “Authorize”



All the units that have connected the AP will enter audio downloading status. If WIFI units display successful authorizing information, click “Stop Authorizing”, and the audio download authorization is successful, and there will audio output from the units.



Before starting the authorization, please make sure the connection between the mainframe and the WF30A is correct. Please also check whether the WF30A's “Audio” switch is on “ON” position, and whether the WIFI units are connected to the AP.

2.4.4.1.5 “Software Language” Options Illustration

From here you can set the software's language: English or Chinese.

2.4.4.1.6 “Exit” Options Illustration

Click “Exit” to close the software.

2.4.4.2 Connection and Settings Reading

After the mainframe's IP is set, click “Establish Connection” to connect to the mainframe, and the user can then set the parameters and configure the mainframe. Click “Disconnect” to stop the connection.

2.4.4.3 “Meetings Management”

2.4.4.3.1 Microphone mode



1, FIFO Mode

When the system reaches the maximal active microphone quantity, the earliest opened microphone will be turned off by the latest turned on microphone.

2, NORMAL Mode

When the system reaches the maximal active microphone quantity, the extra applying microphones will enter the waiting queue automatically. The waiting queue microphone quantity is the same as the set maximal active microphone quantity.

3, FREE Mode

Allow 6 active microphones, no waiting queue

4, APPLY Mode

The delegate units need the chairman unit's approval to speak. The waiting queue quantity is the same as set maximal active microphone quantity. Signing-in and voting will turn off the delegate microphones or clear the waiting queue.

2.4.4.3.2 Speakers Quantity



Active delegate unit quantity limitation: configures the maximal active delegate microphone quantity

to be 1/2/4/6, correspondent chairman microphone quantity 7/6/4/2. The whole system can support maximally 8 active microphones.

2.4.4.3.3 System Language



Configures the conference system units' language. Both English and Simplified Chinese are supported.

2.4.4.4 “Audio Settings” Configuration

2.4.4.4.1 DSP AUDIO EFFECTS SETTINGS AND UNIT LOUDSPEAKER SWITCH



DSP Channel 1:

Configures DSP channel 1's DSP processing algorithms, support AFC, ANC, and AGC.

DSP Channel 2: Configures DSP channel 2's DSP processing algorithms, support AFC, ANC, and AGC.

Loudspeaker Settings: "ON": the conference system units' loudspeakers will be turned on (translator consoles not included); "OFF": conference system units' loudspeakers will be turned off.

Unit DSP Processing: "ON": they system will automatically use DSP channel 1 to process the unit audio, including AFC, ANC, and AGC. When it's on, as shown in the following image, the "DSP Channel 1" will change to "Unit DSP Channel":



The system supports 2 ways audio DSP processing.

2.4.4.4.2 Volume



Line IN: adjusts the line in volume, corresponding to the mainframe's Line In 1, Line In 3, Line In 4 inputs;

Line OUT: adjusts all microphone audio line out volume;

Unit Line OUT: adjusts the microphones' original sound volume;

Video Conference System Line IN: adjusts video conference system line in volume, corresponding to the mainframe's Line In 2 input;

Treble: adjusts all microphones' treble. If the menu software "Audio Settings" –"Sound Field Selection" is "Original Sound", this adjustment is invalid.

2.4.4.4.3 Sound Field Selection



Sound Field Selection:

The system supports POP, SOFT, BASS, CLASSIC, OLD, ORIGINAL, CUSTOME, etc. sound effects. When “CUSTOME” is selected, we can enter the settings page for the gain of each bands. The value range is -20dB ~ +20dB, totally 7 bands equalization, which are 100Hz, 215Hz, 460Hz, 1KHz, 2.2KHz, 5KHz, and 11.5KHz. Click “Restore to Custom”, all 7 bands will be restored to 0dB.

2.4.4.5 Camera Settings

Camera Settings configures the presets of the camera, including protocol selection, camera mapping, and start setting three parts. First, we need to choose the camera’s protocol, then set the camera’s mapping relations, and finally enter and exit the settings.

2.4.4.5.1 Camera Protocols



There are four protocols for choice: SAMSUNG, VISCA, PELCO_D, and CREATOR, which is used to connect to CREATOR controller or the CR-MVC6300 HD camera auto-tracking system mainframe, while the camera mapping is invalid.

2.4.4.5.2 Camera Mapping



When configuring the camera mapping, first we need to select the camera ID, the corresponding camera address and matrix channel. The “Camera Address” is the control camera’s address, “Matrix Channel” is the input channel of the matrix, and the matrix’s output channel is fixed to output 1. Camera ID represents one camera. Each camera corresponds to one camera address and one matrix switcher channel. There can be maximally 16 cameras and 16 matrix channels. The camera address value is adjustable from 1 to 254, while “OFF” means it hasn’t been configured. Please set the mapping relations one by one.

2.4.4.5.3 Start Camera Settings

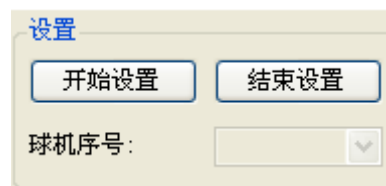

After the camera mapping is set, we start to set the camera’s presets. The camera ID is the mapping relations we mentioned above, which is adjustable. When it has been adjusted to other cameras, the matrix switcher will automatically switch the channel. Select the camera we want to configure, adjust its corresponding microphone’s presets. Turn on and off the corresponding microphone can complete the ID presets. Follow

the same procedures to finish the preset settings for all the units. Exiting the settings will use the current preset as the panorama view position. In order to reduce wrong operations, the system requires that there should be at least one ID preset to make sure exiting settings will create a panorama view preset position. Otherwise the panorama view preset is invalid.

2.4.4.6 Translation Settings

2.4.4.6.1 Automatic Channel

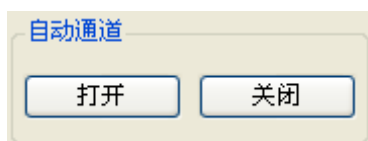

“ON”: if there is no translation, this channel will be the original sound; if there is translation, it will be translation output;

“OFF”: will not automatically switch to the original sound; if there is no translation, this channel will have no sound;

2.4.4.6.2 Total channel quantity

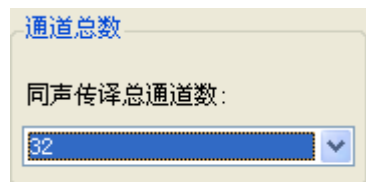

To set the total channel quantity for the translator console, maximally 32 channels;

2.4.4.6.3 Translation Room Quantity Settings

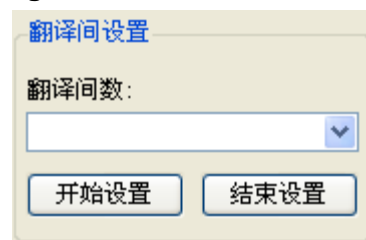

To set the translation room number. For multiple translator consoles within the same translation room: as long as one translator console

microphone is active, all other translator consoles' microphone will be turned off.

Click “Start Setting”, all translator consoles will display their current translation room number, as shown in the following image:



Turn the translator console's “SELECT OUT” knob to change the room number. After the correct value is selected, click “End Setting” to finish the translation room number settings.

2.4.4.6.4 Channel Lock



When “Channel Lock” is selected, all the translator consoles' “SELECT OUT” knob cannot be used to adjust the channel number to avoid wrong operations.

2.4.4.6.5 Channel Language



To set the language name for each translator unit.

2.4.4.7 Loudspeaker Zoning Settings

The system supports loudspeaker zoning function, every zone's microphones' output volume to the mainframe is adjustable.

2.4.4.7.1 Loudspeaker Zoning Function Switch

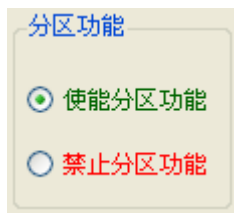

When this function is disabled, all line out volume is controlled via “Audio Settings” → “Line Out”. All four mainframe outputs are the same, and it is default that they will be processed using “DSP Channel 1”. When it is enabled, each zone’s microphones audio output the the mainframe can be adjusted independently.

2.4.4.7.2 Microphone Zoning



This function supports maximally 4 zones, which cannot overlap with each other. Each microphone has only one zone. The maximally ID value is 4000. In the above image, it means that ID 1~100 belong to Zone 1, 101~200 belong to Zone 2, 301 ~ 4000 belong to Zone 4.

2.4.4.7.3 Loudspeaker Zoning Gain Control



OUT 1 Gain:

Video Conference Output: select video conference system output, the mainframe’s OUT 1, which is the mainframe Line OUT phoenix interface’s left sound track can connect to video conference system terminal. The corresponding video conference terminal output audio will not go back to the input end.

OUT 2 Gain:

Similar to OUT 1 Gain;

OUT 3 Gain:

Similar to OUT1 Gain;

OUT 4 Gain:

Similar to OUT1 Gain;

DSP Channel 1: select “DSP Channel 1”, this OUT output is processed via “DSP Channel 1” and outputting;

DSP Channel 2: select “DSP Channel 2”, this OUT output is processed via “DSP Channel 2” and outputting;

Zone 1: Zone 1 microphones to OUT1 gain

adjustment, the range is: mute, -40dB ~ 0dB;

Zone 2: Zone 2 microphones to OUT1 gain adjustment, the range is: mute, -40dB ~ 0dB;

Zone 3: Zone 3 microphones to OUT1 gain adjustment, the range is: mute, -40dB ~ 0dB;

Zone 4: Zone 4 microphones to OUT1 gain adjustment, the range is: mute, -40dB ~ 0dB;



For each output interface, there can only be one DSP processing, supporting maximally 2 ways audio processing. When the “Unit DSP Processing” is on, only “DSP Channel 2” can be used.

2.4.5 ID BUTTON

The ID button is used for the entering or exiting the wifi conference system’s ID setting function.

Press and hold the ID button for 5 seconds, the button indicating light will be turned on, and the LCD will show “SYSTEM SETTING”, which means the system already entered the ID settings mode. Press or press and hold the ID button again to exit the ID Settings mode.



For the detailed operations please refer to the following ID settings steps.

2.5 ETHERNET Cable Wiring

Instructions

For this system, CAT5 cable will be used as the system connection cable. It connects the equipment on both ends with RJ45 interface (the crystal interface). The standard wiring methods of the twisted-pair cable is to ensure the symmetry of the internal wires, in which way, the interferences can cancel each other. Generally, there are 4 pairs twisted fine lines in uCAT5 cable, which are market with different colors. There are two wiring methods for twisted-pair cable: EIA/TIA 568B and EIA/TIA 568A.

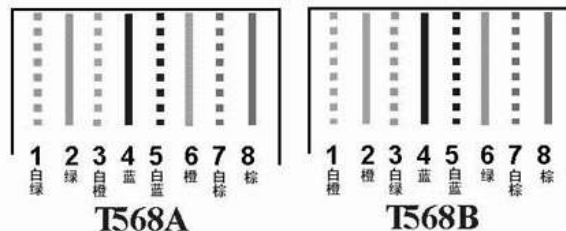

T568A Line Sequence							
1	2	3	4	5	6	7	8
G W	G	O W	B	B W	O	Bro wn W	Bro wn

T568B 线序							
1	2	3	4	5	6	7	8
Ora nge Wh ite	Ora nge	Gre en Wh ite	Blu e	Blu e Wh ite	Gre en	Bro wn W hit e	Bro wn

Through Line: both ends’ connection should follow the T568B line sequence;

Cross Line: one end’s connection following the T568A Line Sequence, while the other end using T568B Line Sequence.



当连接网络路由器的时候，采用交叉线接法，当连接 PC 电脑控制时，采用交叉线接法。

Cross line is used for connection to the network router.

Cross line is used for managing PC.

2.6 CONTROL SYSTEM COM PIN

Definition

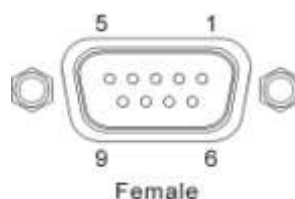

	PIN	Signal	Description
Control System	1	—	—
	2	RXD	Receive Data
	3	TXD	Send Date
	4	—	—
	5	GND	Signal Ground
	6	—	—
	7	—	—
	8	—	—
	9	—	—

installed onto standard 19" equipment cabinet. Within its package, there is 1 pair installation racket. The installation guidance is as following:

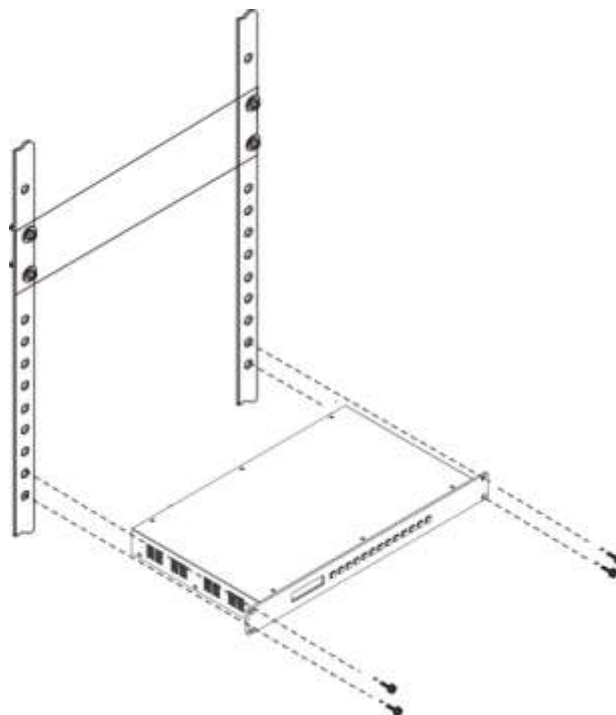

2.7 AUDIO OUTPUTS

3.5mm Audio Interface Wiring

Instruction

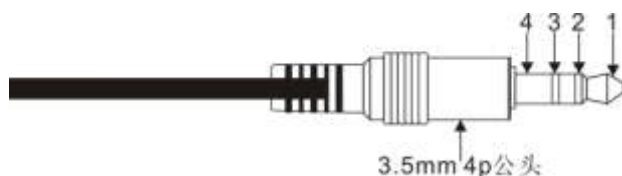

PIN	SIGNAL	Description
1	AU+	Audio Signal+
2	AU-	Audio Signal-
3	SIG	Control Signal
4	GND	Signal Grounding



The wireless AP's AUDIO interface pin definition is the same as above.

Audio cable with shield should be used for the connection between this interface and the AP to ensure the audio transmission quality.

2.8 CR-WiFi6301 Mainframe

Installation

The WiFi conference system mainframe can be

2.9 CR-WiFi6301 Technical

Specifications

Model Type	CR-WiFi6301
Network Interface	RJ45
Control Interface	DB9 male
Display	1602LCD Display
(S/N)	>80dB
T.H.D	<0.05%
Quiescent Power Consumption	12W
Max. Power Consumption	150W
Dynamic Range	>80dB
Frequency Response	20Hz~20KHz
Communication distance between the mainframe and the AP	<100m
Dimensions	483LX290WX43.6H (mm)

Model Type	CR-WiFi6301
Power (America and Japan)	AC100V~AC120V 60Hz
Power (Euro and Asia Continent)	AC200V~AC240V 50Hz

Chapter Three Wifi Conference System Unit

3.1 General Introduction

CR-WIFI6302/04B has adopted special craftsmanship design to ensure the stability and durability. They can be integrated with any meeting room.

They have built-in antenna design. High performance battery set is equipped within each unit, which provide 9 hours continuous speaking time and 13 hours' standby time. All the units' functions can be operated via the panel buttons. The encrypted WiFi transmission technology ensures that the speaking won't be intercepted by unauthorized parties.

3.2 CR-WiFi6302/4B Front Panel

Top View:

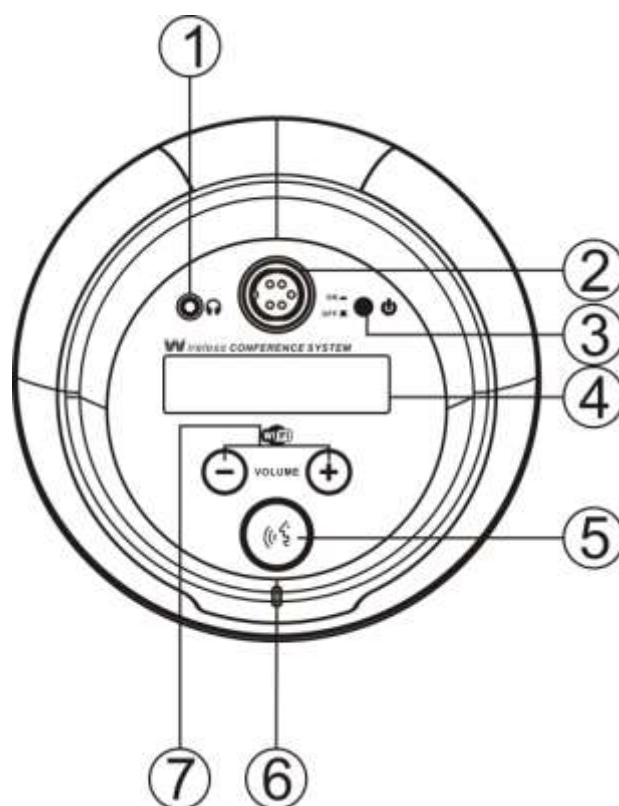

Bottom View:

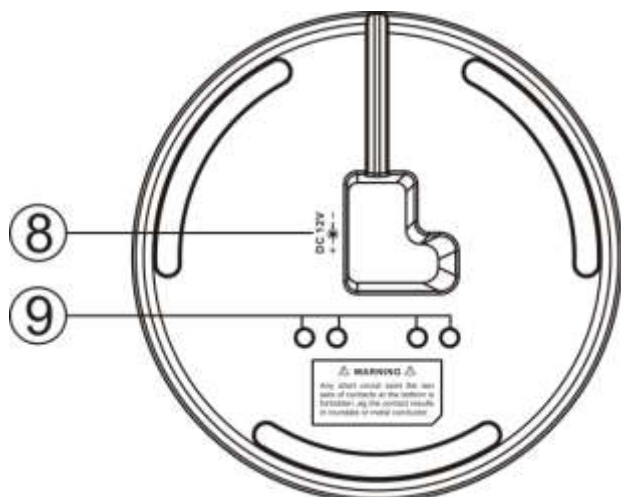

① Earphone jacket, with earphone plugged in, the speaking person's voice can be heard.

② Plug style microphone base station (microphone interface): 5-pin high density aviation interface; screw cap interface connection for more stable connection.

③ Unit power button: press down this button will turn on the unit, and the power indication will be lit up. The unit then enters working status.

④ LCD display: white characters with blue backlight, showing relevant operations' information.

⑤ Microphone speaking function switch : press this button and the microphone's indicator ring will be turned on in red color

⑥ Power Indicator

⑦ Volume adjustment buttons, they can adjust both the earphone and the loudspeaker's volume.

⑧ Power supply interface, system power input for DC 12V auto adaptive.

⑨ Conference unit charging interface: there are four interfaces to match the charging socket in

the charging box;

3.3 CR-WiFi6202/4B Function

Features

- ◆ Wi-Fi transmission technology; strict digitalized protection to ensure the conference's confidentiality, and to avoid eavesdropping and malicious interference.

- ◆ capacitive cardioid directional microphone with dual color indicating ring: red for speaking, and flashing green color for insufficient power;

- ◆ Built with one 3.5mm stereo earphone jacket; support volume adjustment;

- ◆ Built-in loudspeakers; support volume adjustment;

- ◆ LCD display with backlight, which can show the information of microphone ON/OFF, ID settings, etc.

- ◆ non-compressed audio transmission technology; 48K sampling rate; 20Hz ~ 20KHz bandwidth; perfect audio quality;

- ◆ Working with CREATOR high definition camera auto-tracking mainframe and HD IR auto-tracking camera to realize camera auto-tracking function;

- ◆ Support managing the microphones with PC software; support FIFO, APPLY, and NORMAL modes, etc.

- ◆ The chairman unit has the priority to turn off the delegate units;

- ◆ Built-in rechargeable lithium battery, support 9

hours continuous speaking or 13 hours standby time;

- ◆ Special purpose 5-pin high density aviation interface;
- ◆ Professional conference microphone with screw cap interface for freely plug;
- ◆ Built-in magnetic loudspeaker
- ◆ Support hawl suppression function: when the microphone is turned on, the built-in speaker will be turned off automatically to avoid sound feedback.

3.4 CR-WiFi6302/4B Operation

3.4.1 CR-WiFi6302/4B SSID and Security Key settings

1. Restore to factory default settings

When the unit is powered up, press and hold the “+” and “-” buttons at the same time, then the unit will enter the following menu:



Press the “-” button to cancel restoring to default factory settings



Press the “+” button to restore to default factory settings

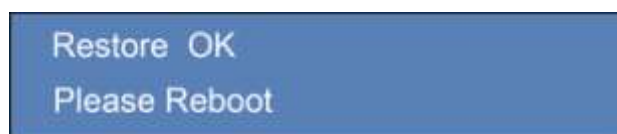

The default factory settings value is: SSID : CREATOR; Password: 12345678;

Set the AP's SSID to be CREATOR, its KEY to be 12345678;

Restart the unit. Now the unit will connect to the AP. Connect the AP to the conference system mainframe using a network cable.

To set the SSID and Password for the conference system mainframe: operate on the menu software: “WIFI Management” → “SSID/Password Settings”.



Click “Update”, and then the unit will enter the following interface:



It means the SSID and KEY settings are done, reboot.

Change the AP's SSID and KEY to the new values, reboot.

Now the units will connect to the AP.

3.4.2 CR-WiFi6302/4B ID Settings

Before using the WIFI conference system for the first time, you need to set ID for all the units to make sure the units can connect to the AP. Press and hold the “ID” button on the mainframe's front panel to enter the ID editing mode, and now the units will show the following message:



Local ID: 0007
Current ID: 0001

Press and microphone speaking button, and the unit will get correspondent ID.

LOCAL ID: the current unit ID;

Current ID: the current down-issued ID from the mainframe;

After the mainframe exit ID settings mode, the unit display will show the following message.

Reboot the unit to complete ID settings.



ID Updated
Please Reboot

3.4.3 CR-WiFi6302/4B Audio Downloading Settings

To start the authorization: through the mainframe's menu software: "WIFI Management" → "Audio download authorization"

The unit display will enter the following interface:



Chairman Unit
Authorizing. . .



Delegate Unit
Authorizing. . .

The authorization is complete, and the following interface will pop out:



Delegate Unit
Authorizing Done



Chairman Unit
Authorizing Done

The mainframe is authorizing, and after it is complete, there will be sound output from the

unit's earphone jacket.



Delegate Unit
Mic Off

3.4.4 CR-WiFi6302/4B Other Commonly used settings

Under the APPLY mode, the applying delegate unit display will show as following:



Apply For Mic
Please Wait...

And now the chairman unit display will show as the following:



Applying Mic: 1
Disagree Agree

It means there is one applying microphone. The "-" button on the chairman unit will cancel the application, and the "+" button can approve the application, which will then turn on the applying delegate unit.

The powering up steps will show as following:



CREATOR
WIFI CONFERENCE



CREATOR
Connecting

Failed to connect to the AP, as shown in the following image:



Scan AP Error
Please Reboot

The following images shows that the connection

to the AP is successful, and the unit enters normal mode. The microphone is in OFF status.

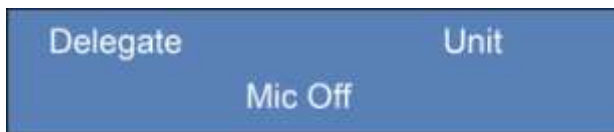

The following images shows that the connection between the chairman unit and the AP is successful, and the unit enters normal mode. The microphone is in OFF status.



The following image shows the chairman unit's "priority function":



The following images means that the chairman microphone is turned on:

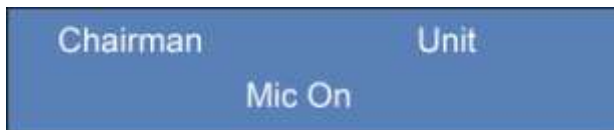

The following images mean that the delegate unit is already turned on:



3.4.5 How to Use CR-WiFi6202/4B

After the first time usage and the ID being successfully set, only powering on will be needed for the system to work. The units will initialize first, then will automatically connect to the AP, and the system start to work.

When the system is turned on and working, press

down the speaking button on the unit, the indicating ring will turn on in red color. Now the users can use the microphone for speaking.

Under NORMAL mode, when the quantity of the turned on microphones reaches the set value of ACTIVE MICRO's, the following microphones will enter applying mode.

Under FIFO mode, when the quantity of the turned on microphones reaches the set value of ACTIVE MICRO's, the next microphone will automatically turn off the first turned on microphone, and so on.

The chairman unit will not be turned off by the delegate unit.

Press and hold the chairman microphone's speaking button will turn off all active microphone. The volume adjustment button can adjust both the earphone and the loudspeaker's volume. Press down the "-" and the "+" button at the same time will bring the unit's IP and AP information to the unit's display.



Please make sure the units are within 30 meters radius of the AP to make ensure perfect connection.

3.5 CR-WiFi6202/4B Technical specifications

Model Type	CR-WiFi6202/04B
Connection Interfaces	
Button	Pluggable base for the microphone
Earphone Jacket	1 3.5mm (0.14 inch) stereo earphone jacket
Power Supply	DC power supply input (can be used when the battery set is taken away)
Electronic Specifications	
Frequency Response	30Hz~20kHz
Earphone Load	>32Ohm <1K Ohm

Model Type	CR-WiFi6202/04B
Impedance	
Loudspeaker Output Power	2×15mW/32 Ohm
Wireless Specifications	
Standard	IEEE Draft 2.0 802.11n
Wireless Frequency Range	4.900-5.850GHz
Radiation Power	15dBm
Wireless Gain	2dBi
Specifications	
Batter Output Voltage	7.2V
Battery	3200mAH

Model Type	CR-WiFi6202/04B
Capacity	
Continuous Speaking Time	9 Hours
Max. Standby Time	13 Hours
Max. Charging Time	3 Hours
Color	Black
Max. Power Consumption	2.6W
Dimensions	Φ=165 H=64 (mm)

Chapter Four, Wireless AP

4.1 General Introduction

The CR-WF30A is a wireless router. It provides the connection between the wireless conference system units and the mainframe, which is a convenient, flexible and reliable solution for the wireless conference system.

4.2 CR-WF30A Front Panel

Side View 1:

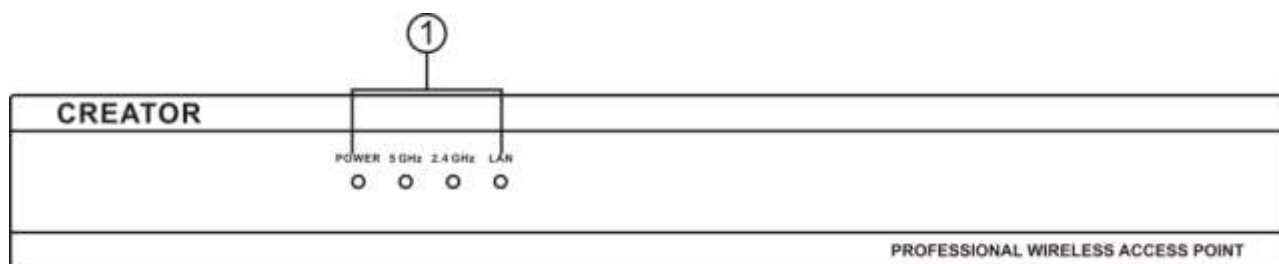

Top View:

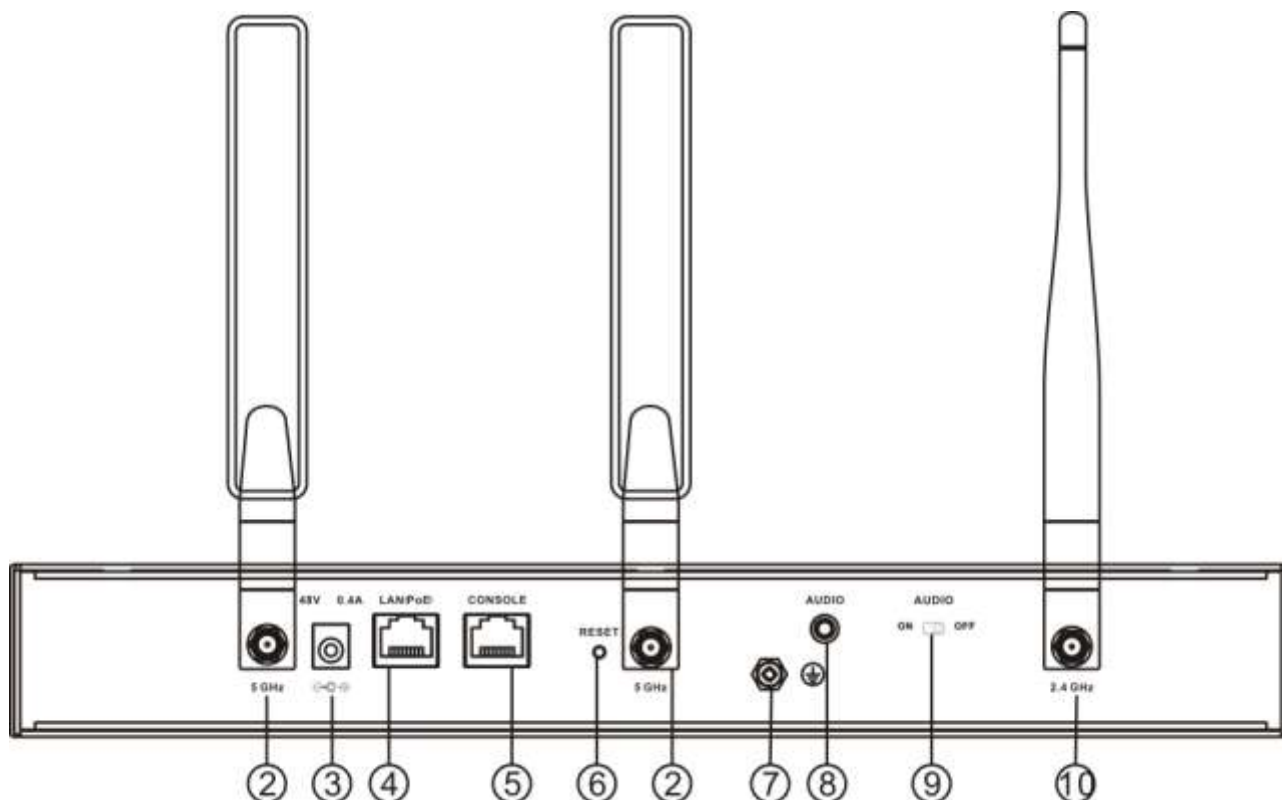

① POWER

Power indicator, when it is successfully powered on, the indicator will be on, otherwise it's off.

5GHz

5GHz wireless network signal indicator. When the 5GHz wireless network signal passes through, it will flash, meaning there is signal communication.

2.4GHz

2.4GHz wireless network signal indicator. When the 2.4 GHz wireless network signal passes through, it will flash, meaning there is signal communication.

LAN

2.4GHz

Ethernet signal indicator. When the Ethernet signal passes through, it will flash, meaning there is signal communication.

② 5GHz Antenna

One pair of 5GHz freely rotatable antenna for

adjusting to the best radiation/receiving range.

③ DC 48V

DC power supply interface: the mainframe supports DC48V power supply.

④ LAN (PoE)

Ethernet interface for connection to WIFI conference system mainframe or network switch.

⑤ CONSOLE

Control console, used for setting different 5G bands for different countries and areas.

⑥ RESET

Reset button. Press and hold this button for 10 seconds will restore the machine to its default factory settings.



The reset button will clear all customer settings and restore to default factory settings, which will include all wireless

security, IP address settings. After reset, the IP address will be 192.168.0.50; user name will be: admin, and the password will be none.

⑦ Grounding Interface

⑧ AUDIO

Balanced audio input interface, for connection to the conference system mainframe

⑨ AUDIO ON/OFF

AUDIO ON/OFF is used to turn on or off the wireless AP's 2.4G bands.

⑩ 2.4GHz Antenna

One pair of 2.4GHz freely rotatable antenna for adjusting to the best radiation/receiving range.

4.3 CR-WF30A Function Features

◆ Adopted WPA/WPA2 digital encryption for Wi-Fi signal transmission, ensures the confidentiality of the meeting, and avoid eavesdropping and malicious interference.

◆ One RJ45 interface for connection to CR-WiFi6301 mainframe or network switch. High quality cross CAT5 cable is recommended for the connection.

◆ One 4 lines 3.5mm interface for connection to the CR-WiFi6301 mainframe, providing 1 way balanced audio and control signal input;

◆ The coverage is 30 meters radius in spacious area with little interference; common coverage area is 25 radius circle.

◆ Compatible with IEEE802.11n WIFI network standards;

◆ Three antenna design ensures the data transmission stability.

4.4 CR-WF30A Settings

Step 1.

Connect the CR-WIFI30A's LAN port (PoE) to the computer with a network cable, and set the PC's IP address to be within the same range as the router's. For example: if the router's IP address is 192.168.2.1 (default), then the PC's IP address should be 192.168.2. (0~255).

First open "LAN" under "Network Settings" on PC, then choose "Internet Protocol (TCP/IP)". Click "Properties" to enter IP settings interface, as shown in the following image 4-1:

Step 2,

After the settings, launch IE explorer, type in 192.168.2.1 and press Enter, as shown in image 4-2.

If the IP is correct, it will pop out the router's login page. Now type in the user name admin, and leave the password empty. Press Enter to confirm, as shown in image 4-3:

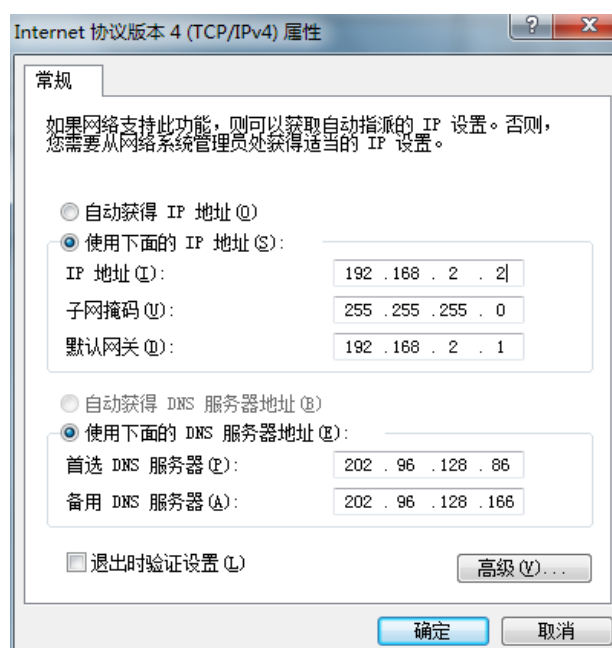

Image 4-1

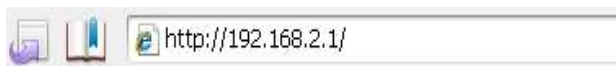

Image 4-2



Image 4-3

Step 3,

Enter the CR-WF30A's settings page as shown in the following image.

The main settings include: Basic Settings, Advanced Settings, and Administration Settings.



图 4-4

4.4.1 Basic Settings

There are Wireless Settings and LAN Settings (as shown in image 4-4)

◆ Wireless

Wireless Settings: used for setting wireless frequency, wireless mode, SSID, wireless channel, and wireless password.

Wireless Band: 2.4GHz/5GHz Optional. 5GHz should be chosen for WIFI conference

system.

Mode: Wireless Mode, choose Access Point

Network Name (SSID): SSID, the name that will be shown in all shared network. For the WIFI conference system, the SSID is fixed to be CREATOR.

SSID Visibility: Please set to be "Enable"

Auto Channel Selection: 此项为是否自动选择无线信道。当选择"Disable"后，在下一选项中选择 a channel without interference; when it's not sure whether there is interference, choose "Auto";

Channel: Channel selection; you have to choose a channel that has no or little interference, otherwise the WIFI system will be interfered.

Channel Width: this setting will directly affect the maximum network transmission speed. When "20MHz" is selected, the max transmission speed is 15Mbps; when "40MHz" is selected, the max transmission speed is 300Mbps; "Auto 20/40 MHz" is recommended.

Authentication: Password verification type. To ensure the data security, WIFI conference system's password verification type is fixed to be "WPA-personal".

WPA Mode: WPA is an enhanced WLAN security solution based on standard and interaction, which can greatly improve the current and future wireless LAN's data protection and access control level. In order to improve the data security level, WIFI conference system locks this value to be "WPA2 Only".

Cipher Type: The cipher type is fixed to be "AES".

Group Key Update Interval: AES/TKIP password switching cycle. As the former item has been fixed to be "AES", the value for this item can be kept to its default value. Choose the password switching value to be "Manual",

self definition.

PassPhrase: Password for the conference system units connecting to the wireless AP. Here its value is fixed to be “12345678”.

Confirm PassPhrase: To confirm the password. Type in the password from the former item again.

Till now all the settings are done. As shown in the following image:



Image 4-5

Click  to save the settings.

◆ LAN

Network settings: set the IP address under this option.

LAN Settings:

Select fixed IP address (default). If you want to designate a static IP address or fixed address, you need to follow the following steps:

Choose “Static IP (manual)” from the drop down menu of “Get IP From”:

Local IP Address: Within the same network, the IP address should be unique. The system default value is 196.168.2.1

Subnet Mask: within the same network, the subnet mask should be the same; the system default value is 255.255.255.0

Default Gateway: this item can be left blank

As shown in the following image:



图 4-6

Click  to save the settings.

4.4.2 Advanced Settings

Under the advanced settings, user only need to set the Performance item, and the Dynamic Pool Settings item under the DHCP Server. All other values should be kept as default factory settings.

4.4.2.1 Performance

In a WIFI wireless conference system, the AP should be set to work on 5GHz bands.

◆ 5GHz Wireless Bands Settings

Only the follow items should be configured, others should be kept with their default value.

Wireless band : Wireless AP frequency selection: 5GHz.

Wireless: Please select “On” to turn on 5GHz frequency

Wireless Mode: Please select “802.11n Only” mode; the max speed is 300Mbps.

Beacon Interval (25-500) : Please set the value to be “25”. This value will affect the downloading audio’s quality, please make sure it is the minimum value.

WMM (Wi-Fi Multimedia) : Enable
All the performance settings now are done, as shown in the following image:

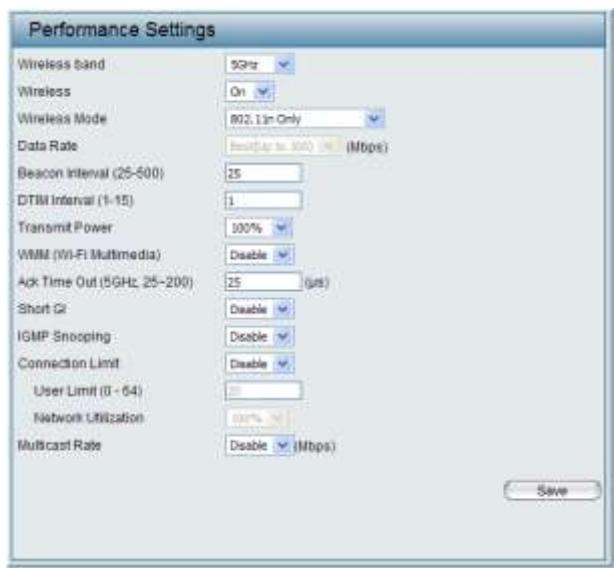

Image 4-7

Click the “Save” button on the bottom right corner to save the settings.

Once the AP’s 5GHz frequency bands are open, the 2.4GHz bands should be turned off to make sure the AP works on 5GHz frequency. The settings steps are as following:

Wireless band: 2.4GHz

Wireless: Select “Off” to turn off the 2.4GHz frequency.

Now the 2.4GHz frequency is turned off, and its other settings options are invalid, and can be kept with their default value. Click the “Save” button on the right bottom corner to save the settings.

4.4.2.2 Dynamic Pool Settings

In the WIFI conference system, the AP is not using DHCP to allocate IP to each conference system units. Please follow the steps: “Advanced Settings” → “DHCP Server” → “Dynamic Pool Settings” to disable DHCP function, as shown in the following image:



Image 4-8

Click the “Save” button on the right bottom corner to save the settings.

4.4.3 Administration Settings

This item is under the “Maintenance” menu. There items are: Limit Administrator, System Name Settings, Login Settings, Console Settings, and SNMP Settings Ping Control Setting, as shown in the following image:



Image 4-9

Login Settings: Here the user can reset the username and password. CREATOR recommends the user to keep the default username and password for easier later

maintenance.

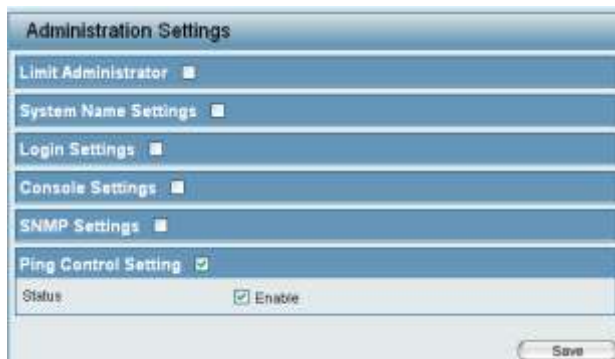

Image 4-10

Ping Control Setting: To ensure the normal communication between the router and the mainframe, please make sure the value is set to be “enable”. Click the “Save” button on the right bottom corner to save the setting

4.4.4 Save the Settings

When all settings are done and saved, click the “Save and Activate” button under the “Configuration” item of the main menu to reboot the router to bring all previous settings to effect.

4.5 Connection Diagram

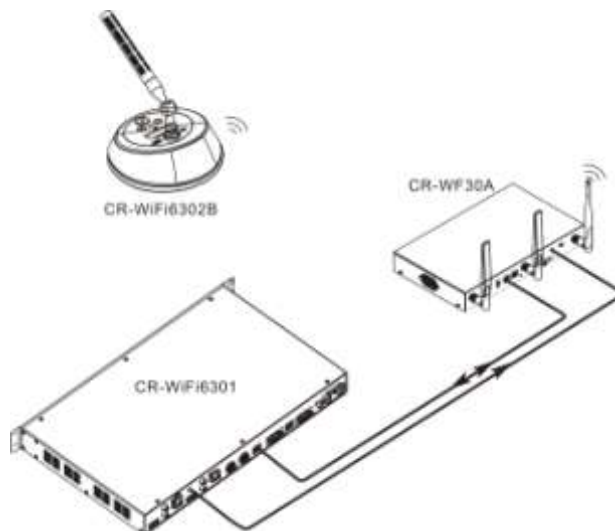

4.6 Technical Specifications

Model Type	CR-WF30A
Network Standard	IEEE Draft 2.0 802.11n
Network Interface	10/100Base-T
Wireless Frequency Range	5GHz (Chinese standards: 5.725GHz to 5.85GHz)
Data Transmission Speed	Max 300 Mbps
Radiation Power	802.11N:17dBm
Antenna	2.4G:3dBi, 5G:5dBi
Connected Units Quantity	Within the AP's effective range, one AP can be connected with at most 50 units
Signal Coverage	The coverage is 30 meters radius in spacious area with little interference; common coverage area is 25 radius circle.
Power Supply	DC48V
Working Temperature	0°C~40°C
Max. Power Consumption	19W
Dimensions	324L×203.7W×43.6H (mm)

Chapter Five, System Settings

5.1 System ID Settings

Before the first time usage, the user has to set the ID first for the WIFI conference system. The ID settings can allocate IP addresses for each unit, and complete the matching between the AP and the units. The detailed steps are as following:

5.1.1 Wireless AP Settings

The AP should be configured first before setting the system ID. Before the first time usage, please set the AP SSID to "CREATOR", and the Password to "12345678".



1. In a system having more than one AP, each AP should be allocated with a unique address, the value range is: 192.168.2.243 ~ 192.168.2.254.
2. When there are more than one AP, within a 30 meters' radius range, only one AP's audio downloading function can be turned on with the AUDIO ON/OFF switch.

5.1.2 System Connection

Assemble the system according to the different interfaces, and then power the system up.

5.1.3 Conference System Unit Settings

Step One, restore the WIFI conference system unit to its default factory settings, and then reboot. Press down the power switch of the unit to turn it on. At the same time, press and hold the "+" and "-" buttons together.



Press the "+" button to restore to factory settings

and reboot the unit. The unit will enter:



It means the AP connection is successful, if the connection is not successful, please check whether the AP's settings are correct.

Step Two: change unit SSID and Password, and Reboot.

Step Three: Change the AP's SSID and Password to be the same as the units', reboot.

Step Four: If audio downloading is needed, configure the mainframe for this function.

5.2 Camera Auto-tracking Settings

The WIFI conference system mainframe supports camera auto-tracking function. The supported protocols are CREATOR, PELCO-D, PELCO-P, and VISCA.

5.2.1 Settings Steps

Step One System Connection

Through the RS232 interface, the WIFI conference system mainframe can work with CREATOR camera auto-tracking system mainframe, third party controller or connecting to cameras directly.

The WIFI conference system mainframe's RS232 baud rate is fixed to be 9600bps, which should also be supported by third party cameras or other devices.

Step Two, mainframe working mode settings

Enter the MODE settings menu and set WIFI

conference system mainframe to be FIFO mode. Enter the ACTIVE MICRO's settings menu, and set the maximal active speakers quantity to be 1.

Step Three, Mainframe Camera Menu Settings

With the front panel button "MENU" of the mainframe, select the "CAMERA" option, and press "ENTER" to enter the settings. The LCD display will show as following:

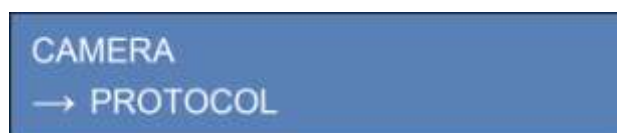

Press the "▶" button once, and the LCD display will show as following:

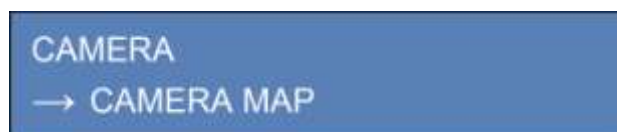

PROTOCOL Menu is used to select the camera control protocol;

CAMERA MAP Menu is used to set the camera address and matrix switcher channel;

START SET menu is used to set the camera presets.

Before configure the presets, please select the camera control protocol first. As shown in the above "PROTOCOL" interface, press "ENTER" to enter control protocol settings menu, as shown in the following image:



Press "◀" or "▶" to select the right protocol, and then press "ENTER" to confirm.

There are four protocols available: SAMSUNG, VISCA, PELCO_D, and CREATOR. CRATOR protocol is used to work with CREATOR controller or CR-MVC4200 camera auto-tracking system mainframe.

Before the configuring the presets, camera mapping should also be set for the matching between the camera address and the matrix channel.

Step Four, Start the presets settings

After selected the correct protocol following the above steps, press "MENU" to return to the upper level menu, then press navigation button "▶" select "START SET" option. Press "ENTER" to enter presets settings, as shown in the following image:

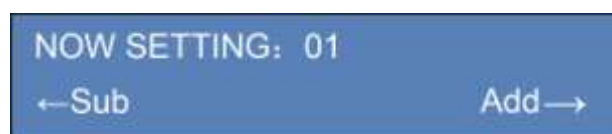

The system now is already under presets configuration status. Press "◀" or "▶" to select different cameras to configure their presets.



When the CREATOR DEF. protocol is selected, preset settings are invalid. Please refer to the CREATOR camera auto-tracking mainframe settings guidance for the relevant operations.

Step Five, Presets Settings

Select the camera first, then use the camera remote to move the camera to the right position with the right angle and zoom. Press the microphone's speaking button, the indicating ring will turn on in red color. Press again the speaking button the indicating ring will turn off, the presets then are saved.

Follow the above steps to set the presets for all other units one by one.

Before exiting presets settings, adjust the panorama view angle and zoom, and then press the “MENU” button to exit the presets settings.

Now all the presets settings are done.

5.3 Settings for Adding

Conference System Unit

After the system initializing settings are successfully done, if there is new unit going to be added into the system, all previous settings do not need to be changed. Only the following steps are necessary to add a new unit:

Step One:

System power on, and make sure all existing units are working properly.

Step Two:

Follow the same steps to set the ID for the newly added unit. All previous units don't need ID settings again.

Step Three:

After the ID settings for the newly added unit, configure the camera presets settings for the newly added unit. All previous units don't need presets settings again.



During the presets settings, since the unit microphone turning off will update the preset for the panorama view, the panorama view preset need to be set again after the preset settings for the last unit.

After all the above steps are completed, the newly added unit will be successfully integrated into the existing system. All previews settings have not been changed.

Chapter Six, System Diagram

6.1 System Connection Diagram with One AP

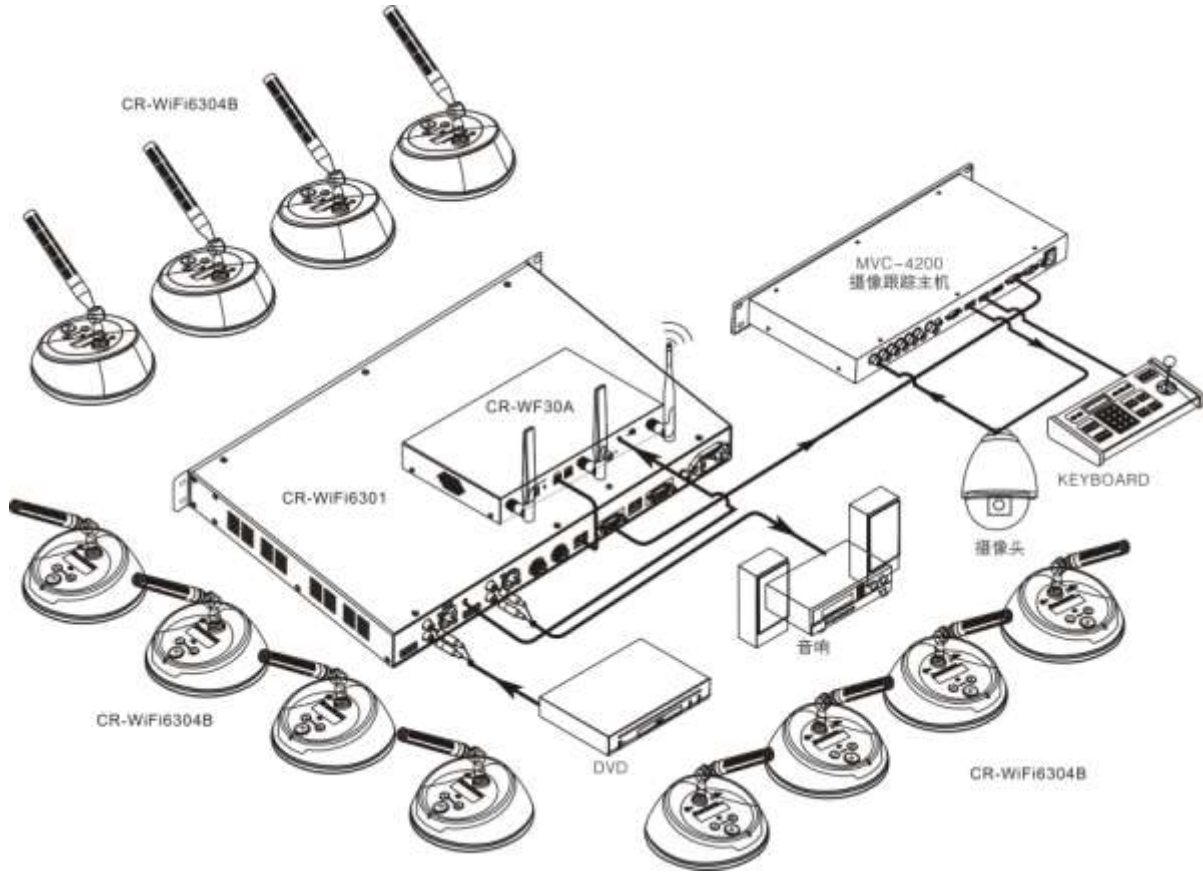

6.2 System Connection Diagram with more than One Wireless AP

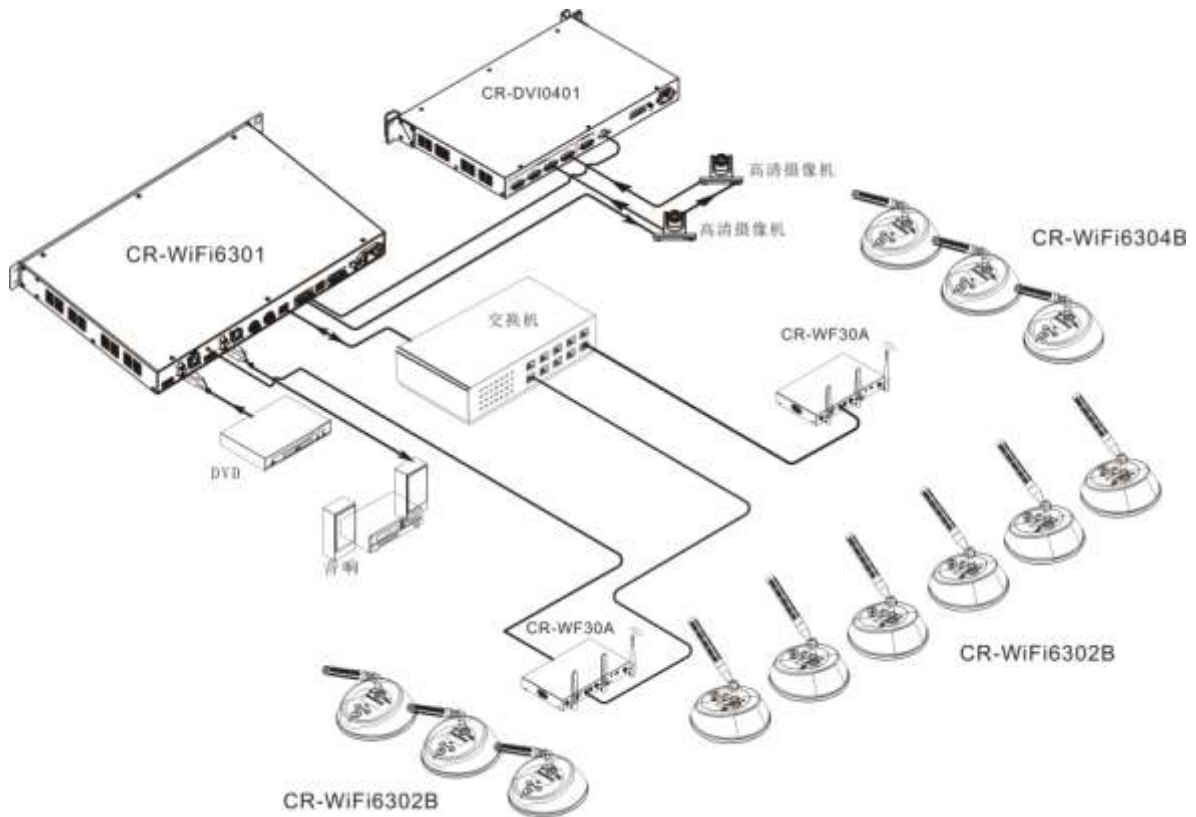

When there are more than one wireless AP, the following points should be minded:

1. Different APs should be set with different SSID, and their 5G signal channels should also be separated. When one AP is set with 192.168.2.1, other APs' addresses need to be changed, within the range: 192.168.2.245~192.168.2.254;
2. Working with the wireless AP's AUDIO ON/OFF to make sure the AP's 2.4G RF won't interfere with each other.

Chapter Seven, Accessories

7.1 Charging Case

The CR-WFDS06 can be used to charge the units. One case can charge 6 units at the same time. The power supply support daisy-chain connection. Swift charging function is supported. The maximum charging time is 3 hours.

Charging Schematic Diagram:



Features and Advantages:

- ◆ Support charging 6 units at the same time;
- ◆ Universal power supply;
- ◆ Power input support daisy-chain connection;
- ◆ Swift charging function: maximum charging time 3 hours;
- ◆ The charging case can also be used to store the units;

Controller and Indicator

- ◆ ON/OFF;
- ◆ Charging Status Indication;

Interconnection

- ◆ Power supply connection interface: Euro type; male plug;
- ◆ 24 charging pin;

Technical Specifications

Dimensions	497LX397WX120H (mm)
Weight	About 5kg
Power	100W

Consumption	
Power Consumption (Standby)	3W

Charging Box Daisy-chain Connection Diagram:

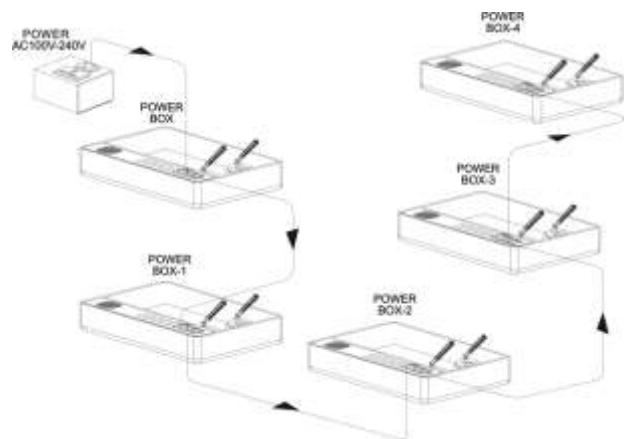

7.2 CR-P2 Headphone



Functions Description:

- ◆ Can be used on conference system units for monitoring;
- ◆ Avoid affect others during a meeting;
- ◆ Built with 1.5 meters long cable;
- ◆ High fidelity audio quality;

Technical Specifications:

Unit Interface	3.5mm mono plug
Frequency Response	30Hz -16KHz
Sensibility	90dB
S.N.R.	> 80dB
Distortion	< 0.1dB
Impedance	32 Ω
Dynamic Range	> 85 dB

7.3 CR-W6KL215B 215mm

Cardioid Folding Microphone



Functions Description:

- ◆ Capacitive cardioid directional microphone;
- ◆ High density 5 pin aviation interface;
- ◆ Speaking indicator;
- ◆ Applying for speaking indicator;

7.4 CR-M4KL415 knob-style

415mm microphone (optional)



Function Description:

- ◆ Capacitive cardioid directional microphone;
- ◆ High density 5 pin aviation interface;
- ◆ Speaking indicator;
- ◆ Applying for speaking indicator;

7.5 CR-DOCK10B Wireless

Conference System Unit Charging

Dock (Optional)



Function Description:

- ◆ Charging the wireless conference system unit;
- ◆ 4 non-slip mats for fixing onto desktop to charge while in use;
- ◆ Charging indicator;

7.6 Power Adaptor



Function Description:

- ◆ Used for charging and supplying power for the unit;
- ◆ INPUT 100V-240ac--1.5A;
- ◆ OUTPUT DC12V--3A。

7.7 RS-232 Communication Cable

Function Description:

- ◆ Used to connect to mainframe, camera, and video matrix switcher to realize the control signal connection for the camera auto-tracking function;



Chapter Eight, Accessories

8.1 CREATOR Conference System Protocols Format and Description

Protocol: 9600, N, 8, 1

Control Codes: all the following codes are in Hex format;

Format: A0 [XX] 10 00 07 [YY] FF FF FF AF [ZZ]

Description:

- ◆ [XX], [YY] and [ZZ] are all in Hex format, which [YY] represents ID mapping code;
- ◆ Algorithm: $[ZZ]=FFFF-([XX]+10+00+07+[YY]+FF+FF+FF)$, results using low digital position;
- ◆ Adopted “128-decimal” algorithm, each 128 increase in the speaking unit’s number (serial number) will result in 7F increase for the ID mapping code; ID mapping code [YY]’s high digital position will move left for 1 position, at the same time [XX] increase 1. If the speaking unit’s number (serial number) keeps increasing, then [YY] will start from 0 again, while [ZZ] will following the algorithm before; as shown in the following table:

Speaking Unit’s ID (Decimal Format)	Return Code’s ID Mapping Code (Hex format)	Serial Port’s Return Code (Hex format)
001	1	A0 10 10 00 07 01 FF FF FF AF DA
002	2	A0 10 10 00 07 02 FF FF FF AF D9
003	3	A0 10 10 00 07 03 FF FF FF AF D8
004	4	A0 10 10 00 07 04 FF FF FF AF D7
...
127	7F	A0 10 10 00 07 7F FF FF FF AF 5C
128	100	A0 11 10 00 07 00 FF FF FF AF DA
129	101	A0 11 10 00 07 01 FF FF FF AF D9
130	102	A0 11 10 00 07 02 FF FF FF AF D8
131	103	A0 11 10 00 07 03 FF FF FF AF D7
132	104	A0 11 10 00 07 04 FF FF FF AF D6
...
255	17F	A0 11 10 00 07 7F FF FF FF AF 5B

The above table shows the matching relations between the speaking unit’s ID (serial number), ID mapping Code, and the serial port return codes;

8.2 PELCO-D Camera Control Protocol and Format Description

Communication Protocol: 9600, N, 8, 1

Control Codes: All the following codes are in Hex format;

PELCO-D Codes Format:

Byte 1	Byte 2	Byte 3	Byte 4	Byte 5	Byte 6	Byte 7
FFH	Address Code	Command Code 1	Command Code 2	Data Code 1	Data Code 2	Check Code

Description:

- ◆ Address Code is the camera's logic address number, which is fixed to be: 01H;
- ◆ Algorithm: Check Code= MOD[(Byte 2 + Byte 3 + Byte 4 + Byte 5 + Byte 6) /100H];

Codes to configure the camera presets:

Byte 1	Byte 2	Byte 3	Byte 4	Byte 5	Byte 6	Byte 7
FFH	01H	00H	03H	00H	Preset Number	Check Code

Codes to invoke camera presets:

Byte 1	Byte 2	Byte 3	Byte 4	Byte 5	Byte 6	Byte 7
FFH	01H	00H	07H	00H	Preset Number	Check Code

The preset number in the above table is the same as each speaking unit's number after setting the units' ID. There are only 127 presets, and the 128th preset is used for panorama view.

8.3 PELCO-P Camera Control Protocol Format and Description

Communication Protocol: 9600, N, 8, 1

Control Command: all the following codes are in Hex format;

PELCO-P command format:

Byte 1	Byte 2	Byte 3	Byte 4	Byte 5	Byte 6	Byte 7	Byte 8
A0H	Address Code	Command Code 1	Command Code 2	Data Code 1	Data Code 2	AFH	Check Code

Description:

- ◆ Address Code is the camera's logic address number, which is fixed to be: 01H;
- ◆ Algorithm: Check Code = Byte 1 XOR Byte 2 XOR Byte 3 XOR Byte 4 XOR Byte 5 XOR Byte 6 XOR Byte 7. (Byte 1 to Byte 7 XOR);

Codes to configure the camera presets:

Byte 1	Byte 2	Byte 3	Byte 4	Byte 5	Byte 6	Byte 7	Byte 8
A0H	01H	00H	03H	00H	Preset point number	AFH	Check Code

Codes to call the camera presets:

Byte 1	Byte 2	Byte 3	Byte 4	Byte 5	Byte 6	Byte 7	Byte 8
A0H	01H	00H	07H	00H	Preset Point Number	AFH	Check Code

The preset number in the above table is the same as each speaking unit's number after setting the units' ID. There are only 127 presets, and the 128th preset is used for panorama view.

8.4 VISCA Camera Control Protocol Format and Description

Communication Protocol: 9600, N, 8, 1

Control Command: all the following codes are in Hex format;

Description:

- ◆ Address Code is the camera's logic address number, which is fixed to be: 01H;

Codes to configure the camera presets:

Inquiry	Packet Inq	Packet Reply	Description
CAM_ZoomPosInq	8x 09 04 47 FF	Y0 50 0Z 0Z 0Z 0Z FF	ZZZZ:zoom data.
Pan-tiltPosInq	8x 09 06 12 FF	Y0 50 0W 0W 0W 0W 0Z 0Z 0Z 0Z FF	8x:81; WWWW:pan; ZZZZ:tilt.

Codes to call the camera presets:

Command	VISCA Packet	Comments
CAM_Zoom	8x 01 04 47 0Z 0Z 0Z 0Z FF	8x:81; ZZZZ:zoom data.
Pan-tiltDrive	8x 01 06 02 VV WW 0Y 0Y 0Y 0Y 0Z 0Z 0Z 0Z FF	8x:81; YYYY:pan position data; ZZZZ:tilt position data.

When using VISCA camera protocol, the conference system mainframe stores one absolute

address for each unit, which can directly call camera's position. Support 127 units presets and 1 panorama view preset.

8.5 High Definition Camera CR-V1013 Settings

8.5.1 CR-V1013 Settings

When there are multiple CR-V1013 cascading with each other, VISCA protocol is recommended.

At the same time, the A.Fixed item needs to be set as "OFF" with the remote to make sure that where are cameras cascading, the cameras addresses can be broadcasted and allocated.

The detailed steps are as following:

Step One:

Use the camera remote to enter the camera's settings menu:

MENU

Exposure
Image
Noise Reduction
▶ Setup
Restore Default

Step Two:

Change the Setup item's parameters to the following:

SETUP

Language	EN
Protocol	VISCA
V.Addr	1
A.Fixed	off
Baudrate	9600

Step Three:

Save the settings and exit.

8.5.2 CR-V1013 camera VISCA Protocol Connection

8.5.2.1 CR-V1013 RS-232 Interface Pins

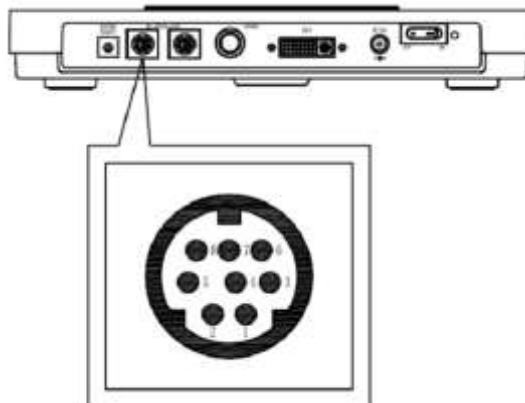

8.5.2.2 CR-V1013 VISCA Protocol Connection

Camera #1			Camera #2			Camera #3	
IN	OUT		IN	OUT		IN	OUT
1.DTR	1.DTR		1.DTR	1.DTR		1.DTR	1.DTR
2.DSR	2.DSR		2.DSR	2.DSR		2.DSR	2.DSR
3.TXR	3.TXR	↔	3.TXR	3.TXR	↔	3.TXR	3.TXR
4.GND	4.GND		4.GND	4.GND		4.GND	4.GND
5.RXD	5.RXD		5.RXD	5.RXD		5.RXD	5.RXD
6.GND	6.GND	↔	6.GND	6.GND	↔	6.GND	6.GND
7.IR	7.IR		7.IR	7.IR		7.IR	7.IR
8.NC	8.NC		8.NC	8.NC		8.NC	8.NC

8.5.3 Conference System Mainframe, Matrix Switcher, Camera Connection

DVI Matrix Switcher		Conference System Mainframe		Camera #1(CR-V1013)
DB9 Female Socket		DB9 Female Socket		Mini DIN Female Socket (RS232-IN)
1.NC		1.NC		1.DTR
2.TXD		2.RXD		2.DSR
3.RXD		3.TXD	↔	3.TXR
4.NC	←	4.NC		4.GND
5.GND		5.GND	↔	5.RXD
6.NC	—	6.NC		6.GND
7.NC		7.NC		7.IR
8.NC		8.NC		8.NC
9.NC		9.NC		

CREATOR CORPORATION (CHINA)
Copyright by CREATOR

Last Revision: 06/2015

