

Pioneer

REMIX STATION

RMX-500

<http://pioneerdj.com/support/>

The Pioneer DJ support site shown above offers FAQs, information on software and various other types of information and services to allow you to use your product in greater comfort.

Operating Instructions



Contents

How to read this manual

- Thank you for buying this Pioneer product.
Be sure to read this booklet and the "Operating Instructions (Basic Edition)" included with this unit. Both include important information that should be fully understood before using this product.
- In this manual, names of channels and buttons indicated on the product, names of menus in the software, etc., are indicated within square brackets ([]). (e.g. **[MASTER]** channel, **[ON/OFF]**, **[File]** menu)

01 Before start

Features	3
Installing the software.....	3
Connecting the input/output terminals.....	6
Starting up and preparing this unit.....	9
Connecting this unit and computer.....	9
About the setting utility software	9

02 Operation

Setting the BPM.....	10
RHYTHM FX section	11
SCENE FX section.....	12
RELEASE FX section.....	13
Switching the audio signal path.....	13
Customizing the effect parameters.....	13
Using the update function	13
Using RMX-500 Plug-in	13

03 Additional information

Troubleshooting.....	15
About trademarks and registered trademarks	15
Cautions on copyrights	15
General Disclaimer.....	15

Before start

Features

This unit is a remix station for DJs consisting of three effect sections. The [PRESSURE] controllers newly adopted for the RHYTHM FX and SCENE FX sections allow effects to be adjusted not only by turning the controller as before, but also according to the strength with which the controller is pressed in.

Furthermore, the internal effect type can be switched to achieve highly individualistic DJ remixing performances with more intuitive operation than ever before.

The "RMX-500 Plug-in" Plug-in software allows this unit to be operated on music creation applications. In addition, by connecting this unit to a computer, this unit can be used as a controller to create music with the same feeling as when conducting a DJ performance.

RHYTHM FX

New rhythms can be created by cutting up the currently playing track or adding internal sound sources.

Effects and internal drum sound sources can be used for loop playback with a variety of rhythms.

SCENE FX

The currently playing track can be emphasized or breaks can be created at any position to produce new developments for tracks.

Effects and echoes can be combined to achieve unique renderings.

RELEASE FX

Effect sounds can be blended smoothly with the currently playing track.

QUANTIZE

The beat positions of tracks are analyzed in real time and the effects and the timing for producing the sound are adjusted automatically. The sound is played in tempo with the track, even when buttons are operated roughly.

RMX-500 Plug-in

A VST/AU/RTAS Plug-in letting you launch the functions of this unit on a computer is provided. With it, the RMX-500 can be used as a controller.

SOUND CARD

This unit is equipped with "sound card/USB audio interface".

Installing the software

Software end user license agreement

This Software End User License Agreement ("Agreement") is between you (both the individual installing the Program and any single legal entity for which the individual is acting) ("You" or "Your") and PIONEER CORPORATION ("Pioneer").

TAKING ANY STEP TO SET UP OR INSTALL THE PROGRAM MEANS THAT YOU ACCEPT ALL OF THE TERMS OF THIS LICENSE AGREEMENT. PERMISSION TO DOWNLOAD AND/OR USE THE PROGRAM IS EXPRESSLY CONDITIONED ON YOUR FOLLOWING THESE TERMS. WRITTEN OR ELECTRONIC APPROVAL IS NOT REQUIRED TO MAKE THIS AGREEMENT VALID AND ENFORCEABLE. IF YOU DO NOT AGREE TO ALL OF THE TERMS OF THIS AGREEMENT, YOU ARE NOT AUTHORIZED TO USE THE PROGRAM AND MUST STOP INSTALLING IT OR UNINSTALL IT, AS APPLICABLE.

1 DEFINITIONS

- 1 "Documentation" means written documentation, specifications and help content made generally available by Pioneer to aid in installing and using the Program.
- 2 "Program" means all or any part of Pioneer's software licensed to You by Pioneer under this Agreement.

2 PROGRAM LICENSE

- 1 Limited License. Subject to this Agreement's restrictions, Pioneer grants to You a limited, non-exclusive, non-transferable, license (without the right to sublicense):
 - a To install a single copy of the Program in Your computer or mobile device, to use the Program only for Your personal purpose complying with this Agreement and the Documentation ("Authorized Use");
 - b To use the Documentation in support of Your Authorized Use; and
 - c To make one copy of the Program solely for backup purposes, provided that all titles and trademark, copyright and restricted rights notices are reproduced on the copy.
- 2 Restrictions. You will not copy or use the Program or Documentation except as expressly permitted by this Agreement. You will not transfer, sublicense, rent, lease or lend the Program, or use it for third-party training, commercial time-sharing or service bureau use. You will not Yourself or through any third party modify, reverse engineer, disassemble or decompile the Program, except to the extent expressly permitted by applicable law, and then only after You have notified Pioneer in writing of Your intended activities.
- 3 Ownership. Pioneer or its licensor retains all right, title and interest in and to all patent, copyright, trademark, trade secret and other intellectual property rights in the Program and Documentation, and any derivative works thereof. You do not acquire any other rights, express or implied, beyond the limited license set forth in this Agreement.
- 4 No Support. Pioneer has no obligation to provide support, maintenance, upgrades, modifications or new releases for the Program or Documentation under this Agreement.

3 WARRANTY DISCLAIMER

THE PROGRAM AND DOCUMENTATION ARE PROVIDED "AS IS" WITHOUT ANY REPRESENTATIONS OR WARRANTIES, AND YOU AGREE TO USE THEM AT YOUR SOLE RISK. TO THE FULLEST EXTENT PERMISSIBLE BY LAW, PIONEER EXPRESSLY DISCLAIMS ALL WARRANTIES OF ANY KIND WITH RESPECT TO THE PROGRAM AND DOCUMENTATION, WHETHER EXPRESS, IMPLIED, STATUTORY, OR ARISING OUT OF COURSE OF PERFORMANCE, COURSE OF DEALING OR USAGE OF TRADE, INCLUDING ANY WARRANTIES OF MERCHANTABILITY, FITNESS FOR A PARTICULAR PURPOSE, SATISFACTORY QUALITY, ACCURACY, TITLE OR NON-INFRINGEMENT.

4 EXPORT CONTROL AND COMPLIANCE WITH LAWS AND REGULATIONS

You may not use or otherwise export or re-export the Program except as authorized by United States law and the laws of the jurisdiction in which the Program was obtained. In particular, but without limitation, the Program may not be exported or re-exported (a) into any U.S.-embargoed countries or (b) to anyone on the U.S. Treasury Department's Specially Designated Nationals List or the U.S. Department of Commerce Denied Persons List or Entity List. By using the Program, you represent and warrant that you are not located in any such country or on any such list. You also agree that you will not use the Program for any purposes prohibited by United States law, including, without limitation, the development, design, manufacture, or production of nuclear, missile, or chemical or biological weapons.

5 U.S. GOVERNMENT RESTRICTED RIGHTS

The Program and Documentations are "commercial computer software" and "commercial computer software documentation" as those terms are defined in 48 C.F.R. §252.227-7014 (a) (1) (2007) and 252.227-7014

(a) (5) (2007). The U.S. Government's rights with respect to the Program and Documentations are limited by this license pursuant to 48 C.F.R. § 12.212 (Computer software) (1995) and 48 C.F.R. §12.211 (Technical data) (1995) and/or 48 C.F.R. §227.7202-3, as applicable. As such, the Program and Documentations are being licensed to the U.S. Government end users: (a) only as "commercial items" as that term is defined in 48 C.F.R. §2.101 generally and as incorporated in DFAR 212.102; and (b) with only those limited rights as are granted to the public pursuant to this license. Under no circumstance will the U.S. Government or its end users be granted any greater rights than we grant to other users, as provided for in this license. Manufacturer is Pioneer Corporation, 1-1 Shin-Ogura, Saiwai-ku, Kawasaki-shi, Kanagawa-Ken, 212-0031 Japan

6 DAMAGES AND REMEDIES FOR BREACH

You agree that any breach of this Agreement's restrictions would cause Pioneer irreparable harm for which money damages alone would be inadequate. In addition to damages and any other remedies to which Pioneer may be entitled, You agree that Pioneer may seek injunctive relief to prevent the actual, threatened or continued breach of this Agreement.

7 TERMINATION

Pioneer may terminate this Agreement at any time upon Your breach of any provision. If this Agreement is terminated, You will stop using the Program, permanently delete it from your computer or mobile device where it resides, and destroy all copies of the Program and Documentation in Your possession, confirming to Pioneer in writing that You have done so. Sections 2.2, 2.3, 2.4, 3, 4, 5, 6, 7 and 8 will continue in effect after this Agreement's termination.

8 GENERAL TERMS

- 1** Limitation of Liability. In no event will Pioneer or its subsidiaries be liable in connection with this Agreement or its subject matter, under any theory of liability, for any indirect, incidental, special, consequential or punitive damages, or damages for lost profits, revenue, business, savings, data, use, or cost of substitute procurement, even if advised of the possibility of such damages or if such damages are foreseeable. In no event will Pioneer's liability for all damages exceed the amounts actually paid by You to Pioneer or its subsidiaries for the Program. The parties acknowledge that the liability limits and risk allocation in this Agreement are reflected in the Program price and are essential elements of the bargain between the parties, without which Pioneer would not have provided the Program or entered into this Agreement.
- 2** The limitations or exclusions of warranties and liability contained in this Agreement do not affect or prejudice Your statutory rights as consumer and shall apply to You only to the extent such limitations or exclusions are permitted under the laws of the jurisdiction where You are located.
- 3** Severability and Waiver. If any provision of this Agreement is held to be illegal, invalid or otherwise unenforceable, that provision will be enforced to the extent possible or, if incapable of enforcement, deemed to be severed and deleted from this Agreement, and the remainder will continue in full force and effect. The waiver by either party of any default or breach of this Agreement will not waive any other or subsequent default or breach.
- 4** No Assignment. You may not assign, sell, transfer, delegate or otherwise dispose of this Agreement or any rights or obligations under it, whether voluntarily or involuntarily, by operation of law or otherwise, without Pioneer's prior written consent. Any purported assignment, transfer or delegation by You will be null and void. Subject to the foregoing, this Agreement will be binding upon and will inure to the benefit of the parties and their respective successors and assigns.
- 5** Entire Agreement. This Agreement constitutes the entire agreement between the parties and supersedes all prior or contemporaneous agreements or representations, whether written or oral, concerning its subject matter. This Agreement may not be modified or amended without Pioneer's prior and express written consent, and no other act, document, usage or custom will be deemed to amend or modify this Agreement.
- 6** You agree that this Agreement shall be governed and construed by and under the laws of Japan.

Installing the driver software

This driver software is a proprietary program for inputting and outputting audio signals from the computer. To use this unit connected to a computer on which a Windows or Mac OS is installed, install the driver software on the computer beforehand.

Checking the latest information on the driver software

For information on the latest version of the driver software, see the Pioneer DJ support site below.
<http://pioneerdj.com/support/>

❖ Cautions on Installation

- Before installing the driver software, be sure to turn off the power of this unit and disconnect the USB cable from both this unit and your computer.
- If you connect this unit to your computer without installing the driver software first, an error may occur on your computer depending on the system environment.
- If you have discontinued the installation process in progress, step through the installation process again from the beginning according to the following procedure.
- Read *Software end user license agreement* carefully before installing this unit's proprietary driver software.
- Before installing the driver software, terminate all other programs running on your computer.
- The driver software is compatible with the following OSs.

Supported operating systems	
Mac OS X 10.6 / 10.7 / 10.8	✓
Windows® 8/Windows® 8 Pro	32-bit version ✓
	64-bit version ✓
Windows® 7 Home Premium/Professional/Ultimate	32-bit version ✓
	64-bit version ✓
Windows Vista® Home Basic/Home Premium/Business/Ultimate	32-bit version ✓
	64-bit version ✓

- Operation is not guaranteed when multiple units of the RMX-500 are connected to a single computer.

❖ Installation Procedure (Windows)

Read *Cautions on Installation* carefully before installing the driver software.

- To install or uninstall the driver software, you need to be authorized by the administrator of your computer. Log on as the administrator of your computer before proceeding with the installation.

1 Click [Software Download] under [RMX-500] on the Pioneer DJ support site.

2 Click [Driver Software].

3 From the download page, download the driver software for Windows (RMX-500_X.XXX.exe).

4 Double-click the downloaded file.

The driver installation screen appears.

5 When the language selection screen appears, select [English] and click [OK].

- You can select the one you desire from multiple languages as long as the language is supported by the system environment of your computer.

6 Carefully read the *Software end user license agreement* and if you consent to the provisions, put a check mark in [I agree.] and click [OK].

If you do not consent to the provisions of the *Software end user license agreement*, click [Cancel] and stop installation.

7 Proceed with installation according to the instructions on the screen.

If [Windows Security] appears on the screen while the installation is in progress, click [Install this driver software anyway] and continue with the installation.

- When the installation program is completed, a completion message appears.

❖ Installation procedure (Mac OS X)

Read *Cautions on Installation* carefully before installing the driver software.

- To install or uninstall the driver software, you need to be authorized by the administrator of your computer. Have the name and password of the administrator of your computer ready in advance.

1 Click [Software Download] under [RMX-500] on the Pioneer DJ support site.

2 Click [Driver Software].

3 From the download page, download the driver software for Mac OS (RMX-500_M_X.X.X.dmg).

4 Double-click the downloaded file.

The [RMX-500_AudioDriver] menu screen appears.

5 Double-click [RMX-500_AudioDriver.pkg].

The driver installation screen appears.

6 Check the details on the screen and click [Continue Anyway].

7 When the end user license agreement appears, read *Software end user license agreement* carefully, then click [Continue Anyway].

8 If you consent to the provisions of the *Software end user license agreement*, click [Agree].

If you do not consent to the provisions of the *Software end user license agreement*, click [Disagree] and stop installation.

9 Proceed with installation according to the instructions on the screen.

- Click [Cancel] to cancel installation after it has started.

Installing RMX-500 Plug-in

This software is a plug-in for enabling functions of the RMX-500 to be used on music creation applications. In order to use this software, the plug-in must be running on a host application that supports the plug-in (VST, Audio Units or RTAS®).

- A computer equipped with an Intel® Core™ 1.4 GHz or greater CPU is recommended for using this software.
- Use a computer on which the host application operates stably.
- For the operating requirements of the host application, see your host application's operating instructions or website.

Checking the latest information about the RMX-500 Plug-in

For up-to-date RMX-500 Plug-in information, see the Pioneer DJ support site below.

<http://pioneerdj.com/support/>

❖ Cautions on Installation

- If installation of this software has been interrupted, start installation over from the beginning following the procedure below.
- Read *Software end user license agreement* carefully before installing this software.
- Quit any other programs that may be running on the computer before installing this software.
- This software is supported on the operating systems below.

Supported operating systems

Windows	Windows® 8/Windows® 8 Pro	32-bit version	✓
		64-bit version	✓
	Windows® 7 Home Premium/Professional/Ultimate (SP1 or later)	32-bit version	✓
		64-bit version	✓
Intel Mac	Windows Vista® Home Basic/Home Premium/Business/Ultimate (SP2 or later)	32-bit version	✓
		64-bit version	✓
	Mac OS X 10.8	32-bit version	✓
		64-bit version	✓
Intel Mac	Mac OS X 10.7	32-bit version	✓
		64-bit version	✓
	Mac OS X 10.6	32-bit version	✓
		64-bit version	✓

- Operation is not guaranteed when multiple units of the RMX-500 are connected to a single computer.

❖ About the installation procedure (Windows and Mac OS X)

Read *Cautions on Installation* carefully before installing this software.

- Authorization of the computer's administrator is required to install and uninstall this software.
Log on as the user which was set as the computer's administrator before installing.

1 Click [Software Download] under [RMX-500] on the Pioneer DJ support site.

2 Click [RMX-500 Plug-in].

3 Download RMX-500 Plug-in for Windows, or RMX-500 Plug-in for Mac OS from the download page.

4 Double-click the downloaded file.

The RMX-500 Plug-in installation screen appears.

5 When the language selection screen appears, select [English] and click [OK].

- You can select the one you desire from multiple languages as long as the language is supported by the system environment of your computer.

6 When the license agreement screen appears, read the *Software end user license agreement* carefully. If you agree to the *Software end user license agreement*, click [Agree].

- If you do not consent to the provisions of the *Software end user license agreement*, click [Disagree] and stop installation.

7 Follow the instructions on the screen to install this software.

- Click [Cancel] to cancel installation after it has started.
- For Windows, specify the folder containing the host application's VST plug-in as the location for installing the VST plug-in.
- If the plug-in is installed according to default settings, files are placed in the following folders.
 - Mac OS X
 - VST:/Library/Audio/Plug-Ins/VST/
 - AU:/Library/Audio/Plug-Ins/Components/
 - RTAS:/Library/Application Support/Digidesign/Plug-Ins/
 - 32-bit version of Windows
 - VST:\Program Files\Pioneer\RMX-500 Plug-in
 - RTAS:\Program Files\Common Files\Digidesign\DAE\Plug-Ins
 - 64-bit version of Windows
 - VST:\Program Files (x86)\Pioneer\RMX-500 Plug-in
 - RTAS:\Program Files (x86)\Common Files\Digidesign\DAE\Plug-Ins

Connecting the input/output terminals

Be sure to turn off the power and unplug the power cord from the power outlet whenever making or changing connections.

Connect the power cord after all the connections between devices have been completed.

Be sure to use the power cord, AC adapter and USB cable included with this product.

Refer to the operating instructions for the component to be connected.

Power to this unit is supplied by the AC adapter or by USB bus power.

This unit can be used by connecting it to a computer using a USB cable, even without connecting the AC adapter.

- Connect this unit and the computer directly using the included USB cable.
- Do not connect via a USB hub.
- Connect the computer to which this unit is to be connected to an AC power supply.
- The brightness of the buttons that light is dimmer when using USB bus power.
- When running on USB bus power, the unit may not operate in the following cases:
 - When the power supply capacity of the computer's USB port is insufficient.
 - When other USB devices are connected to the computer.
 - When headphones with an impedance of less than $32\ \Omega$ are connected.
 - When a monaural jack is connected to the [PHONES] terminal.
- This unit may restart if the AC adapter or USB cable is disconnected during operation.

Example of connections

❖ To connect to the DJ mixer's [MASTER OUT] terminals

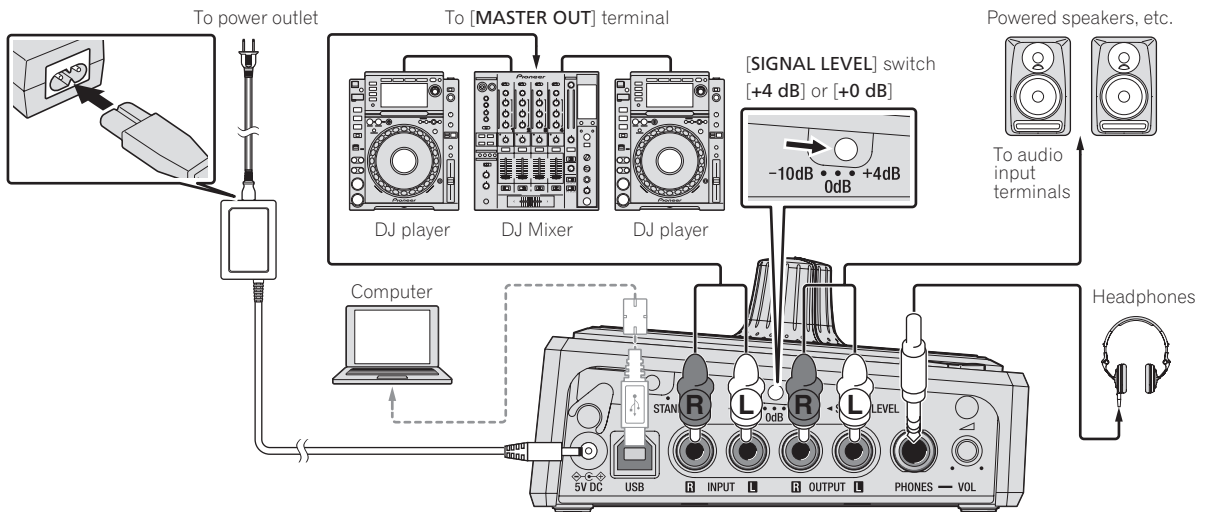

❖ To connect to the DJ controller's [MASTER OUT] terminals

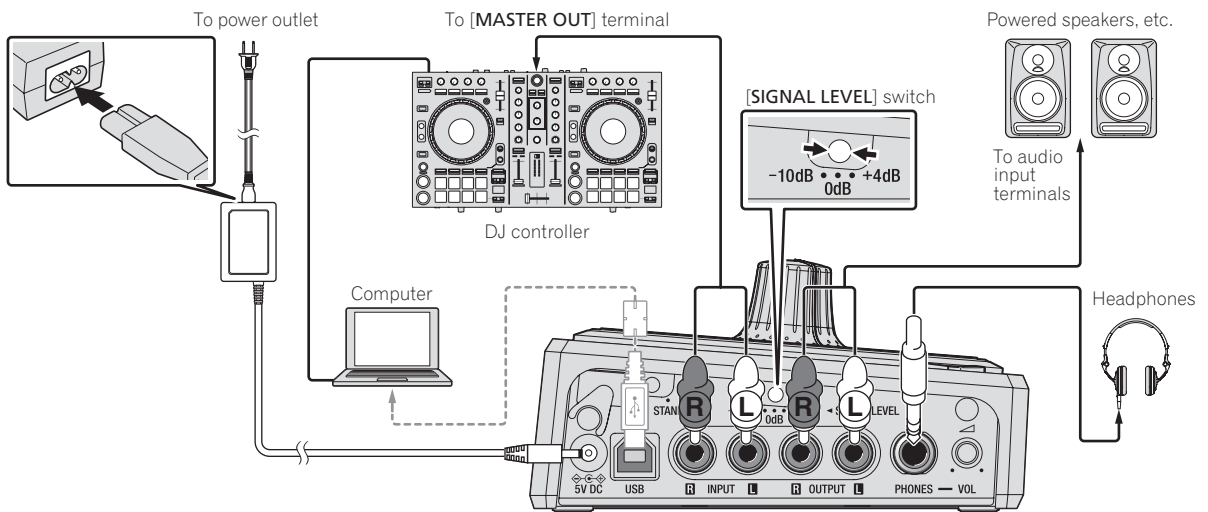

❖ **To connect to the [SEND] and [RETURN] terminals on the DJ mixer**

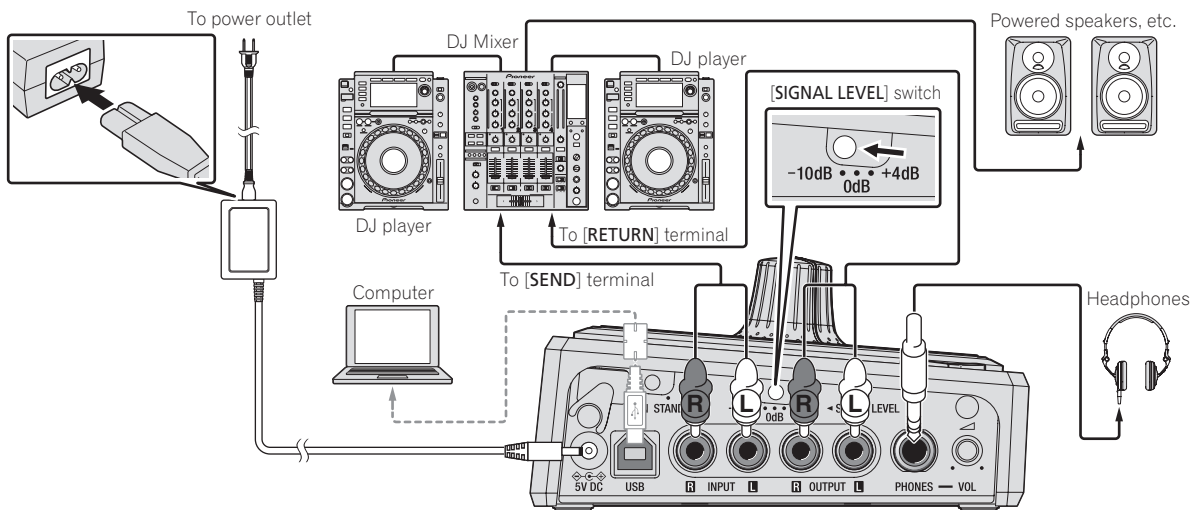

❖ **When this unit is connected to your computer and you are using it as a sound card/USB audio interface**

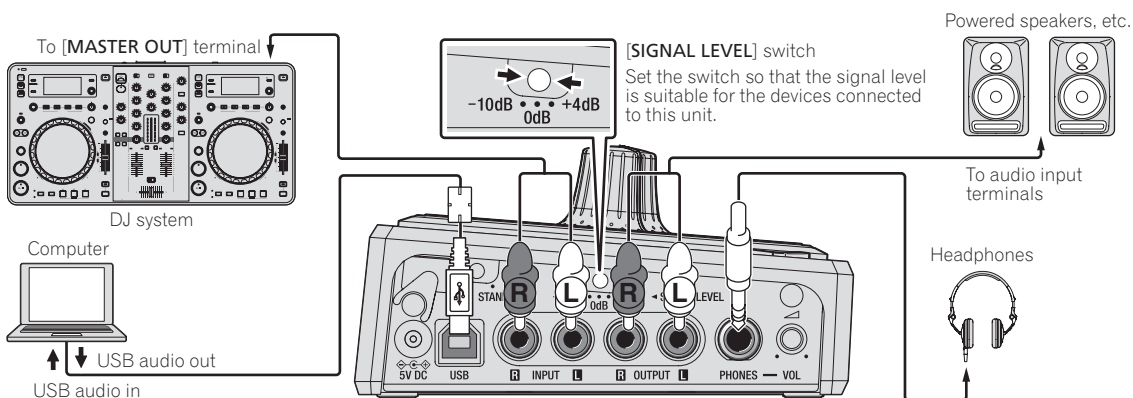

❖ **When this unit is connected to your computer with the RMX-500 Plug-in application installed and you are using it as a plug-in controller**

When this unit detects the RMX-500 Plug-in application, plug-in controller mode is operated. Effects processing is not carried out on this product in such cases.

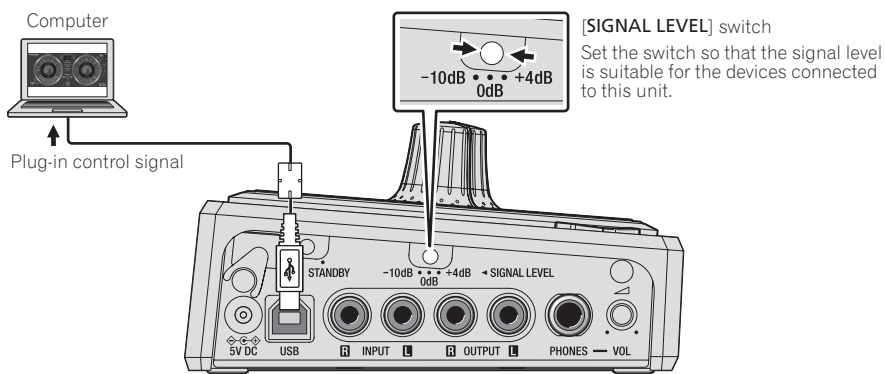

❖ **When this unit is connected to your computer with the RMX-500 Plug-in application installed and you are using it as a plug-in controller and sound card/USB audio interface**

When this unit detects the RMX-500 Plug-in application, plug-in controller mode is operated. Effects processing is not carried out on this product in such cases.

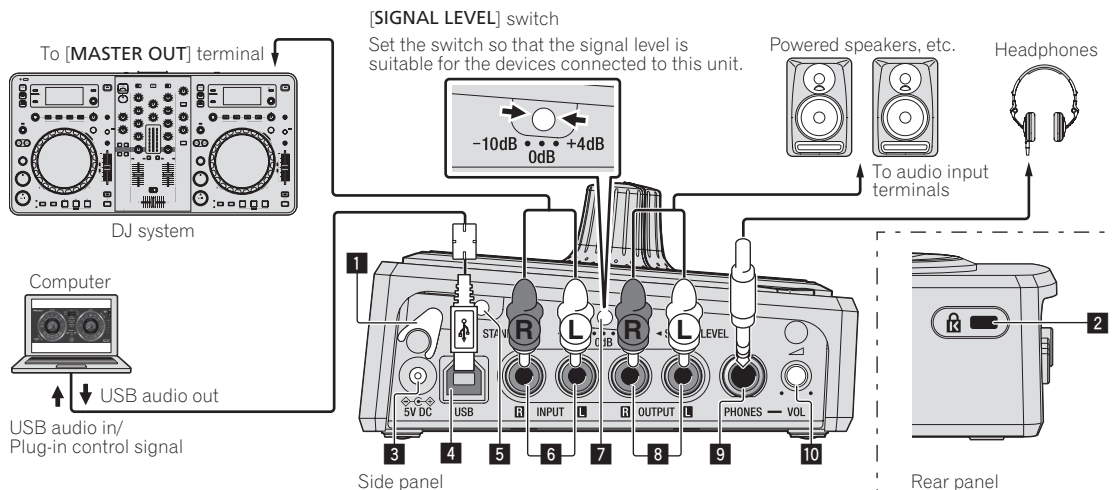

1 Cord hook

Hook the AC adapters' power cord here.

- The sound will be interrupted if the AC adapter's power cord is disconnected from the unit during playback.

Using the cord hook

Hook the AC adapter's power cord onto the cord hook to fasten it in place. This prevents the power cord from being accidentally pulled, causing the plug to get disconnected from the terminal.

- As shown on the diagram below, extend the tip of the power cord to side of this unit and hook the power cord onto the cord hook.

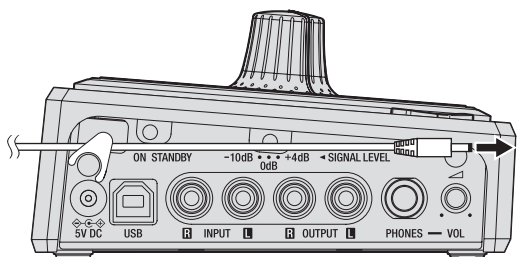

- Turn the tip of the power cord so that it is facing towards you, then turn it back to create a ring as shown in the diagram and insert it into the [5V DC] terminal of this unit.

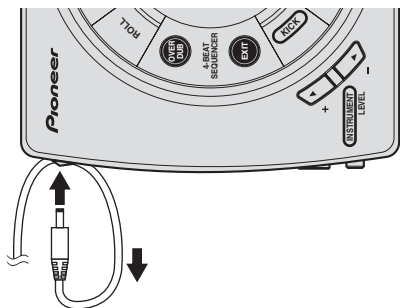

2 Kensington security slot

3 5V DC terminal

Connect the included AC adapter's DC plug here. Wait until all connections of the equipment are completed before connecting the power cord.
Be sure to use the power cord and AC adapter included with this product.

4 USB port

Connect to a computer.

- Connect this unit and the computer directly using the included USB cable.
- A USB hub cannot be used.

5 ON, STANDBY switch

This switches this unit's power between on and standby.

6 INPUT terminals

Connect to the external output terminals of a DJ mixer, DJ controller, DJ player, etc.

7 SIGNAL LEVEL switch

This switches this unit's input/output gain.

Set as shown below, according to the devices connected to this unit.

- [+4 dB]: Select this when connecting to a DJ mixer's [MASTER OUT] terminals.
- [+0 dB]: Select this when connected to the [MASTER OUT] terminals of a DJ mixer or DJ controller.
- [-10 dB]: Select this when connected to a DJ mixer's [SEND] and [RETURN] terminals.

8 OUTPUT terminals

Connect these to the external input terminals of powered speakers, a DJ mixer, etc.

CAUTION

Interconnect the equipment in such a way that the flow of the audio signals does not loop. If looped connections are made, the circuitry could produce oscillations that may damage the speakers, etc.

Examples of looped connections to be avoided

- Connecting a DJ mixer's output to this unit's input terminals then inputting this unit's output to the same DJ mixer's input terminals.
- Connecting the output from a DJ mixer's [SEND] terminals to this unit's input terminals then inputting this unit's output to input terminals other than the [RETURN] terminals on the same DJ mixer.

9 PHONES terminals

Connect headphones here.

- Connect headphones with an impedance of 32 Ω or more. Headphones with an impedance of less than 32 Ω are not supported.

10 HEADPHONES VOL control

Adjusts the audio level output from the [PHONES] terminal.

Starting up and preparing this unit

- 1 **Connect following the instructions at *Connecting the input/output terminals* on page 6.**
- 2 **Slide the [ON, STANDBY] switch on the rear panel of this unit to the [ON] position.**

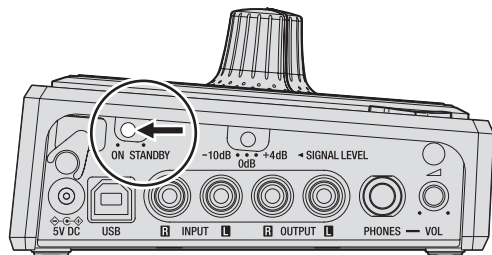

- 3 **Check the audio level of the sound that is being input and output using the peak level indicators.**

The brightness and color of the peak level indicators change according to the audio level of the sound that is being input and output.

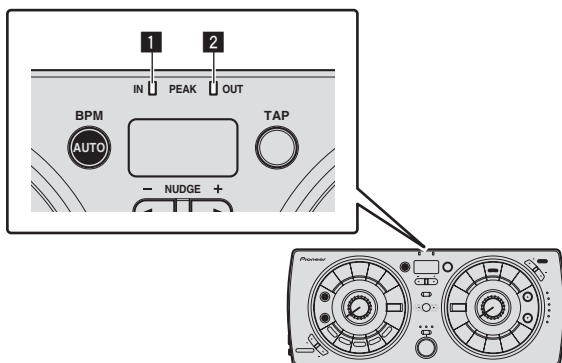

- 1 **INPUT** peak level indicator
 - 2 **OUTPUT** peak level indicator
- Green: Permissible level
Orange: Appropriate level
Red: Excessive level

- If the peak level indicator lights red, the audio level of the input sound is too high. Switch the [SIGNAL LEVEL] switch or lower the output level of the connected device.
- This unit does not have a function for adjusting the input/output audio level. To adjust the input/output audio level, operate the devices connected to this unit.

Connecting this unit and computer

- 1 **Connect this unit to your computer via a USB cable.**

This unit functions as an audio device conforming to the ASIO standards.

- This operation does not work with computers that do not support USB 2.0.
- The computer's recommended operating environment depends on the DJ application. Be sure to check the recommended operating environment for the DJ application you are using.
- When another USB audio device is connected to the computer at the same time, it may not operate or be recognized normally. We recommend only connecting the computer and this unit.
- When connecting the computer and this unit, we recommend connecting directly to this unit's USB port.

- 2 **Turn the [ON, STANDBY] switch on.**

Turn on the power of this unit.

About the setting utility software

The setting utility can be used to make the checks and settings described below.

- Setting the headphone output source of this unit
- Setting the link of master volume and the [HEADPHONES VOL] control
- Setting the MIDI output ON/OFF and MIDI channel of this unit
- Adjusting the buffer size (when using Windows ASIO)
- Checking the version of the driver software

Displaying the setting utility

For Windows 8

Click [Start] menu > [RMX-500 Settings Utility].

For versions of Windows other than Windows 8

Click [Start] menu > [All Programs] > [Pioneer] > [RMX-500] > [RMX-500 Settings Utility].

For Mac OS X

Click [Macintosh HD] icon > [Application] > [Pioneer] > [RMX-500] > [RMX-500 Settings Utility].

Setting the headphone output source of this unit

Display the setting utility before starting.

Click the [HEADPHONES] tab.

When using this unit as an audio device, set either the audio data output from this unit to the computer, or the audio data input from the computer to this unit as the audio output from [PHONES] terminal.

Factory default settings are audio data input from the computer to this unit.

Setting the link of master volume and the [HEADPHONES VOL] control

Display the setting utility before starting.

Click the [MASTER] tab.

Set whether to link the [HEADPHONES VOL] control to the master volume or not.

Factory default setting is not to link them.

Setting the MIDI output ON/OFF and MIDI channel of this unit

Display the setting utility before starting.

Click the [MIDI] tab.

- **MIDI CHANNEL**
Sets the MIDI channel for this unit.
- **MIDI OUTPUT**
Sets whether MIDI data is output from this unit to the computer or not. Factory default setting is not to output MIDI data.

Adjusting the buffer size (when using Windows ASIO)

If an application using this unit as the default audio device is running, quit that application before adjusting the buffer size.

Display the setting utility before starting.

Click the [ASIO] tab.

- If the buffer size is made large, drops in audio data (breaks in the sound) occur less easily, but the time lag due to the delay in the transfer of the audio data (latency) increases.

Checking the version of the driver software

Display the setting utility before starting.

Click the [About] tab.

❖ Checking the latest information on the driver software

For information on the latest version of the driver software, see the Pioneer DJ support site below.

<http://pioneerdj.com/support/>

- Operation cannot be guaranteed when multiple units of this mixer are connected to a single computer.

Operation

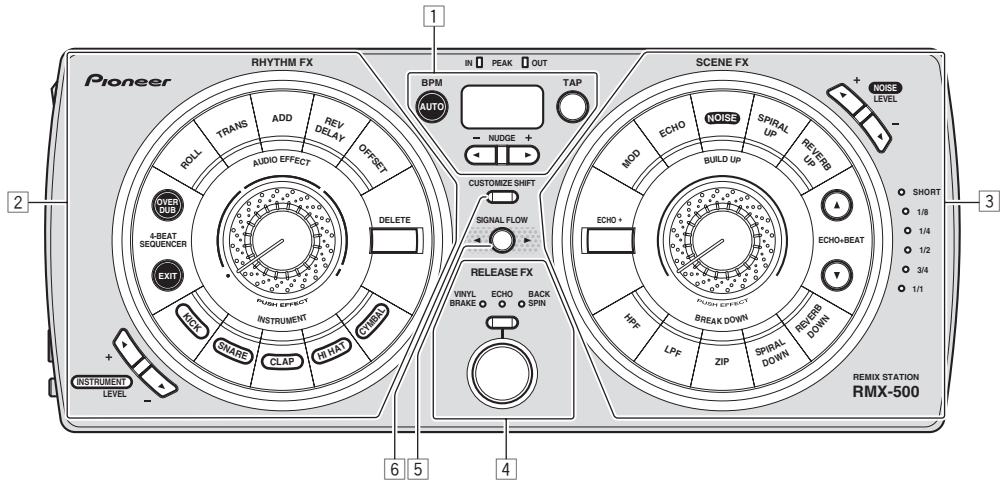

- 1 **Setting the BPM (page 10)**
- 2 **RHYTHM FX section (page 11)**
- 3 **SCENE FX section (page 12)**
- 4 **RELEASE FX section (page 13)**
- 5 **Switching the audio signal path (page 13)**
- 6 **Customizing the effect parameters (page 13)**

Setting the BPM

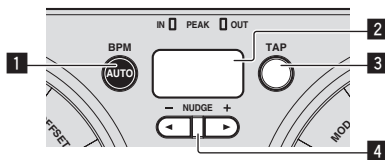

1 AUTO button

Switches the BPM measurement mode.

- **[AUTO]**: The BPM is measured automatically from the audio signal that is being input. The **[AUTO]** mode is set when this unit's power is turned on.
- **[TAP]**: The BPM is input manually by tapping the **[TAP]** button with a finger.
- The **[AUTO]** BPM measurement range is BPM = 70 to 180. With some tracks it may not be possible to measure the BPM correctly. If the BPM cannot be measured, the BPM value on the display flashes. In such cases, use the **[TAP]** button to input the BPM manually.

2 BPM display

When the BPM measurement mode is set to auto, this displays the automatically detected BPM value. If the value cannot be detected, the previously detected BPM value flashes.

When the BPM measurement mode is set to manual, this displays the manually input BPM value.

3 TAP button

Tap the button with a finger to input the BPM manually.

4 NUDGE (+, -) button

These fine-adjust the cycle and the timing for producing the sound of internal sound sources, etc.

Inputting the BPM manually

Tap the **[TAP]** button at least 2 times in rhythm with the beat (in quarter notes) of the sound being played.

The interval at which the **[TAP]** button was tapped is set as the BPM.

- The BPM can be set manually in units of 1 by pressing a **[NUDGE (+, -)]** button while pressing the **[TAP]** button.
- The BPM can be set manually in units of 0.1 by pressing the **[AUTO]** button while pressing the **[TAP]** button, then pressing a **[NUDGE (+, -)]** button while pressing the two buttons.

RHYTHM FX section

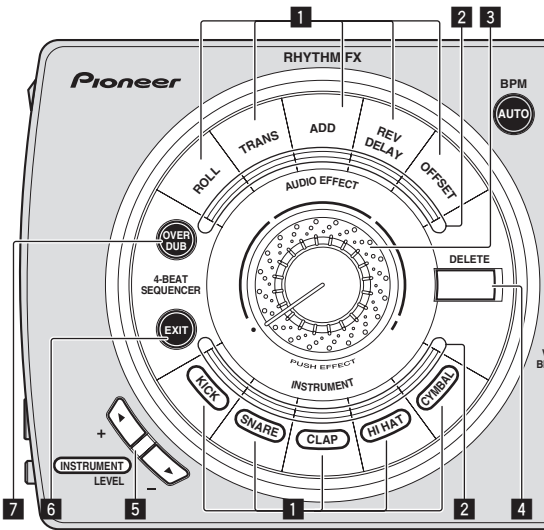

1 RHYTHM FX buttons

These turn the RHYTHM FX effects on and off.

2 RHYTHM FX indicator

This flashes when an effect is on.

3 RHYTHM FX control

This adjusts the selected RHYTHM FX effect.

4 DELETE button

This button can be used to delete the operations of the [RHYTHM FX] buttons that were recorded using the 4-BEAT SEQUENCER function, one button at a time.

5 Internal sound source volume adjustment buttons

These adjust the volume of the internal sound sources.

6 EXIT button

This lights when the 4-BEAT SEQUENCER function is on. When the button is pressed, the 4-BEAT SEQUENCER function turns off.

7 OVERDUB button

The 4-BEAT SEQUENCER function turns on. The operations of the [RHYTHM FX] buttons are recorded and the sound is played in a loop.

Using the RHYTHM FX function

1 Press one of the [RHYTHM FX] buttons.

Select the RHYTHM FX effect type.

The button that was pressed flashes.

- Internal sound sources are preset at each of the [KICK], [SNARE], [CLAP], [HI HAT] and [CYMBAL] buttons.
- For details on the types of effects, see the Pioneer DJ support site below.
<http://pioneerdj.com/support/>

2 Turn the [RHYTHM FX] control.

The effect is applied to the sound.

- The strength of the effect increases when the control is turned clockwise. The strength of the effect is maximum when the control is turned fully clockwise.
- The strength of the effect decreases when the control is turned counterclockwise. When turned fully counterclockwise, the original sound is output, with no effect applied.

3 Press the [RHYTHM FX] control.

A sound processing or sound adding effect is applied, depending on the type of effect that is selected.

- The sound processing or sound adding effect changes according to the strength with which the control is pressed in.
- When the selected [RHYTHM FX] button is pressed again, the effect turns off.

Using the 4-BEAT SEQUENCER function

The order and timing at which the [RHYTHM FX] buttons are pressed are recorded and the sound is played in a loop.

1 Press the [OVERDUB] button.

When the [OVERDUB] button is pressed, the 4-BEAT SEQUENCER function turns on and the [OVERDUB] button flashes brightly.

While the [OVERDUB] button is flashing brightly, the operations of the [RHYTHM FX] buttons are recorded and loop playback continues.

When the [OVERDUB] button is pressed again, it starts flashing dimly and loop playback continues, but additional operations of the [RHYTHM FX] buttons are not recorded.

- When the 4-BEAT SEQUENCER function is on, RHYTHM FX effects are only applied while the corresponding [RHYTHM FX] button is being pressed.

2 While pressing the [DELETE] button, press the [RHYTHM FX] button whose recorded operation you want to delete.

When the [DELETE] button is pressed, the [RHYTHM FX] buttons whose operations are recorded light. When a lit button is pressed, the button turns off and the operation of that [RHYTHM FX] button which was recorded is deleted.

3 Press the [EXIT] button.

When the [EXIT] button is pressed, all the operations of the [RHYTHM FX] buttons that were recorded with the 4-BEAT SEQUENCER function are deleted. The 4-BEAT SEQUENCER function turns off and loop playback stops.

SCENE FX section

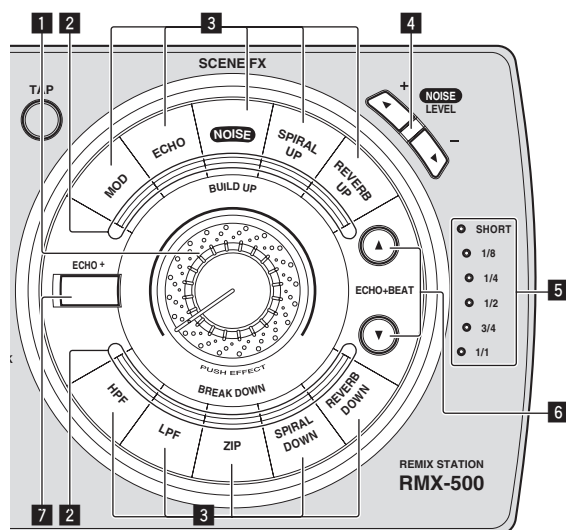

Using the ECHO + function

An [ECHO] effect can be applied over the SCENE FX effect and output.

1 Use the [BEAT (▲, ▼)] buttons to select the multiple for synchronizing the [ECHO] effect.

2 Press the [ECHO +] button.

The ECHO + function turns on.

The [ECHO] effect is applied over the selected effect and output.

- When the [ECHO +] button is pressed again, the ECHO + function turns off.

1 SCENE FX control

This adjusts the selected SCENE FX effect.

2 SCENE FX indicator

This flashes when an effect is on.

3 SCENE FX buttons

These turn the SCENE FX effects on and off.

4 NOISE volume adjustment buttons

These adjust the volume of the [NOISE] effect applied to the input sound or the output sound.

5 ECHO + beat select indicators

The indicator for the beat for which the ECHO + function synchronizes lights.

6 BEAT (▲, ▼) button

Selects the beat multiple for synchronizing the ECHO + function.

7 ECHO + button

This turns the ECHO + function on and off.

Using the SCENE FX function

1 Press one of the [SCENE FX] buttons.

Select the SCENE FX effect type.

The button that was pressed flashes.

- For details on the types of effects, see the Pioneer DJ support site below.
<http://pioneerdj.com/support/>

2 Turn the [SCENE FX] control.

The effect is applied to the sound.

- The strength of the effect increases when the control is turned clockwise. The strength of the effect is maximum when the control is turned fully clockwise.
- The strength of the effect decreases when the control is turned counterclockwise. When turned fully counterclockwise, the original sound is output, with no effect applied.

3 Press the [SCENE FX] control.

An additional effect is applied to the sound.

- The additional effect changes according to the strength with which the control is pressed in.
- When the selected [SCENE FX] button is pressed again, the effect turns off.

RELEASE FX section

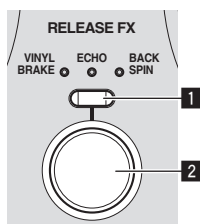

1 RELEASE FX type selection button

This switches the type of RELEASE FX effect.

2 RELEASE FX button

These turn the RELEASE FX effects on and off.

Using the RELEASE FX function

1 Press the [RELEASE FX] type selection button.

Select the RELEASE FX effect type.

- For details on the types of effects, see the Pioneer DJ support site below.
<http://pioneerdj.com/support/>

2 Press the [RELEASE FX] button.

This turns the effect on.

The effect is applied to the sound.

- When you release your finger from the button, the effect turns off. The RHYTHM FX and SCENE FX effects that were on up to this point also turn off.

Switching the audio signal path

The audio signals input to this unit's [INPUT] terminals pass through the effect circuitry inside this unit and are then output from this unit's [OUTPUT] terminals.

This unit's effect circuitry includes three sections, positioned in the following order: the RHYTHM FX section, the SCENE FX section, and the RELEASE FX section.

Of these three effect sections, the order of the RHYTHM FX and SCENE FX sections can be inverted.

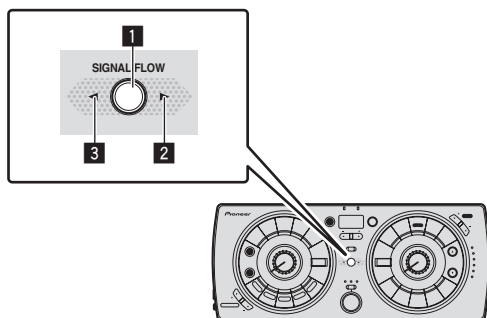

Press the [SIGNAL FLOW] (1) button.

The audio signal path switches as shown on the diagram below each time the button is pressed.

- When the right indicator (2) is lit

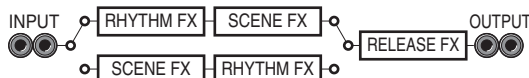

- When the left indicator (3) is lit

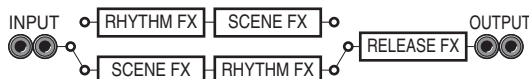

Customizing the effect parameters

The [CUSTOMIZE SHIFT] button can be used to customize the parameters of this unit's effects.

The customized parameters are immediately reflected in this unit's operation.

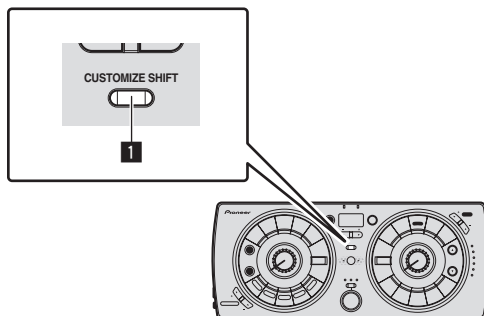

While pressing the [CUSTOMIZE SHIFT] button (1), press the button of the effect you want to customize.

The type and beat of the respective effect switches.

- The effect type and beat can only be customized while the [CUSTOMIZE SHIFT] button is being pressed.
- Buttons that are not lit cannot be customized.
- For the RELEASE FX function, the selected effect's beat switches each time the [RELEASE FX] button is pressed.

Using the update function

- Do not turn off this unit's power during the updating procedure.

1 Connect this unit to your computer via a USB cable.

2 Turn on this unit's power while pressing the [RELEASE FX] and [TAP] buttons.

This unit starts up in the updating mode.

3 Run the update software.

The update software can be downloaded from the Pioneer DJ support site below.

<http://pioneerdj.com/support/>

When a dialog box indicating that the update has been completed is displayed on the computer, the update is complete.

4 Briefly turn this unit's power off and then turn it on again.

This unit starts with the updates applied.

- If an error occurs during updating, the type of error is indicated by the BPM display and the number of segments of the [SCENE FX] indicator that are lit.

Using RMX-500 Plug-in

Setting the RMX-500 Plug-in

❖ Launch the RMX-500 Plug-in in the host application

For instructions on launching the plug-in, see the host application's operating instructions.

Operating the RMX-500 Plug-in

Here we explain how to operate this software. Operation is basically the same as on the RMX-500. The explanations in this section focus on the functions specific to this software.

❖ RMX-500 Plug-in display screen



1 Settings button

This opens this software's settings screen.

- Credits
Displays the trademark, version and the like of this software.

2 Link button

This sets so that the software can be operated from the RMX-500. For details, see *Connecting with the RMX-500 and operating the software*.

❖ Connecting with the RMX-500 and operating the software

This software can be operated from the RMX-500.

1 Connect the RMX-500 unit and the computer with a USB cable, and check that the [Link] button in the software is lit white.

2 When the [Link] button on this software is lit white , press the [Link] button to turn it blue.

- Multiple instances of this software can be activated simultaneously. When multiple instances of this software have been activated, the [Link] button on one instance only will turn blue, and can be operated from RMX-500. On all other instances, the [Link] button turns white automatically, and the instance cannot be operated.
- This software can be used standalone to apply effects without connecting to the RMX-500.

Additional information

Troubleshooting

- Incorrect operation is often mistaken for trouble or malfunction. If you think that there is something wrong with this component, check the points below and the [FAQ] for the [RMX-500] on the Pioneer DJ support site. <http://pioneerdj.com/support/>
Sometimes the problem may lie in another component. Inspect the other components and electrical appliances being used. If the problem cannot be rectified, ask your nearest Pioneer authorized service center or your dealer to carry out repair work.
- The player may not operate properly due to static electricity or other external influences. In such cases, normal operation may be restored by unplugging the power cord then plugging it back in.

Problem	Check	Remedy
The power is not turned on.	Are the included power cord and AC adapter properly connected?	Properly connect the included power cord to a power outlet. Properly connect the power cord to the included AC adapter. (page 6) Connect the included AC adapter's DC plug properly to this unit.
	Is the [ON, STANDBY] switch for power supply set to [ON]?	Set the [ON, STANDBY] switch for power supply to [ON].
	When power is being supplied by USB bus, is the included USB cable properly connected? Are you using a USB hub?	Connect the included USB cable properly. (page 6)
No sound or small sound.	Are the connection cables properly connected?	Connect the connection cables properly. (page 6)
	Are the terminals and plugs dirty?	Clean the terminals and plugs before making connections.
	Is the [INPUT] peak level indicator lit?	Adjust the output level of the connected device.
Distorted sound.	Is the [INPUT] peak level indicator or the [OUTPUT] peak level indicator lit red?	Switch the [SIGNAL LEVEL] selector switch according to the output level of the connected device. (page 8) Adjust the output level of the connected device.
	Tempo (BPM) cannot be measured or measurement value of tempo (BPM) is implausible.	Adjust the output level of the connected device and switch the [SIGNAL LEVEL] selector switch according to the output level of the connected device so that the [INPUT] peak level indicator lights at an appropriate level. For some tracks, it may not be possible to measure the tempo (BPM). Use the [TAP] button to input the tempo manually. (page 10)
	Customized settings are not stored.	Wait at least 10 seconds after customizing settings before turning the power off.
Value of the measured tempo (BPM) differs from value recorded on CD, or tempo (BPM) values displayed on DJ player, DJ mixer, DJ software and this unit differ.	—	The values may differ slightly due to the different ways in which the BPM is measured.
This unit is not recognized after it has been connected to a computer.	Is the included USB cable properly connected?	Connect this unit and computer directly, not via a USB hub.

About trademarks and registered trademarks

- Pioneer is a registered trademark of PIONEER CORPORATION.
- Microsoft, Windows and Windows Vista are either registered trademarks or trademarks of Microsoft Corporation in the United States and/or other countries.
- Apple, Mac and Mac OS are trademarks of Apple Inc., registered in the U.S. and other countries.
- Intel and Intel Core are trademarks of Intel Corporation in the U.S. and/or other countries.
- VST is a trademark of Steinberg Media Technologies GmbH.
- The Audio Units logo is a trademark of Apple Inc.
- RTAS is a registered trademark of Avid Technology, Inc. or its subsidiaries in the United States and/or other countries.

The names of companies and products mentioned herein are the trademarks of their respective owners.

Cautions on copyrights

Recordings you have made are for your personal enjoyment and according to copyright laws may not be used without the consent of the copyright holder.

- Music recorded from CDs, etc., is protected by the copyright laws of individual countries and by international treaties. It is the full responsibility of the person who has recorded the music to ensure that it is used legally.

- When handling music downloaded from the Internet, etc., it is the full responsibility of the person who has downloaded the music to ensure that it is used in accordance with the contract concluded with the download site.

General Disclaimer

Please note that Pioneer will accept no responsibility whatsoever concerning legality, morality, operation stability, etc., when using software that was downloaded by the user. Problems may occur in operation of downloaded software, depending on the operating environment of the computer being used and the downloaded software or compatibility with other software.

Please note that Pioneer will accept no responsibility whatsoever for loss of information the user has registered using downloaded software. Write down the information you have registered in a note, etc., for safe keeping.

- The specifications and design of this product are subject to change without notice.

© 2014 PIONEER CORPORATION. All rights reserved.

PIONEER CORPORATION

1-1, Shin-ogura, Saiwai-ku, Kawasaki-shi, Kanagawa 212-0031, Japan
<DRI1210-B>