

The Lighting Company

Top 48

Universal DMX Controller



GB *USER'S MANUAL*

INDEX

We congratulate you on your purchase of TOP 48.

Before you proceed using this product it should be necessary to read carefully the following user's manual to install it correctly and to get the best of its potentialities.

Setting of the equipment

- 1.1 Description of the front panel
- 1.2 Unpacking of the equipment
- 1.3 Accessories issued with the equipment and relative documentation

Description of the rear panel and installation

- 2.1 Description of the rear panel
- 2.2 Input connection for power supply
- 2.3 Connection of the ballast to the electric system
- 2.4 DMX 512 **Output/Input** connection
- 2.5 Example of DMX 512 **line connection**

Use of the equipment - initial setting

- 3.1 How to operate with the controller at the first use

Use of the equipment - modes of operation

- 4.1 **SCENE** mode
- 4.2 Function keys in **SCENE** mode
- 4.3 **EDIT** in **SCENE** mode
- 4.4 Select in **EDIT SCENE** mode
- 4.5 **EDIT SCENE** mode
- 4.6 Function keys in **EDIT SCENE** mode
- 4.7 Channels adjustment faders in **EDIT SCENE** mode
- 4.8 **PAN** and **TILT** channels adjustment through the Joystick
- 4.9 **MASK** function in scene mode
- 4.10 **MAN** mode

- 5.1 **EDIT PROGRAM** mode
- 5.2 Function keys in **EDIT PROGRAM** mode
- 5.3 Select in **PROGRAM** mode
- 5.4 Function keys in **PROGRAM** mode

- 6.1 **CHASE** mode
- 6.2 Function keys in **EDIT CHASE** mode
- 6.3 Select in **CHASE** mode
- 6.4 Function keys in **CHASE** mode
- 6.5 **STEPS** mode
- 6.6 Function keys in **STEPS** mode
- 6.7 **EDIT STEPS** mode
- 6.8 Function keys in **EDIT STEPS** mode
- 6.9 Channels adjustment faders in **EDIT STEPS** mode
- 6.10 **MASK** function in steps mode
- 6.11 Use of **MASTER DIMMER** fader

- 6.12 Use of **MASTER CHASE** fader

- 7.1 **EFFECT** mode
- 7.2 Function keys in **EFFECT** mode
- 7.3 Select in **EFFECT** mode
- 7.4 **EDIT** in **EFFECT** mode
- 7.5 **EDIT EFFECT** mode
- 7.6 Function keys in **EDIT EFFECT** mode

- 8.1 **SHOW** mode
- 8.2 Function keys in **SHOW** mode
- 8.3 **GO SHOW** mode
- 8.4 **EDIT** in **SHOW** mode
- 8.5 Select in **EDIT SHOW** mode

Example of working

- 9.1 Creation of a **PROGRAM**
- 9.2 Creation of a **CHASE**
- 9.3 Creation of an **EFFECT**
- 9.4 Creation of a **SHOW**

Example of usage - menu functions

- 10.1 **MENU** Function
- 10.2 **MENU: BLACKOUT**
- 10.3 **MENU: LAMP ON - LAMP OFF**
- 10.4 **MENU: RESET UNITS**
- 10.5 **MENU: FADERS FUNCTIONS**
- 10.6 **MENU: FADERS FUNCTIONS LIVE**
- 10.7 **MENU: EDIT DMX PATCH**
- 10.8 Function keys in **EDIT DMX PATCH** mode
- 10.9 **LOAD LIBRARY** in **EDIT DMX PATCH** mode
- 10.10 Function keys in **LOAD LIBRARY** mode
- 10.11 **EDIT** in **EDIT DMX PATCH** mode
- 10.12 **EDIT** of **DMX CHANNELS**
- 10.13 Function keys in **EDIT** of **DMX CHANNELS** mode
- 10.14 **MENU: SYSTEM SETTINGS**
- 10.15 **MENU: SET LCD CONTRAST**
- 10.16 **MENU: SECURITY LOCK**
- 10.17 **MENU: ABOUT TOP 48**
- 10.18 **MENU: RS 232 HOST LINK**

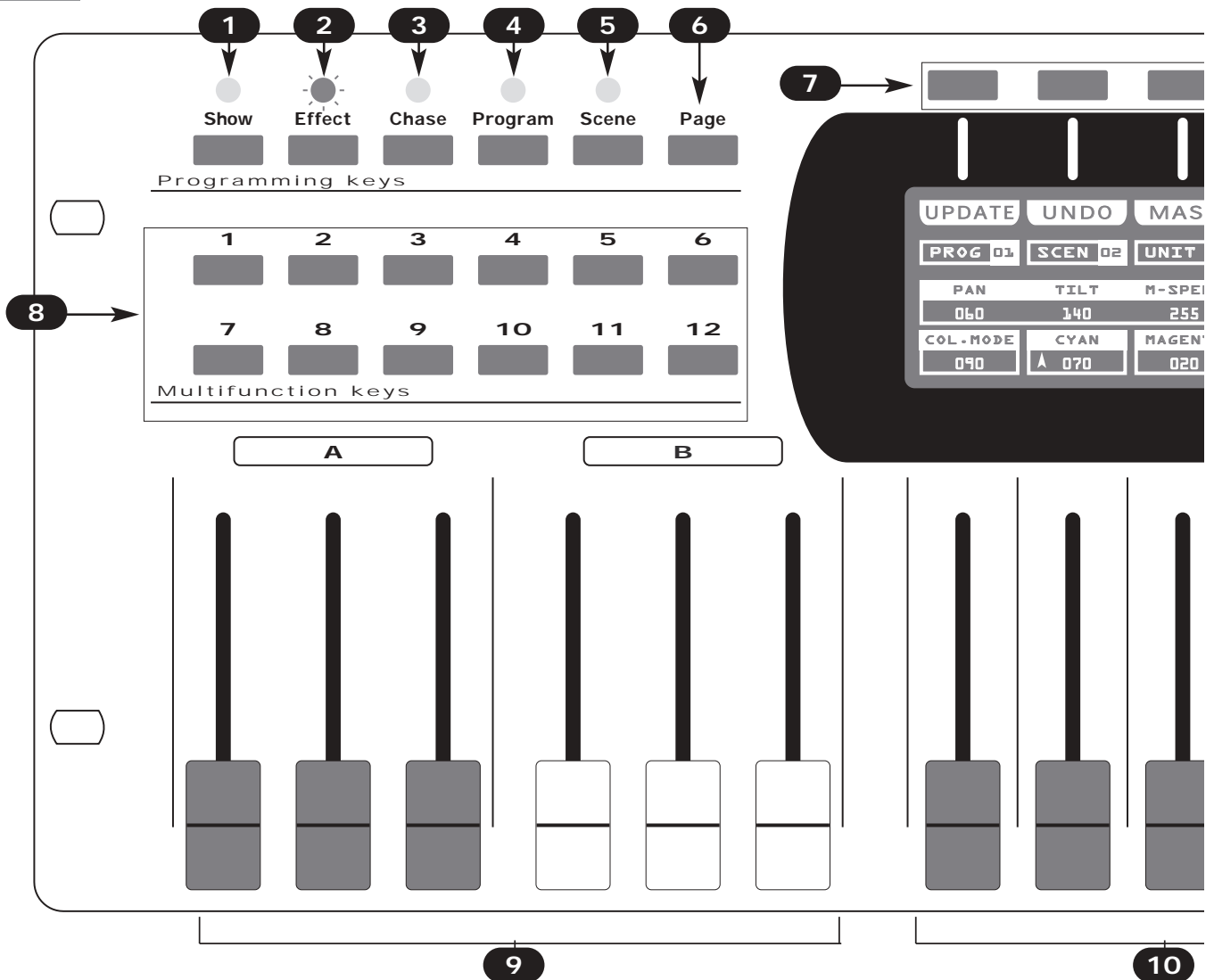

- 1 To activate **SHOW** function
- 2 To activate **EFFECT GENERATOR** function
- 3 To activate **CHASE** function
- 4 To activate **PROGRAM** function
- 5 To activate **SCENE** function
- 6 Go to the next **Page**
- 7 Function keys
- 8 Select the active function,
UNIT/SCENE/PROGRAM/CHASE/EFFECT/SHOW.....
- 9 Channels adjustment faders from 0 to 255
Menù assign possibility function.
- 10 Channels adjustment faders from 0 to 255

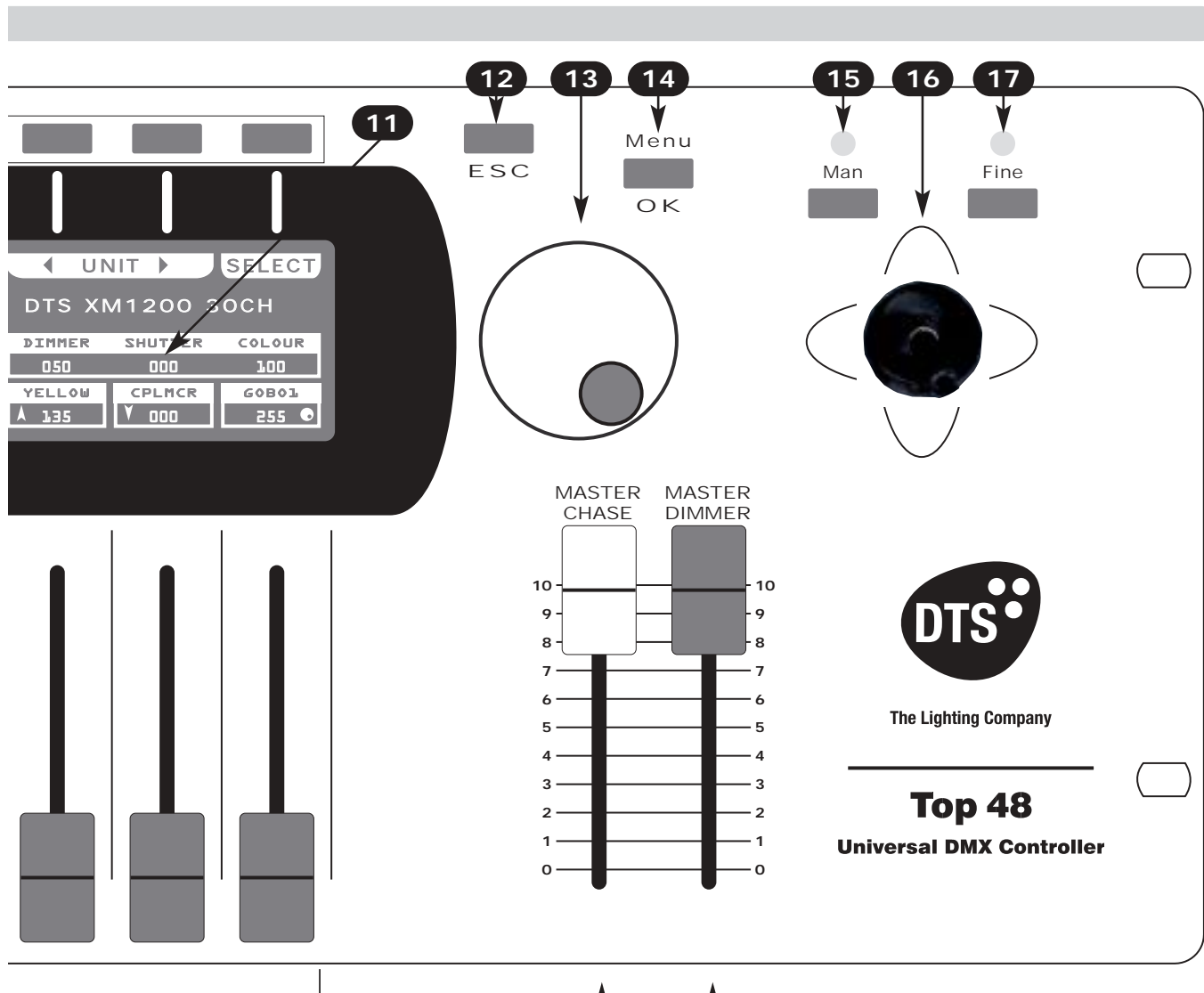

- 11** Graphic Display
- 12** Esc/annulment key
- 13** Encoder
- 14** Menu/confirmation key
- 15** To activate MAN function
- 16** Joystick: it allows an easy positioning of the unit.
- 17** To activate FINE function for the joystick
- 18** MASTER CHASE Fader : it change the value from 0 to 255 of the CHASE.
- 19** MASTER DIMMER Fader : it change the value from 0 to 255 of the all DIMMER unit channels.

1.2 UNPACKING OF THE EQUIPMENT

GB

Open the box; take the ballast and the documentation out.

Take the equipment out of the box as shown in the picture below.

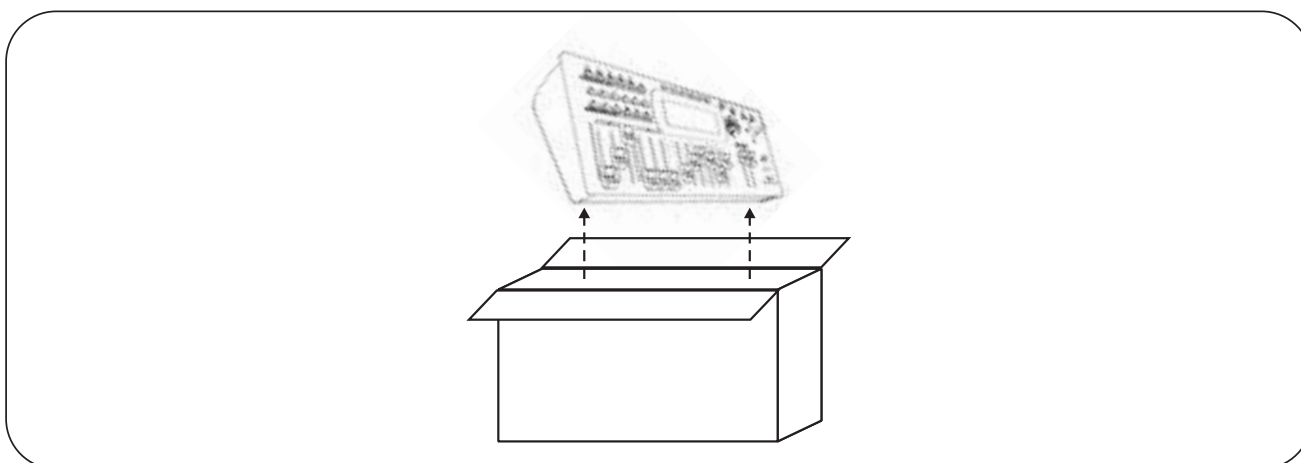

1.3 ACCESSORIES ISSUED WITH THE EQUIPMENT AND RELATIVE DOCUMENTATION

Verify the contents of the packing.

If one of the following parts of the packing is missing or damaged, please, contact your dealer immediately.

- Top 48
- User's manual.
- Warranty
- 1 XLR 5 P male connector
- 1 Ballast mod. mtrx 12Vac
- 1 Cable male/female RS 232

Read the following warnings before beginning installation.

- This unit is not intended for home use.
- Read this manual thoroughly and observe the following precautions before working with the controller.
- Take care not to spill liquids on to the controller and do not use it in excessively humid conditions.
- Do not install the controller near heat sources or expose it to direct sunlight and do not install in dusty environments without suitable protection.
- Do not use the controller unless the mains cable and plug are in perfect condition (replace or repair if necessary).
- Do not use solvents such as acetone or alcohol to clean the controller or the finish and panel lettering will be damaged.
- If a fault occurs, consult your nearest service centre or a specialized light equipment repair service. Do not attempt to repair the controller yourself.

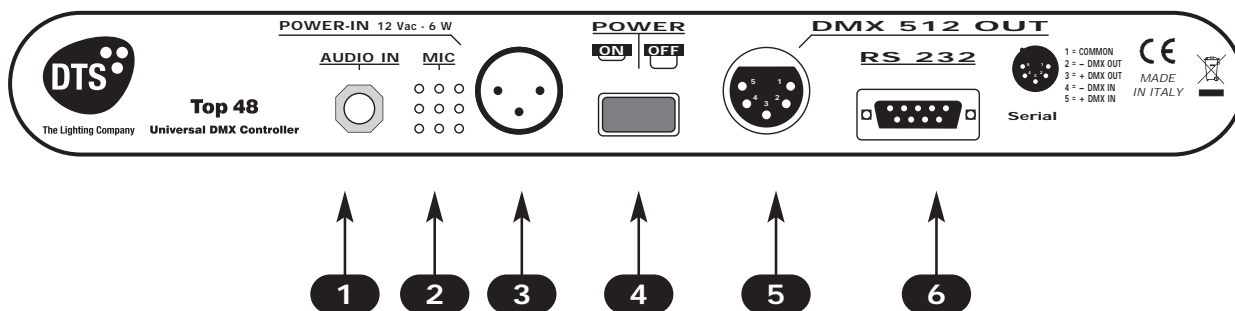

- 1 0 dB audio signal INPUT with a mono/stereo jack connector.
- 2 MICROPHONE for the MUSIC function
- 3 12 Vac power INPUT with a 3-pin cannon connector.
- 4 POWER KEY
- 5 Standard DMX 512 signal INPUT/OUTPUT with a 5-pin cannon connector.
- 6 RS232 signal INPUT.

2.2 INPUT CONNECTION FOR POWER SUPPLY

Plug the 3-pin cannon connector of the ballast completely in the power input **3**

Use the "push" safety hook to disconnect it and extract it gently.

ATTENTION: do not use ballast different from the one supplied, it could cause serious damages at the internal circuitation.

Do not connect the 3-pin cannon connector in other appliances, it has been studied to be used only in this controller.

2.3 CONNECTION OF THE BALLAST TO THE ELECTRIC SYSTEM

MAKE SURE THAT VOLTAGE AND POWER FREQUENCY CORRESPOND TO WHAT IS REPORTED ON THE BALLAST PLATE.

The supplied ballast has a plug, therefore you should only plug it in the socket.

Press **POWER** key to verify the correct installation.

If pressing the **POWER** key no leds light up, please check if there is tension in the electric socket or check the connection between ballast-controller and ballast-electric socket.

If the problem persists, please consult your dealer.

Make sure you are using shielded twisted cables suitable for the transmission of the DMX 512 signal with connectors of good quality and connection as shown on the side of the connector. **5**

Plug the 5-pin XLR connector coming from the unit completely in the DMX 512 output
Use the "push" safety hook to disconnect it and than extract it gently.

ATTENTION: the shielded part of the cable must never be connected to the ground of the electrical system as this could cause faults during the working of the controller

2.5 EXAMPLE OF DMX 512 LINE CONNECTION

TOP 48 has a DMX 512 input/output that uses standard XLR 5-pin connector The input it is for now disabled from the software.

The connection must be put into practice with cable shielded by these characteristics:

- 2 conductors plus screen
- 120 Ohm impedance
- low capacity
- maximum transmission rate 250 Kbaud.

For the connection do reference to the figure.

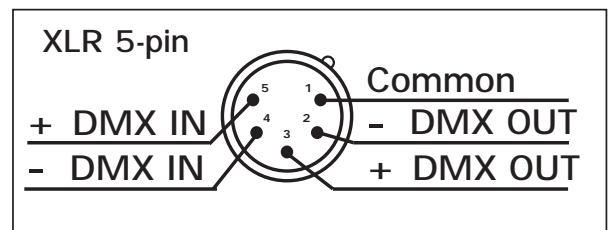

3.1 HOW TO OPERATE WITH THE CONTROLLER AT THE FIRST USE

TOP 48 is a universal DMX controller and is provided with an initial generic configuration. For a correct operation **YOU MUST** configure the controller with the type of projectors/scanner connected to it.

The **SETUP LIBRARY** sheet includes the list of the projectors/scanner contained in the internal memory of the controller, if the requested configuration is not present in the library, you need to make a personalized one.

The operations to configure the controller is described in the user's manual at chapter:

10.7 Function **MENU: EDIT DMX PATCH**

TOP 48 is endowed with graphic display with adjustable contrast from menù, if the initial setting isn't correct, it is possible to change the contrast.

The operations to change contrast is described in the user's manual at chapter:

10.14 Function **MENU: SYSTEM SETTINGS**

THIS FUNCTION ALLOWS TO SEE ONE OF THE 48 SCENES OF THE ACTIVE PROGRAM, CHANGE THE PARAMETERS AND EDITING.

Press **SCENE** key to activate **SCENE** function (Fig. 1)

The **SCENE** key led will light up to indicate the activation of this function, and the display changes as shown in (Fig. 2)

The graphic display indicates the scene (**highlighted**) currently active (Fig. 2) if an empty scene is selected, on the display appears "FREE SCENE".

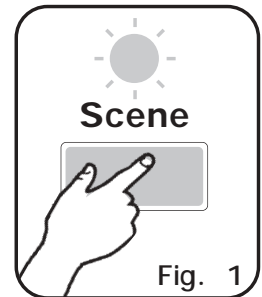

Press one of the 1÷12 keys to select the scene.

Pushes it again, the scene puts on out his end value.

For scenes 13÷24/25÷36/37÷48 use the **PAGE** key

Note: Keep Master Dimmer Faders to the maximum (see par 6.11)

Function Keys see par 4.2

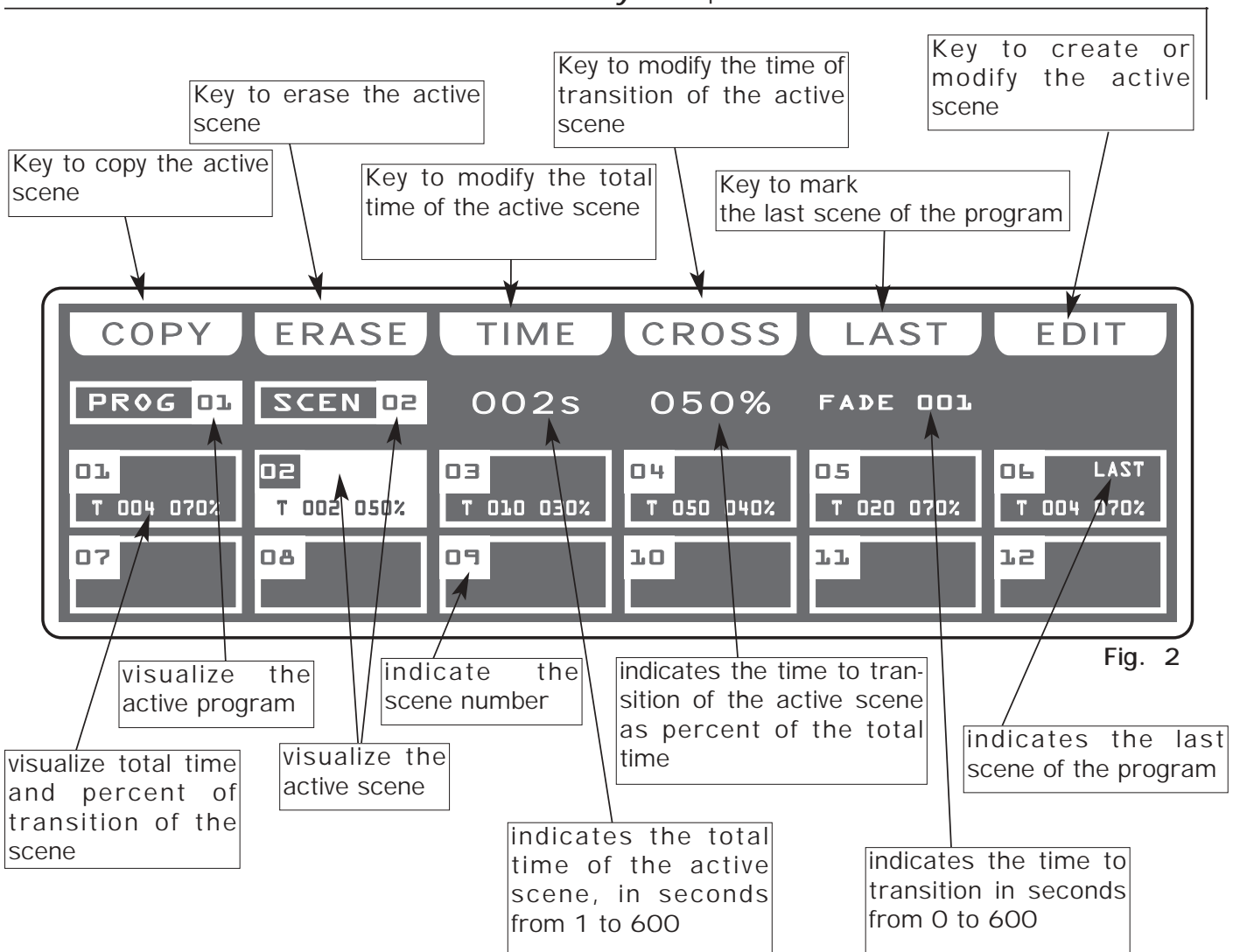

Fig. 2

In **SCENE** mode there are 6 **function keys** see (Fig. 2 par 4.1).

COPY Key:

Pressing this key, the display shows "**SELECT DESTINATION SCENE,**" select through the 1÷12 keys the destination of the copy.

For the successive scenes use **PAGE** key

Note: After have pressed **COPY** key, the same becomes **GRAB** key.

GRAB Key:

Press this key to store, the scene; you can then paste it in an empty scene of the same program or in a different program. The key becomes **PASTE**.

PASTE Key:

Pressing this key the scene previously stored could be pasted to an any empty scene of any program.

ERASE Key:

Press this key to the erase active scene, select through the 1÷12 keys (for the successive scenes use **PAGE** key) the scene that must be erased, then press the **ERASE** key.

The scene will be erased in a permanent way, it is not possible to recover it.

TIME Key:

Press this key to change the total time of the scene, the value is in seconds from 1 to 600, use the fader under the **TIME** writing, or the encoder. For confirm the modify press the **OK** key, for get out of the function press the **ESC** key.

CROSS Key:

Press this key to modify the time of transition of the scene, the value is expressed in percent from 0 to 100%, use the fader under the **CROSS** writing, or the encoder. For confirm the modify press the **OK** key, for get out of the function press the **ESC** key.

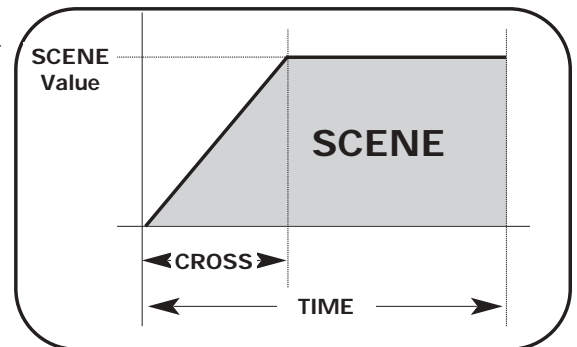

LAST Key:

Press this key to select the last scene of the program, select through the 1÷12 keys (for the successive scenes use **PAGE** key) the scene where you want to terminate the program, then press the **LAST** key.

For the successive scenes use **PAGE** key

Note: The last scene of the program will be stored automatically in **EDIT** mode.

EDIT Key:

Press this key to create/modify the active scene see par. 4.3 **EDIT IN SCENE mode**

THIS FUNCTION ALLOWS TO EDIT ONE OF THE 48 SCENES OF THE ACTIVE PROGRAM.

The graphic display indicates the scene (**highlighted**) currently active (Fig. 2 par 4.1) for create/modify it press the **EDIT** key (Fig. 3).

The display changes as shown in (Fig. 4).

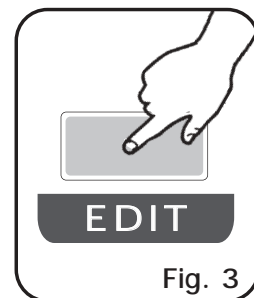

Fig. 3

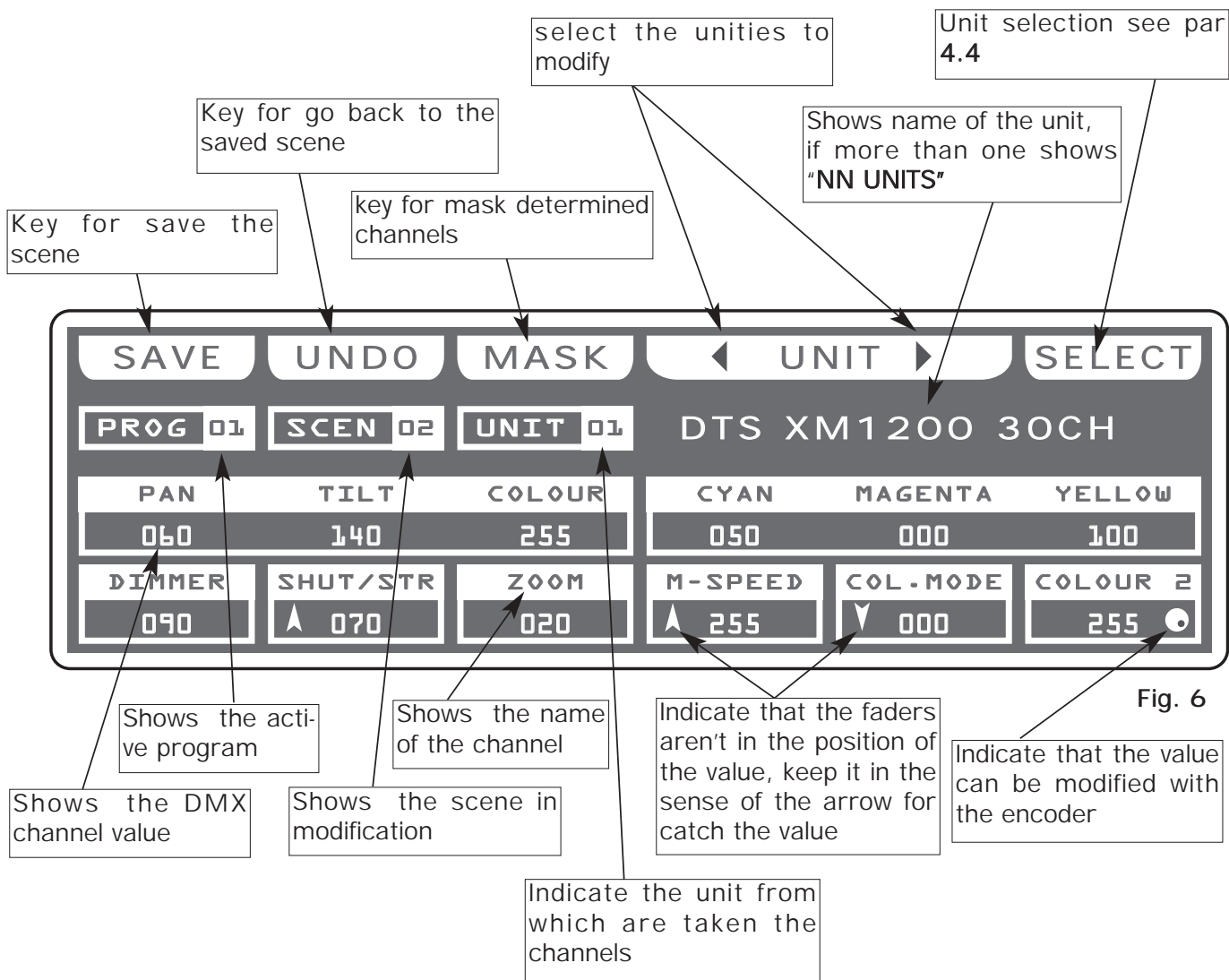

Fig. 6

THIS FUNCTION ALLOWS TO SELECT ONE OR MORE UNIT OF THE ACTIVE PROGRAM.

To activate the multiple selection of the unit press the **SELECT** key (Fig. 4 par 4.3).

The display changes as shown in (Fig. 5).

Press one of the 1÷12 keys to activate one or more the unit.

For successive units use the **PAGE** key

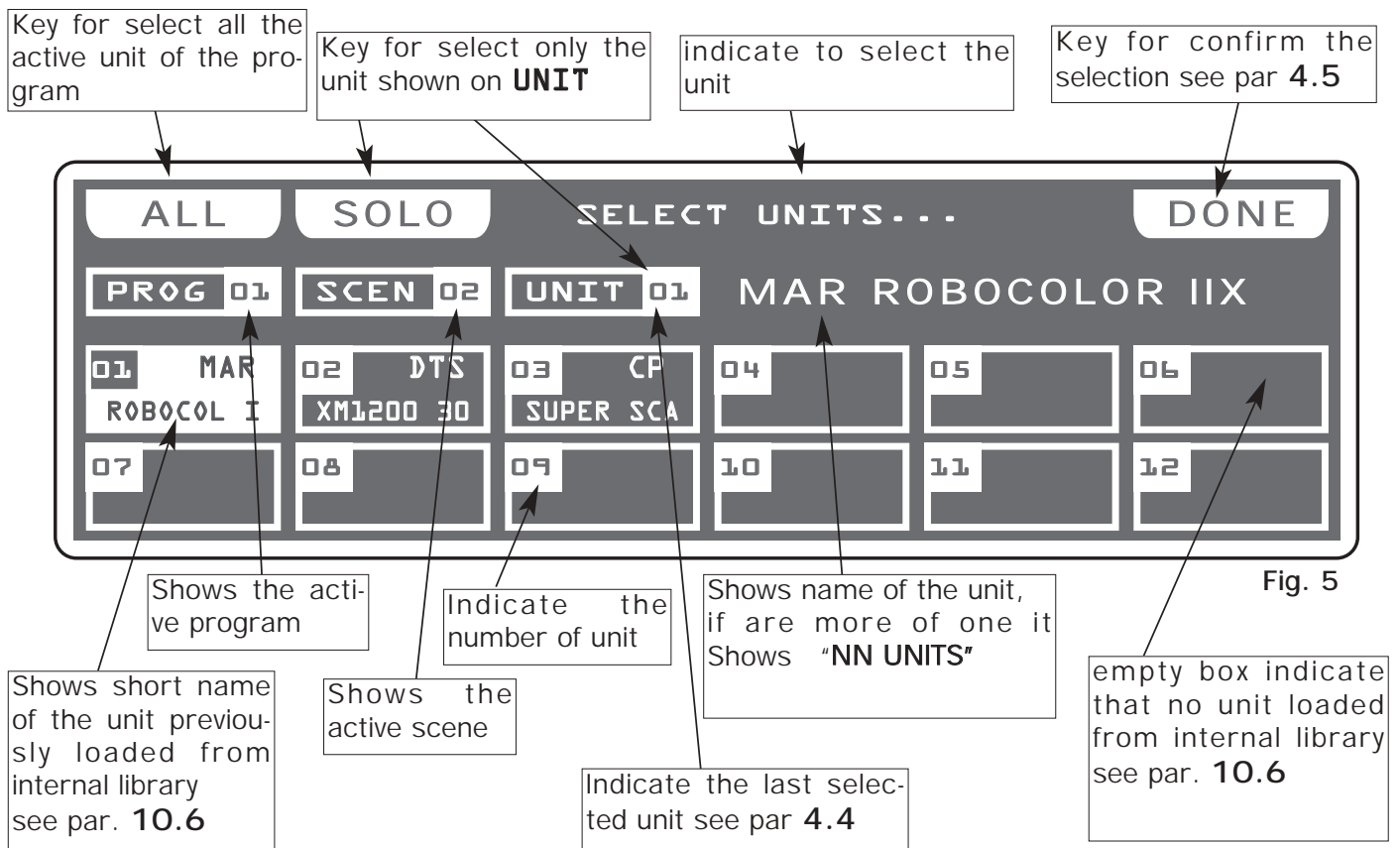

ALL Key:

Press this key to select all the units previously assign to the program, it isn't possible select unit if not active in the program.see par. 5.2.

Pressing this key the display shown "**NN UNITS**", the DMX control channels will taken from the unit shown in the box **UNIT ..**

SOLO Key:

Press this key to select only the unit shown in the box **UNIT ..**, if we have selected with the **ALL** key all the **48** unit, and we wants to change the value of the unit channels (es. n° **02**), press twice the key **02** of selection unit. The unit box will indicate **UNIT 02** now the **SOLO** key unselect all the other unit, activating **SOLO** the **UNIT 02**

DONE Key:

Pressing this key you confirm the selection of the unit see par. 4.5.

THIS FUNCTION ALLOWS TO MODIFY THE VALUE OF THE CHANNELS OF THE UNITIES SELECTED

Through the 12 faders you regulate the value of corresponding channel see par 4.7 Pressing one of the 1÷12 keys the correspondent channel can be modified with the encoder.

For successive channels use the **PAGE** key

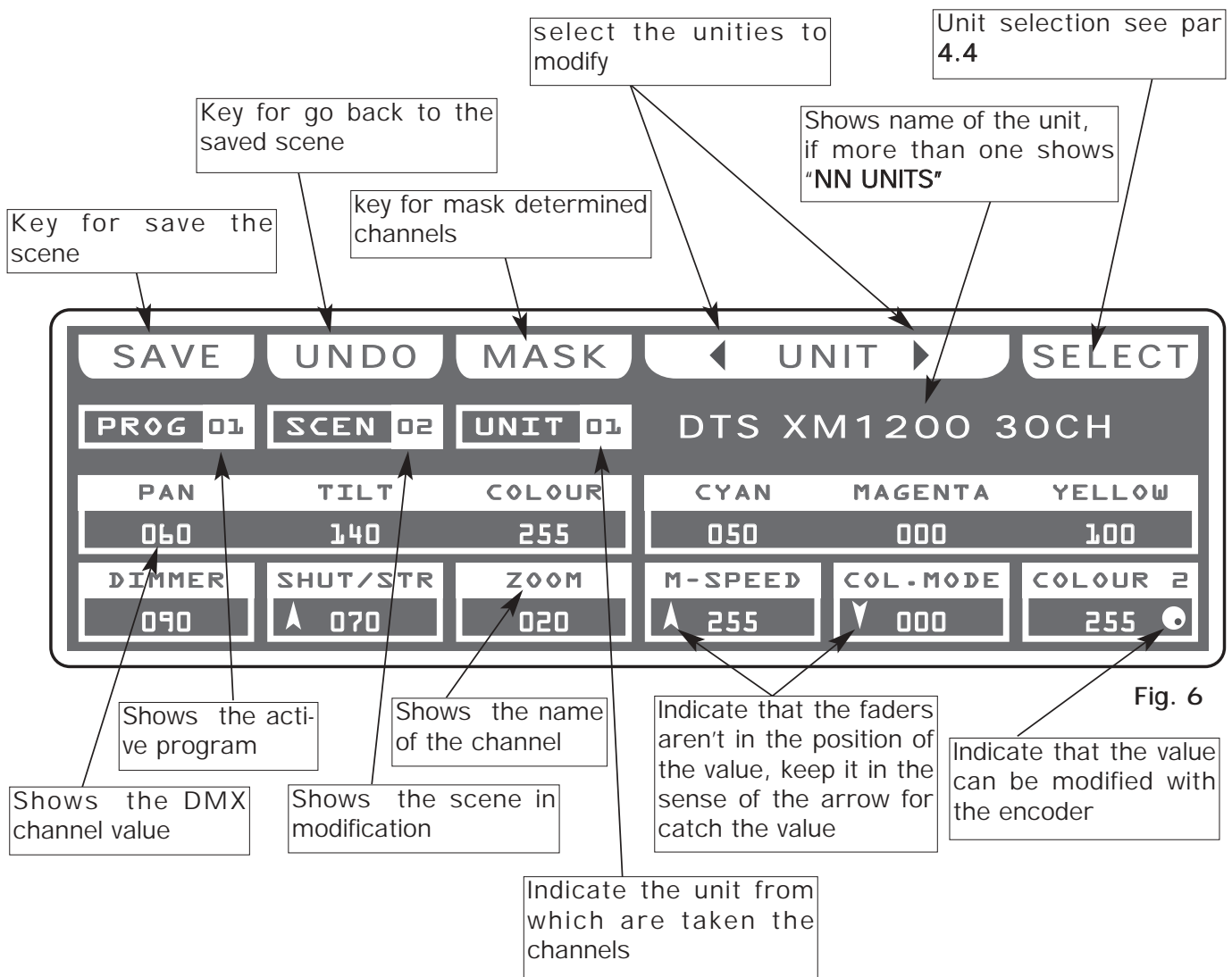

Fig. 6

4.6 FUNCTION KEYS IN EDIT SCENE MODE

In **EDIT SCENE** mode there are 6 function keys see (Fig. 6 par 4.5).

SAVE/UPDATE key:

Press the **SAVE** key to save the free scene and go to the next free scene

The **UPDATE** key allow you to update the saved scene and go back to the scene function see par 4.1

UNDO key:

Pressing this key you go back to the saved scene

MASK key:

Press this key to activate the mask function. see par 4.8

UNIT key:

Press this keys to select the successive/precedent unit

SELECT key:

Pressing this key you go back to the unit selection see par 4.3

4.7 CHANNELS ADJUSTMENT FADERS IN EDIT SCENE MODE

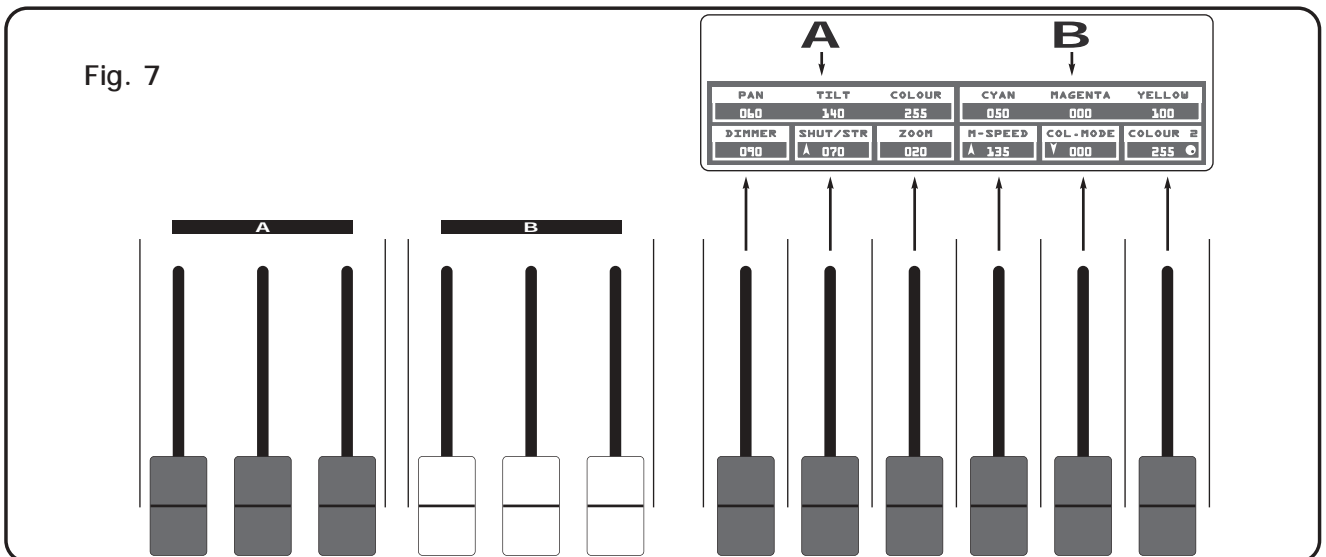

The 12 faders are used to adjust the channels value see (Fig. 7)

For modify the scene, keep the faders to desired values.

Each time that changes page the faders remains inactive.

The arrow in the box ndicate that the fader aren't in the position of the value, keep it in the sense of the arrow for catch the value. If you select more unit at the same time, the names of the channels and the suitable values do reference to the uintn signalled from the box unit. **You can not modify the value of the channels: PAN LOW / TILT LOW / LAMP / LAMP-RES.** For modify the value see par 10.6

N.B. The 6 single boxes (under part of the display) do reference to the faders immediately under. The two boxes from 3 channels (above to the single) do reference respectively:

The left box at 3 faders "A"

The right box at 3 faders "B"

Using the joystick the PAN and TILT channels of the scanner's mirror and moving heads can be adjusted (Fig.8).

The joystick type is with central return, thanks to the sophisticated software of management, it allows an easy and exact positioning.

The mirror's speed movement could be changed through the **Fine** key

Every time you press the **Fine** key the selected speed it is shows for 3 seconds on the graphic display (Fig. 9).

With **SPEED 01/10** the joystick moves the mirror with a fixed speed, with **SPEED PROP** joystick become proportional type, if you leave the joystick in central position the mirror keeps still; whereas the more you move it away from the centre the faster the mirror will run.

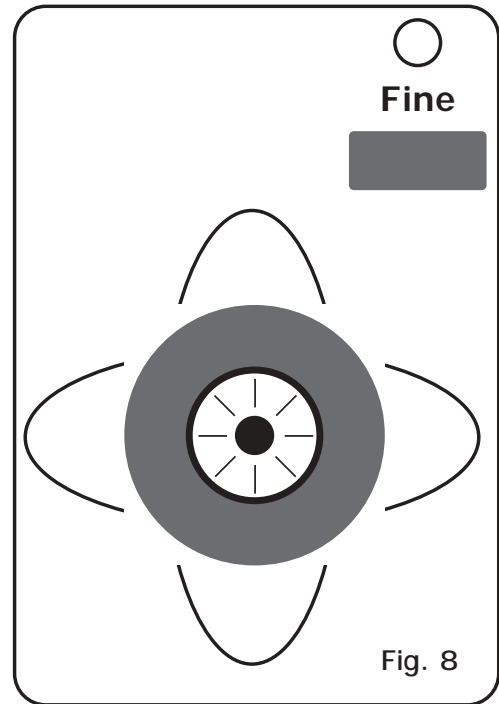

Pressing twice the **Fine** key joystick passes directly to the fine movement mode. The **Fine** key led will light up to indicate the activation of this function. Useful function for control moving heads

Joystick movement change the **PAN/PAN LOW** and **TILT/TILT LOW** output channels.

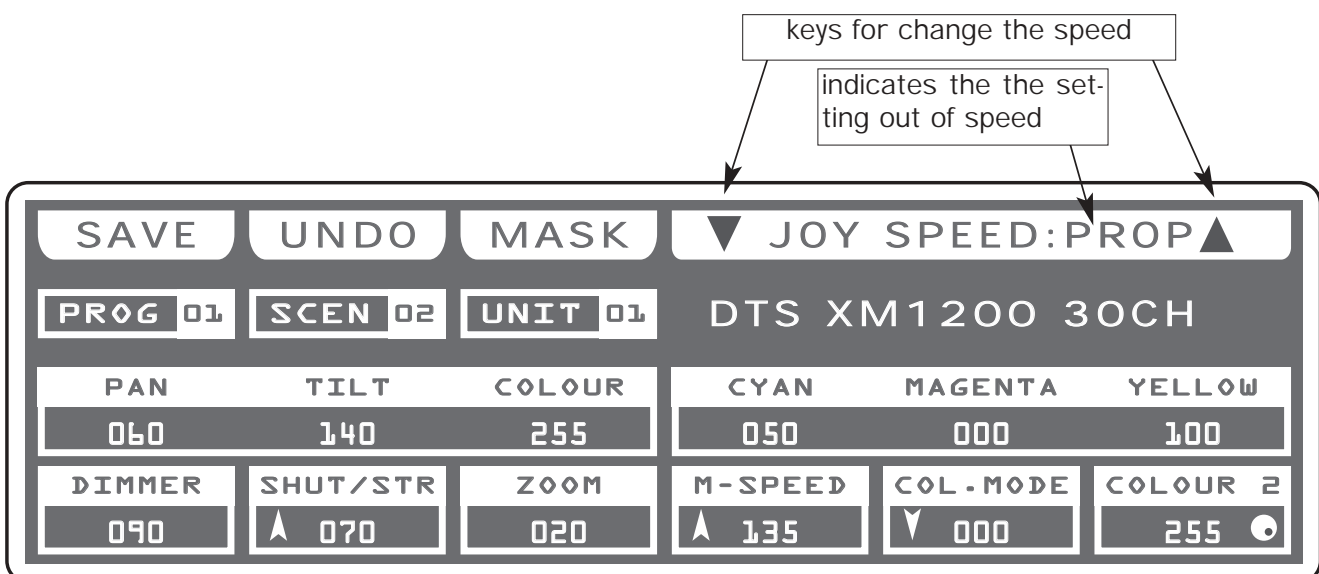

Fig. 9

THIS FUNCTION ALLOWS TO MASK THE CHANNELS OF THE PREVIOUSLY SELECTED UNIT IN A DETERMINED SCENE.

Press **MASK** key to activate **MASK** function (Fig. 10)

The display changes as shown in (Fig. 11)

The graphic display indicates the channels masked with the symbol"===" (Fig. 11)

The operator in this case masks the tilt, cyan, magenta and yellow channels. When you recall the scene The masked channels stay to the value planned in precedence.

Very useful function for create scenes that make only change color etc.



Fig. 10

Press one of the 1÷12 keys to masks the correspondent channels.
For successive channels use the **PAGE** key

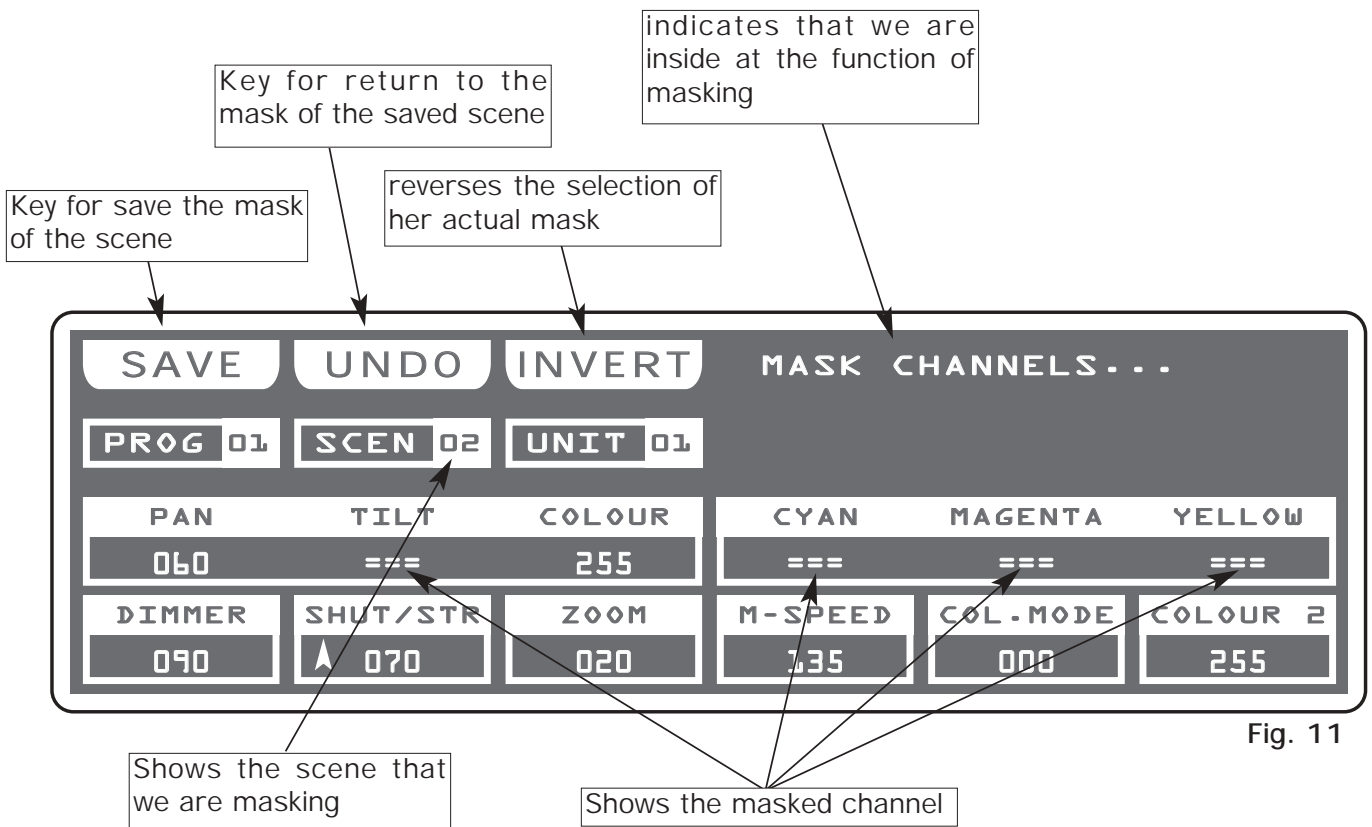

Fig. 11

INVERT key:

Press this key to reverse the selection of the actual mask, in the case of the (Fig. 9) the tilt, cyan, magenta and yellow channels becomes modifiable, while the others comes masked.

THIS FUNCTION ALLOWS TO ACTIVATE ONE OR MORE UNIT WHILE THE NOT SELECTED ONES GO ON PERFORMING THE OWN FUNCTION.

Press **MAN** key to activate **MAN** function (Fig. 12).

The **MAN** key led will light up to indicate the activation of this function, and the display changes as shown in (Fig. 5 see par 4.4).

Do reference to the par 4.4 for the keys function, except for the **DONE** key:

Pressing **DONE** key the function is activated, and the display changes as shown in (Fig. 13).



Fig. 12

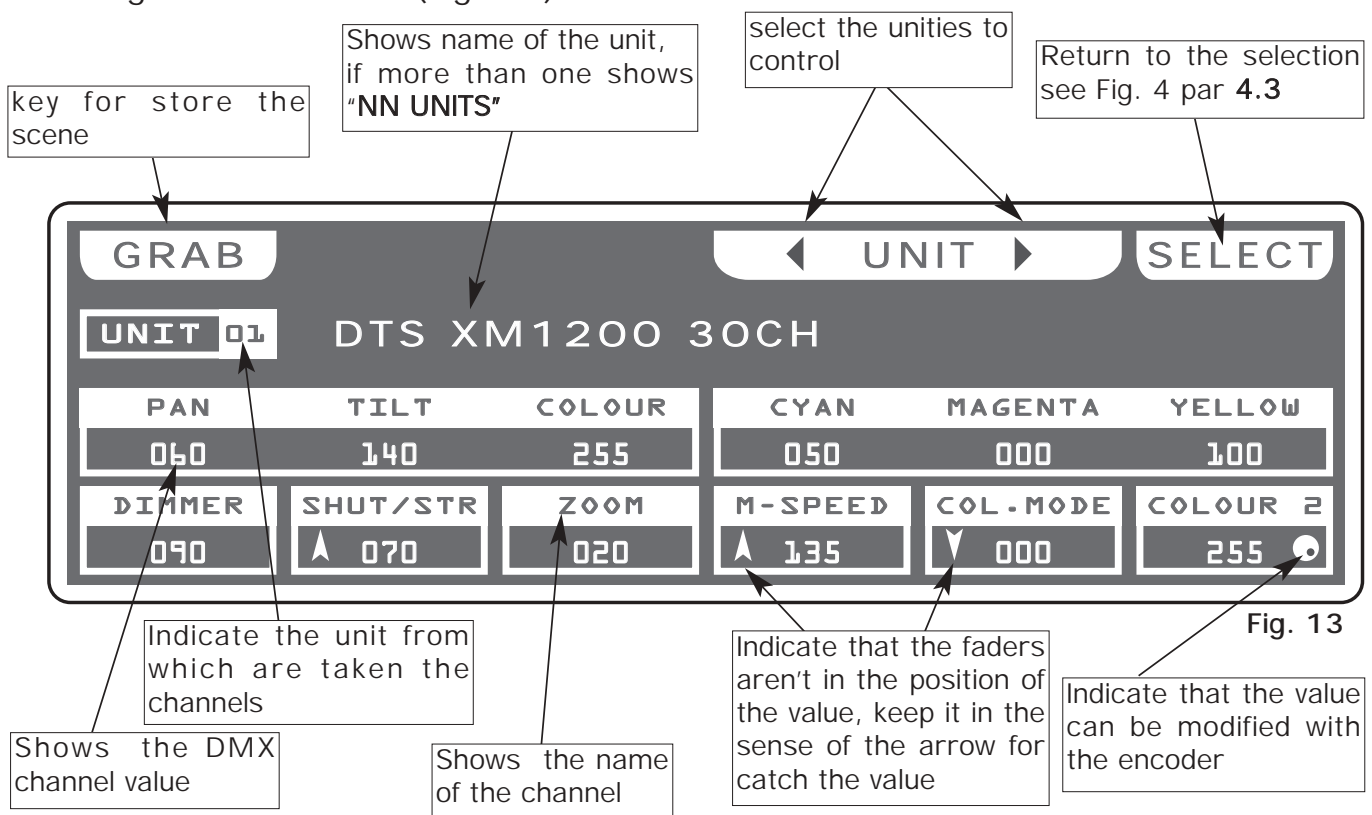

Fig. 13

In **MAN** mode there are 4 function keys see (Fig. 13).

Key **GRAB**:

Press this key to store the scene, you can then paste it in an empty scene of any program.

Tasti **UNIT** :

Press this keys to select the successive/precedent unit

Key **SELECT**:

Pressing this key you go back to the unit selection see (Fig. 4 par 4.3).

THIS FUNCTION ALLOWS TO ACTIVATE A PROGRAM AND CHANGE THE PARAMETERS OF THE SAME.

A PROGRAM IS A SEQUENCE OF SCENES (STATIC) , EXECUTE IN SEQUENCE FROM 1 TO MAX 48.

Press **PROGRAM** key to activate *PROGRAM* function.
(Fig. 14)

The **PROGRAM** key led will light up to indicate the activation of this function, and the display changes as shown in (Fig. 15).

The graphic display indicates the program (**highlighted**) currently active (Fig. 15).

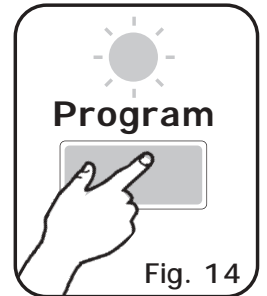

Press one of the 1÷12 keys to select the program.
For successive programs use the **PAGE** key.

Function Keys see par 5.2

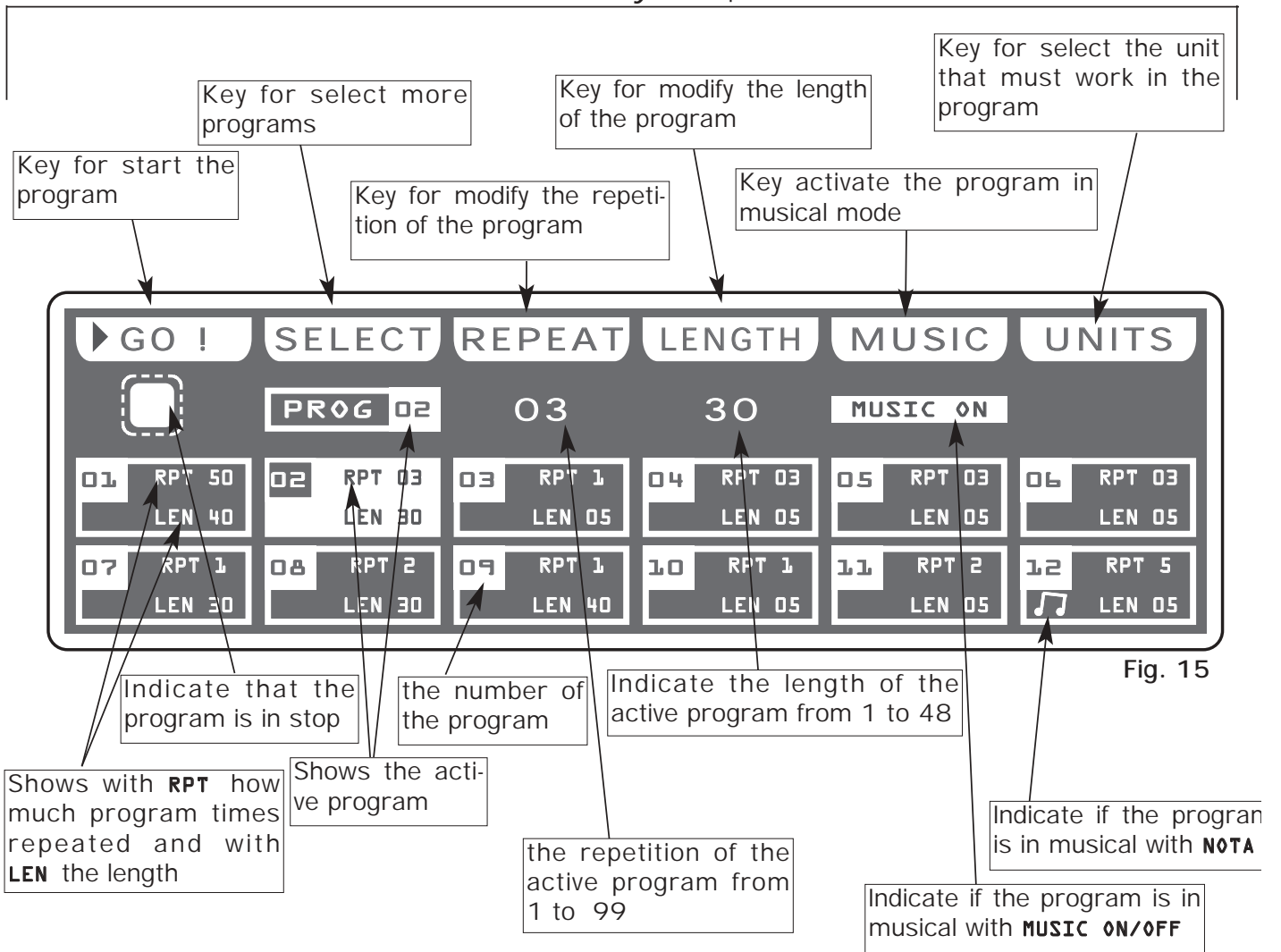

Fig. 15

In **EDIT PROGRAM** mode there are 6 **function keys** see (Fig. 15 par 5.1)

GO key:

Press this key to start the program.

Note: Keep Master Dimmer Faders to the maximum (see par 6.11)

The key becomes **PAUSE** the display changes as shown in (Fig. 15 par 5.3)

PAUSE key:

Press this key to stop the program in the current position, pressing the **GO** key it recovers from the same position.

SELECT key:

Pressing this key it is possible the multiple selection of the programs. The display changes as shown in (Fig. 14) see par 5.3

Press one of the 1÷12 keys to select the program.

For successive programs use the **PAGE** key.

REPEAT key:

Press this key to modify the number of repetitions of the program, the value is in number from 1 to 99 use the faders under the **REPEAT** writing, or the encoder. For confirm the modify press the **OK** key, for get out of the function press the **ESC** key.

LENGTH key:

Press this key to set how many scenes of the program will execute, the value is in number from 1 to 48 use the faders under the **LENGTH** writing, or the encoder. For confirm the modify press the **OK** key, for get out of the function press the **ESC** key.

MUSIC key:

Pressing this key, and activating **MUSIC ON**, the active program will change the scenes to time of music, in the box of the program and to the side at symbol play the display shows a note.

The internal music sensor has an automatic gain adjustment which allows to have a signal level good for **Top 48** working.

The input music signal is a OdB mono/stereo so it could be taken from sound sources like Mixer, CD, Dat etc.

UNITS keys:

Press this key to set what unit will be active in the program.

For successive units use the **PAGE** key.

THIS FUNCTION ALLOWS TO SELECT A SERIES OF PROGRAMS

For activate the multiple selection of the programs you must press the **SELECT** key (Fig. 16).

The display changes as shown in (Fig. 17).



Press one of the 1 ÷ 12 keys to select more programs.
For successive programs use the **PAGE** key.

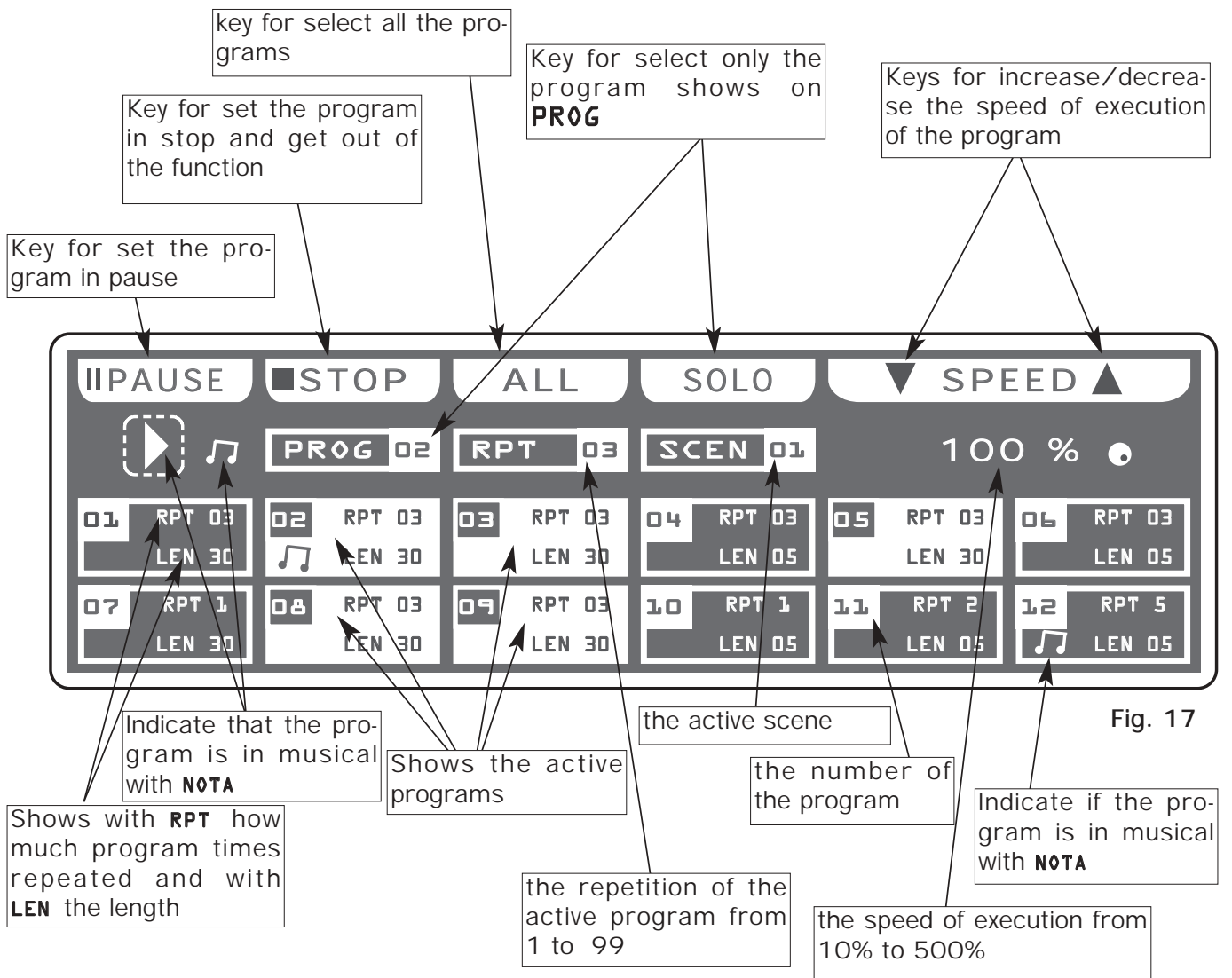

In **PROGRAM** mode there are 6 **function keys** see (Fig. 17 par 5.3).

PAUSE key:

Press this key to stop the program in the current position, pressing the **GO** key it recovers from the same position.

STOP key:

Press this key to stop the program with return to the function edit program see (par 5.1), pressing the **GO** key it start from the first scene.

ALL key:

Press this key to select all the program from 1 to 48.

SOLO key:

Press this key to select only the program shown in the box **PROG**, if we have selected with the **ALL** key all the **48** program, and we wants to selectd only the program (es. n° **02**), press twice the key **02** of program selection. The prog box will indicate **PROG 02** now the **SOLO** key unselect all the other program, activating **SOLO** the **PROG 02**

SPEED key:

Pressing one of these two keys will be increased/decreases the speed of execution of the program the value is in percent and varied from 10% at 500%. To the value 100%. the speed of execution is that planned in the scenes.

THIS FUNCTION ALLOWS TO ACTIVATE A CHASE AND CHANGE THE PARAMETERS OF THE SAME.

A CHASE IS A PLAY OF LIGHTS, IT IS A SEQUENCE OF STEPS (FROM 1 TO 48 MAX).

Press **CHASE** key to activate **CHASE** function (Fig. 18)

The **CHASE** key led will light up to indicate the activation of this function, and the display changes as shown in (Fig. 18).

The graphic display indicates the chase (**highlighted**) currently active (Fig. 19).

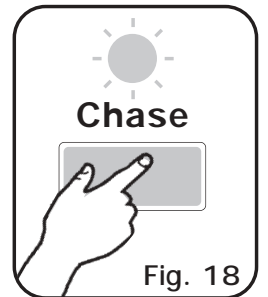

Fig. 18

Press one of the 1÷12 keys to select the chase.
For successive chases use the **PAGE** key

Function Keys see par 6.2

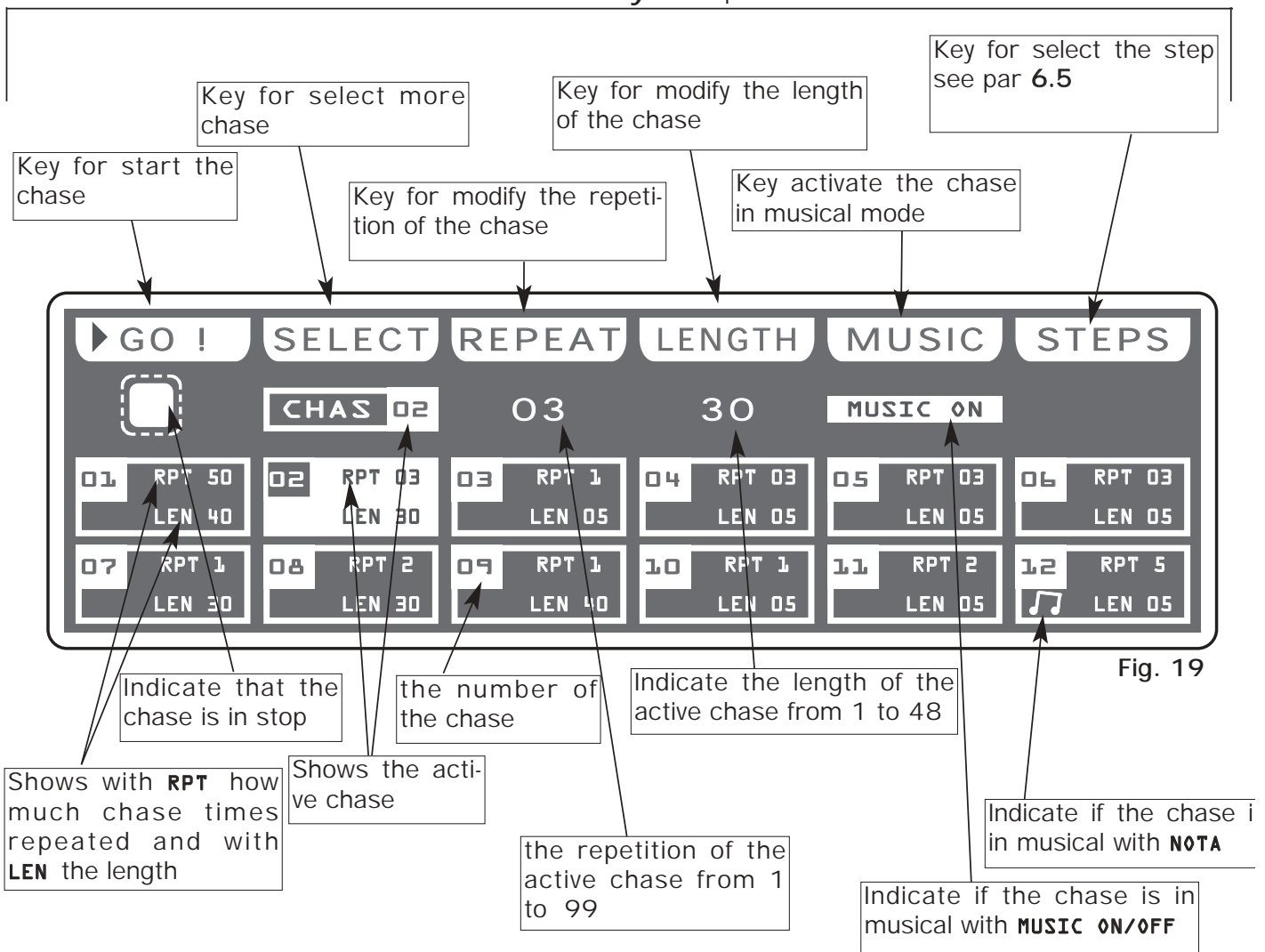

Fig. 19

In **EDIT CHASE** mode there are 6 **function keys** see (Fig. 19 par 6.1)

GO key:

Press this key to start the chase.

Note: Keep Master Dimmer Chase to the maximum see (par 6.12)

The key becomes **PAUSE** the display changes as shown in (Fig. 21 par 6.3)

PAUSE key:

Press this key to stop the chase in the current position, pressing the **GO** key it recovers from the same position.

SELECT key:

Pressing this key it is possible the multiple selection of the chases. The display changes as shown in (Fig. 19 par 6.3)

Press one of the 1÷12 keys to select the chase .

For successive chase s use the **PAGE** key.

REPEAT key:

Press this key to modify the number of repetitions of the chase , the value is in number from 1 to 99 use the faders under the **REPEAT** writing, or the encoder. For confirm the modify press the **OK** key, for get out of the function press the **ESC** key.

LENGTH key:

Press this key to set how many scenes of the chase will execute, the value is in number from 1 to 48 use the faders under the **LENGTH** writing, or the encoder. For confirm the modify press the **OK** key, for get out of the function press the **ESC** key.

MUSIC key:

Pressing this key, and activating **MUSIC ON**, the active chase will change the scenes to time of music, in the box of the chase and to the side at symbol play the display shows a note.

The internal music sensor has an automatic gain adjustment which allows to have a signal level good for the **Top 48** working.

The input music signal is a 0dB mono/stereo so it could be taken from sound sources like Mixer, CD, Dat etc.

STEPS keys:

Pressing this key you go in the step mode see par 6.5

THIS FUNCTION ALLOWS TO SELECT A SERIES OF CHASE

For activate the multiple selection of the chases you must press the **SELECT** key (Fig. 20).

The display changes as shown in (Fig. 21).



Fig. 20

Press one of the 1÷12 keys to select more chase.
For successive chases use the **PAGE** key.

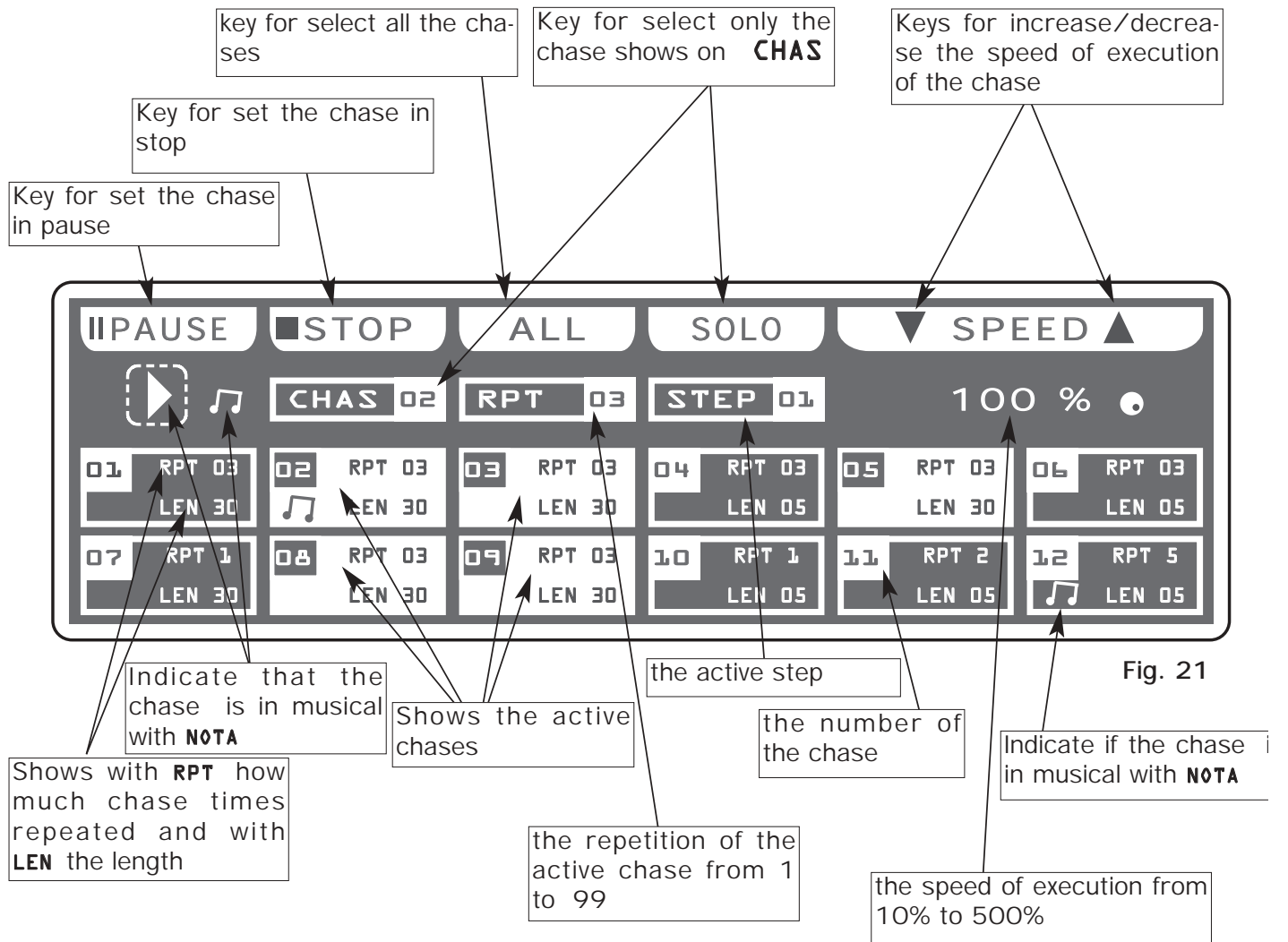

Fig. 21

In **CHASE** mode there are 6 **function keys** see (Fig. 21 par 6.3).

PAUSE key:

Press this key to stop the chase in the current position, pressing the **GO** key it recovers from the same position.

STOP key:

Press this key to stop the chase, pressing the **GO** key it start from the first step.

ALL key:

Press this key to select all the chase from 1 to 48.

SOLO key:

Press this key to select only the chase shown in the box **CHAS**, if we have selected with the **ALL** key all the **48** chase, and we wants to selectd only the chase (es. n° **02**), press twice the key **02** of chase selection. The chase box will indicate **CHAS 02** now the **SOLO** key unselect all the other chase, activating **SOLO** the **CHAS 02**

SPEED key:

Pressing one of these two keys will be increased/decreases the speed of execution of the chase the value is in percent and varied from 10% at 500%. To the value 100%. the speed of execution is that planned in the scenes.

THIS FUNCTION ALLOWS TO SEE ONE OF THE 48 STEPS OF THE ACTIVE CHASE, CHANGE THE PARAMETERS AND EDITING.

Press **STEPS** key to activate **STEPS** function (Fig. 22)

The display changes as shown in (Fig. 23)

The graphic display indicates the scene (**highlighted**) currently active (Fig. 23) if an empty step is selected, on the display appears "FREE STEPS".



Fig. 22

Press one of the 1÷12 keys to select the step.

Pushes it again, the step puts on out his end value.

For successive step use the **PAGE** key

Note: Keep Master Chase Faders to the maximum see (par 6.12)

Function Keys see par 6.6

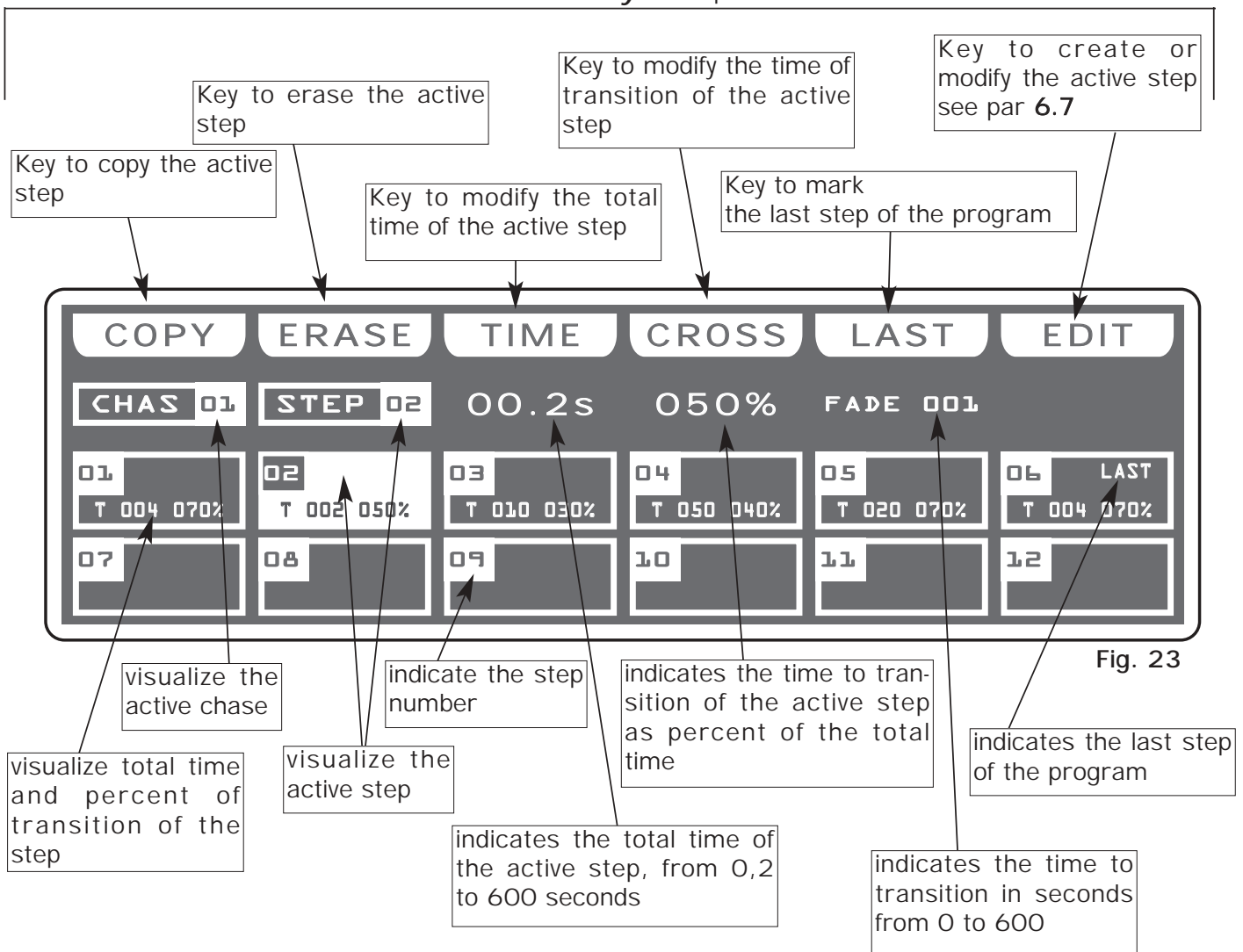

Fig. 23

In **STEP** mode there are 6 **function keys** see (Fig. 2 par 4.1).

COPY Key:

Pressing this key on the display shows "**SELECT DESTINATION SCENE,**" select through the 1÷12 keys the destination of the copy.

For the successive chases use **PAGE** key

Note: After have pressed **COPY** key, the same becomes **GRAB** key.

GRAB Key:

Press this key to store the step, you can then paste it in an empty step of the same chase or in a different chase. The key becomes **PASTE**.

PASTE Key:

Pressing this key the step previously stored could be pasted to an any empty step of any chase.

ERASE Key:

Pressing this key the active step will be erased, select through the 1÷12 keys (for the successive chases use **PAGE** key) the step that must be erased, then press the **ERASE** key.

The step will be erased in a permanent way, it is not possible recover it.

TIME Key:

Press this key to change the total time of the scene, the value is in seconds from 0,2 to 600, use the fader under the **TIME** writing, or the encoder. For confirm the modify press the **OK** key, for get out of the function press the **ESC** key.

CROSS Key:

Press this key to modify the time of transition of the scene, the value is express in percent from 0 to 100%, use the fader under the **CROSS** writing, or the encoder. For confirm the modify press the **OK** key, for get out of the function press the **ESC** key.

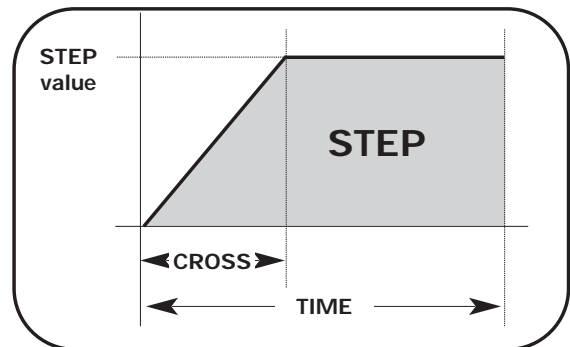

LAST Key:

Press this key to select the last step of the chase, select through the 1÷12 keys (for the successive chases use **PAGE** key) the step where you want to terminate the chase, then press the **LAST** key.

For the successive chases use **PAGE** key

Note: The last step of the chase will be stored automatically in **EDIT** mode.

EDIT Key:

Press this key to create/modify the active step see par. 6.7 **EDIT IN STEP mode**

THIS FUNCTION ALLOWS TO CREATE OR MODIFY ONE OF 48 STEP OF ACTIVE CHASE .

The graphic display indicates the step (**highlighted**) currently active (Fig. 23 par 6.5) for create/modify it press the **EDIT** key (Fig. 24).

The display changes as shown in (Fig. 25).



Fig. 24

Pressing one of the 1÷12 keys the correspondent channel go to the 0 value if it is high, to 255 value if it is low.

For successive channels use the **PAGE** key

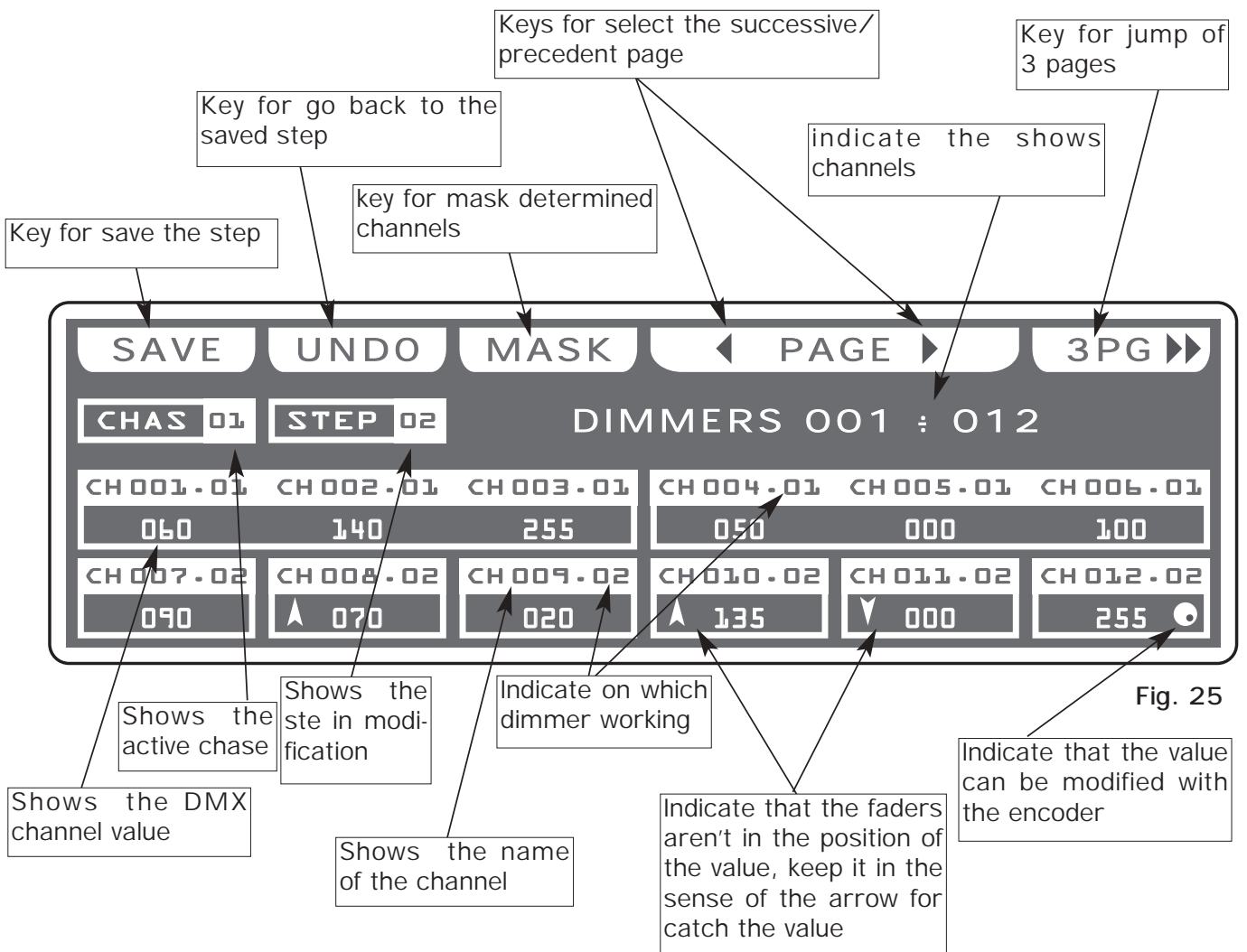

Fig. 25

In EDIT STEPS mode there are 6 function keys see (Fig. 6 par 4.5).

SAVE key:

Press this key to save the step

UNDO:

Pressing this key you go back to the saved step

MASK key:

Press this key to activate the mask function. see par 6.10

PAGE keys :

Press this keys to select the successive/precedent page

3PG keys:

Pressing this will jump of 3 pages in 3 pages.

6.9 CHANNELS ADJUSTMENT FADERS IN EDIT STEPS MODE

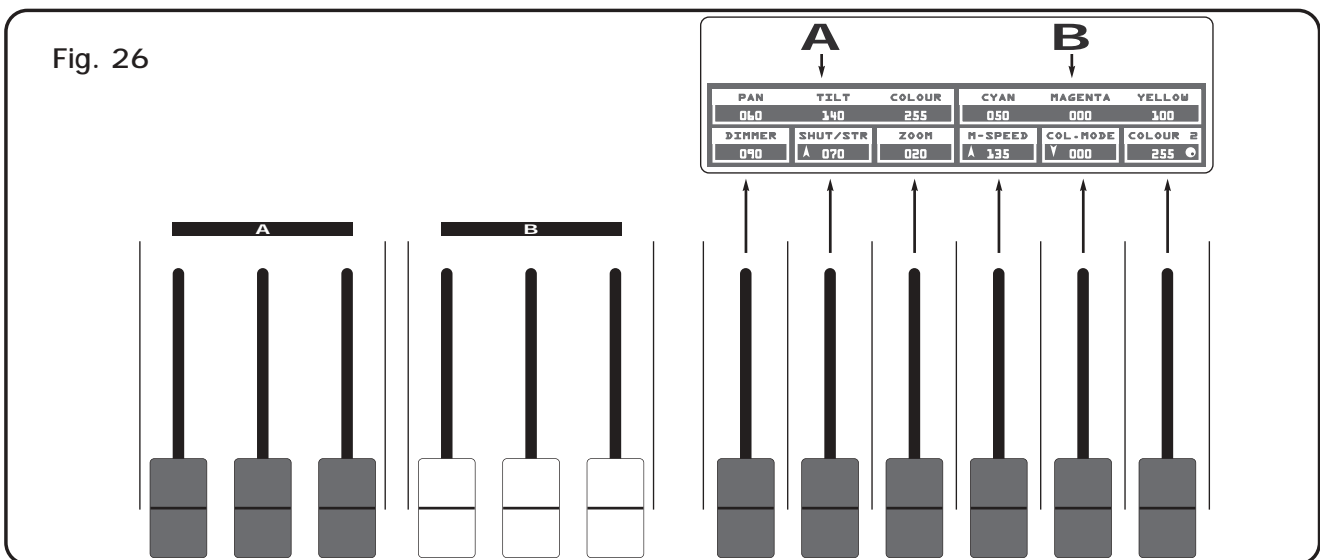

The 12 faders are used to adjust the channels value see (Fig. 7)

For modify the step , keep the faders to desired values.

Each time that changes page the faders remains inactive.

The arrow in the box ndicate that the fader aren't in the position of the value, keep it in the sense of the arrow for catch the value.

For an on-off chase type use the 1÷12 keys

For successive channels use the **PAGE** key

N.B. The 6 single boxes (under part of the display) do reference to the faders immediately under. The two boxes from 3 channels (above to the single) do reference respectively:

The left box at 3 faders "A"

The right box at 3 faders "B"

THIS FUNCTION ALLOWS TO MASK THE DIMMER CHANNELS IN A DETERMINED STEP.

Pressing **MASK** key the **MASK** function is activated (Fig. 27)

The display changes as shown in (Fig. 28)

The graphic display indicates the channels masked with the symbol"===" (Fig. 28)

The operator in this case masks the 2,4,5 and 6 channels. When you recall the step The masked channels stay to the value planned in precedence.



Press one of the 1 ÷ 12 keys to masks the correspondent channels. For successive channels use the **PAGE** key

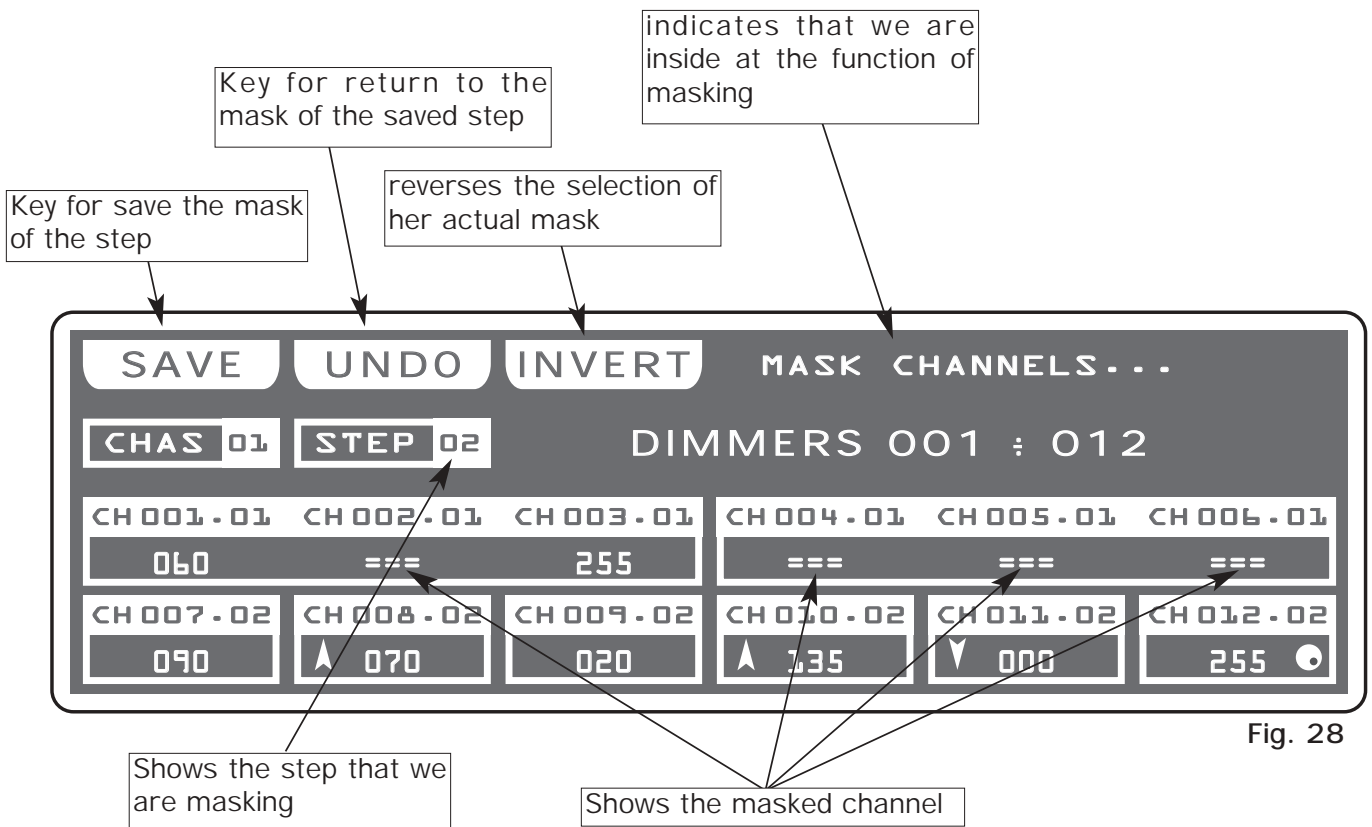

Fig. 28

INVERT key:

Press this key to revers the selection of the actual mask, in the case of the (Fig. 9) the 2,4,5 and 6 channels becomes modifiable, while the others comes masked.

TOP 48 IS ENDOWED WITH A GENERAL CONTROL LEVEL OUTPUT, OF ALL "DIMMER" CHANNELS OF THE INTELLIGENT UNITS.

The Master Dimmer fader (Fig. 29) allows to adjust the bright general intensity of the intelligent units, **(only if the connected unities have the dimmer channel)**.

Keep the fader always to the maximum 100%, keep to 0 value only for create a blackout.

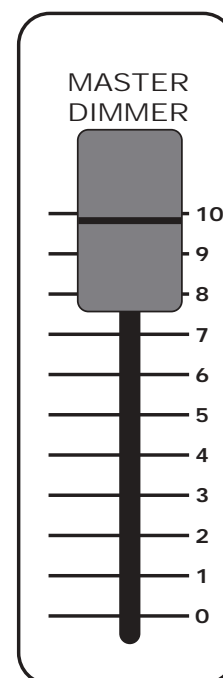

Fig. 29

TOP 48 IS ENDOWED WITH A GENERAL CONTROL LEVEL OUTPUT, OF DIMMER CLASSIC CHANNELS.

The Master Chase fader (Fig. 30) allows to adjust the bright general intensity of the chase and relative step.

For have the bright intensity of chase/step at 100% keep the fader to the maximum, keep to 0 value only for create a blackout.

The Master Chase fader could be used also for pu in output a step like scene, see (par 6.5).

Keep the fader to 0 value, select through the 1÷12 keys the step we want on output, then keep the fader to desired value.

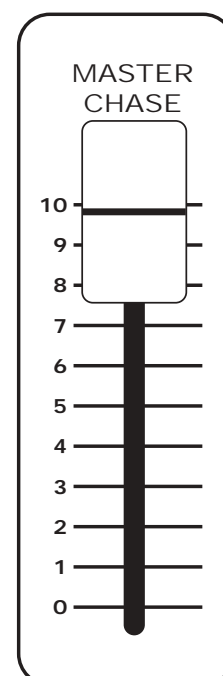

Fig. 30

THIS FUNCTION ALLOWS TO ACTIVATE AN EFFECT GENERATOR AND MODIFY THE PARAMETERS.

USING THIS MODE OF OPERATION IT IS POSSIBLE CREATE ANIMATIONS OF NOTABLE EFFECT WITH AN ONLY COMMAND.

Press EFFECT key to activate *EFFECT* function (Fig. 18)

The EFFECT key led will light up to indicate the activation of this function, and the display changes as shown in (Fig. 31).

The graphic display indicates the effect (**highlighted**) currently active attivo (Fig. 32).

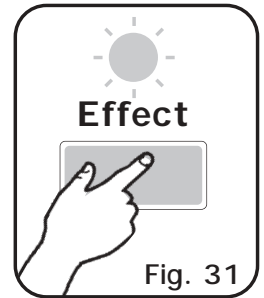

Press one of the 1÷12 keys to select the effect.
For successive effect use the PAGE key

Function Keys see par 7.2

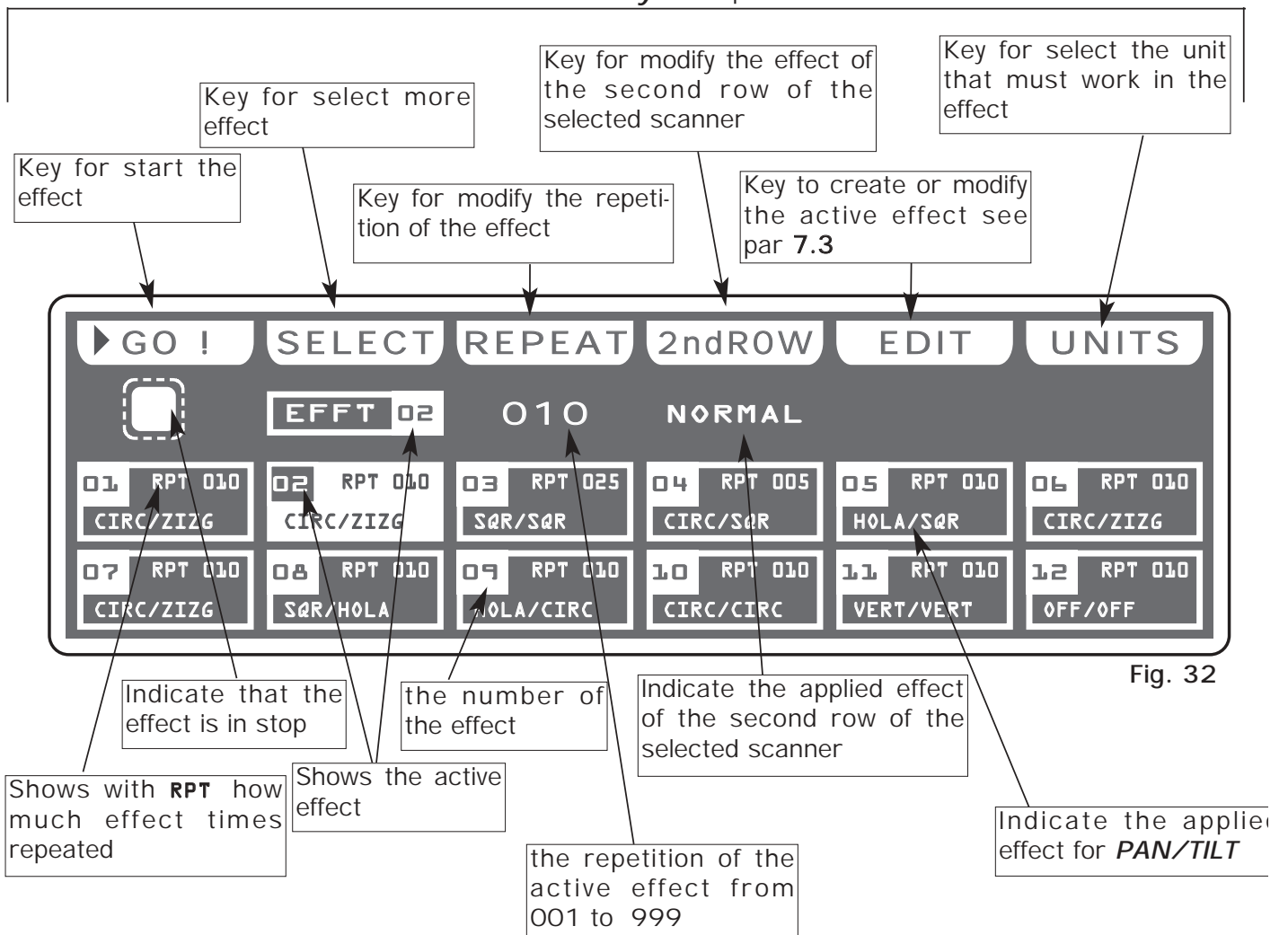

Fig. 32

In **EFFECT** mode there are 6 **function keys** see (Fig. 32 par 7.1)

GO key:

Press this key to start the effect.

The key becomes **PAUSE** the display changes as shown in (Fig. 34 par 7.3)

PAUSE key:

Press this key to stop the effect in the current position, pressing the **GO** key it recovers from the same position.

SELECT key:

Pressing this key it is possible the multiple selection of the effect. The display changes as shown in (Fig. 34) see par 7.3

Press one of the 1÷12 keys to select more effect .

For successive effects use the **PAGE** key.

REPEAT key:

Press this key to modify the number of repetitions of the effect, the value is in number from 001 to 999 use the faders under the **REPEAT** writing, or the encoder. For confirm the modify press the **OK** key, for get out of the function press the **ESC** key.

2ndROW key:

For faced or disposed on more rows scanners.

Press this key to modify the effect of the second half of the selected scanner.

The modalities are:

NORMAL: No modification.

NO DELAY: Keep the first scanner in phase, if there are **DELAY**.

INV PAN: Reverses the movement of the mirror X axis

INV TILT: Reverses the movement of the mirror Y axis

INV ROT: Reverses the direction of the shape execution.

Use the fader under **2ndROW** write or the encoder. For confirm the modify press the **OK** key, for get out of the function press the **ESC** key.

EDIT Key:

Press this key to create/modify the active effect, see par 7.5.

UNITS keys:

Press this key to set what unit will be active in the effect.

For successive units use the **PAGE** key.

THIS FUNCTION ALLOWS TO SELECT A RANGE OF EFFECTS EXECUTABLE IN SUCCESSION

For activate the multiple selection of the effects you must press the **SELECT** key (Fig. 33).

The display changes as shown in (Fig. 34).

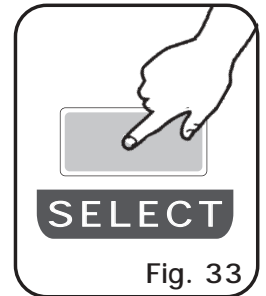

Fig. 33

Press one of the 1 ÷ 12 keys to select more effect.
For successive effects use the **PAGE** key.

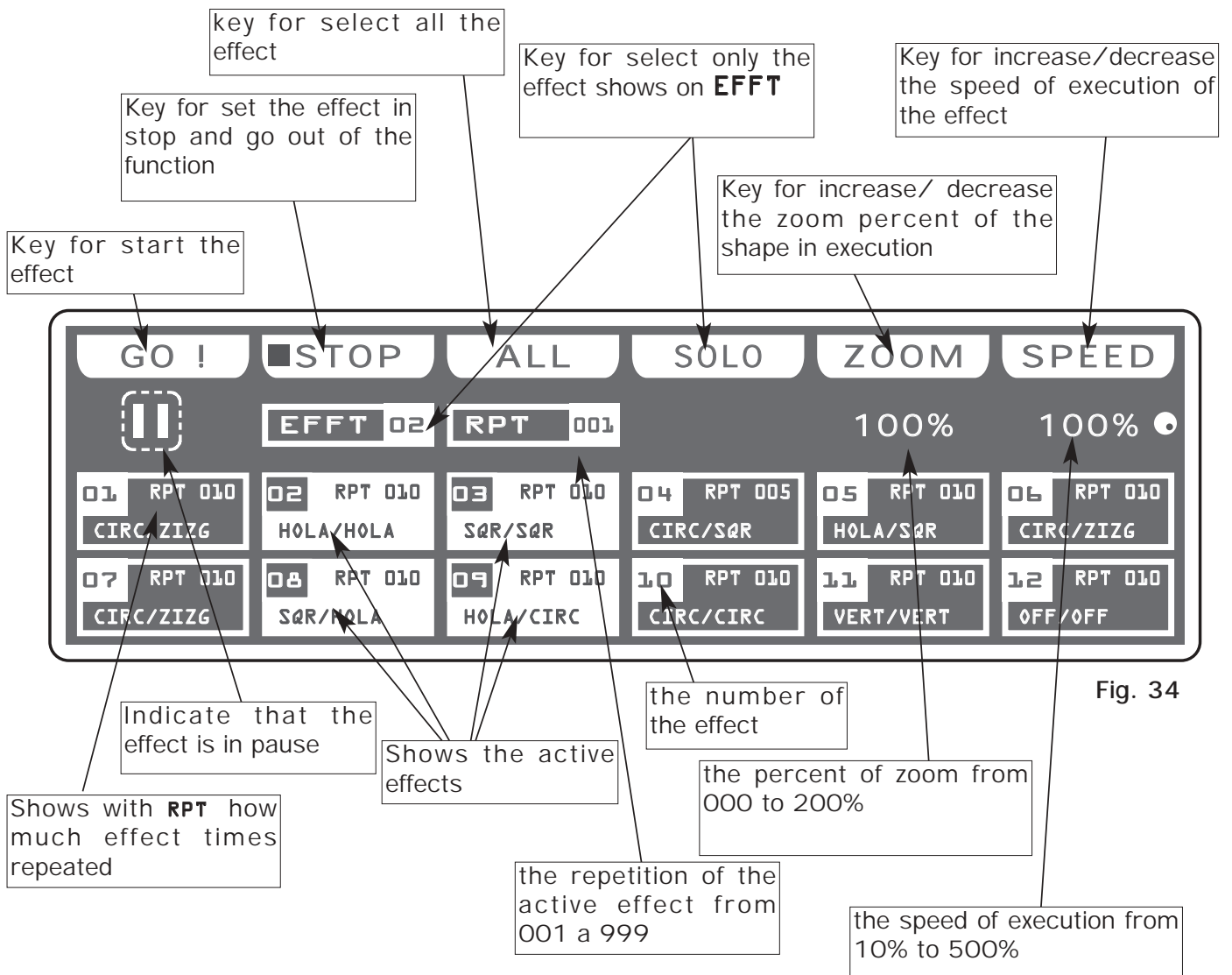

Fig. 34

In **EFFECT** mode there are 6 **function keys** see (Fig. 34 par 7.3).

GO key:

Press this key to start the effect.

The key becomes **PAUSE**

PAUSE key:

Press this key to stop the effect in the current position, pressing the **GO** key it recovers from the same position.

STOP key:

Press this key to stop the effect, return to the **EFFECT** function see (par 7.1), pressing the **GO** key it start again.

ALL key:

Press this key to select all the effect from 1 to 48.

SOLO key:

Press this key to select only the effect shown in the box **EFFT**, if we have selected with the **ALL** key all the **48** effect, and we wants to selectd only the effect (es. n° **02**), press twice the key **02** of effect selection. The effect box will indicate **EFFT 02** now the **SOLO** key unselect all the other chase, activating **SOLO** the **EFFT 02**

ZOOM key:

Press this key for increase/decrease the percent of zoom of the shape in execution, the value is express in percent and varied from 000% to 200%. To 000 value the shape stop.

SPEED key:

Press this key to increase/decrease the speed of execution of the chase, the value is in percent and varied from 10% at 500%.

THIS FUNCTION ALLOWS TO EDIT ONE OF 48 EFFECTS

The graphic display indicates the effect (**highlighted**) currently active (Fig. 32 par 7.1) for create/modify it press the **EDIT** key (Fig. 35).

The display changes as shown in (Fig. 36).

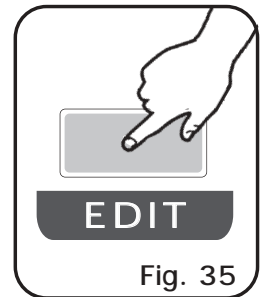

Press one of the 1÷6 keys to select the effect on the **PAN** channel
Press one of the 7÷12 keys to select the effect on the **TILT** channel

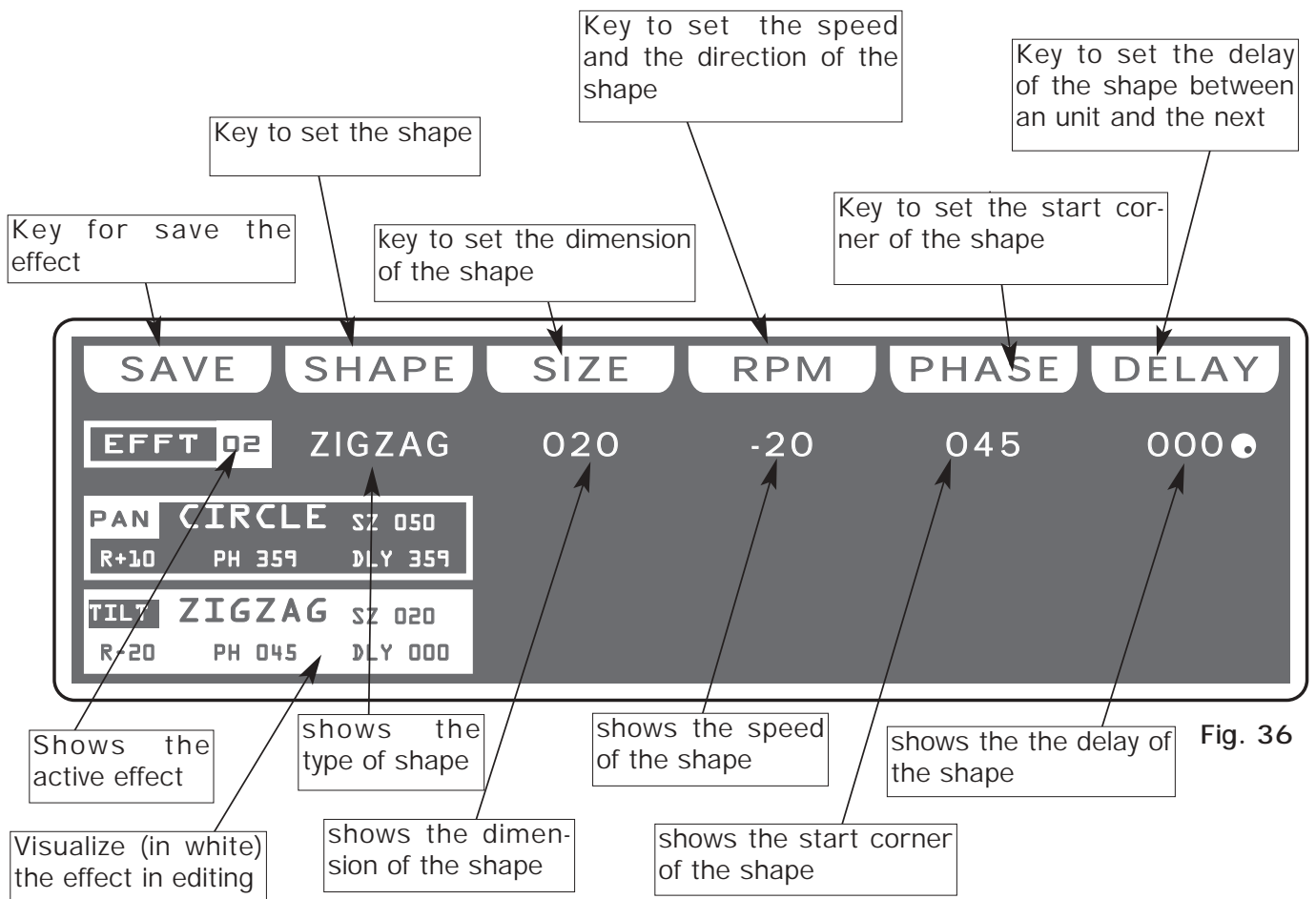

In **EDIT EFFECT** mode there are 6 **function keys** see (Fig. 36 par 7.5).

SAVE key:

Press this key to save the effect

SHAPE key:

Press this key for select the shapes, that are:

Circle, Hola, Ladder, Square, Vertex, and Zigzag.

The parameters that the operator could change correspond to:

SIZE key:

Press this key to change the size of the shape (from 1 to 128)

RPM key:

Press this key to change the speed and direction of the shape (from -60 to +60)

PHASE key:

Press this key to change the the start corner of the shape (from 0 to 359).

DELAY key:

Press this key to change the delay of the shape between an unit and the next (from 0 to 359).

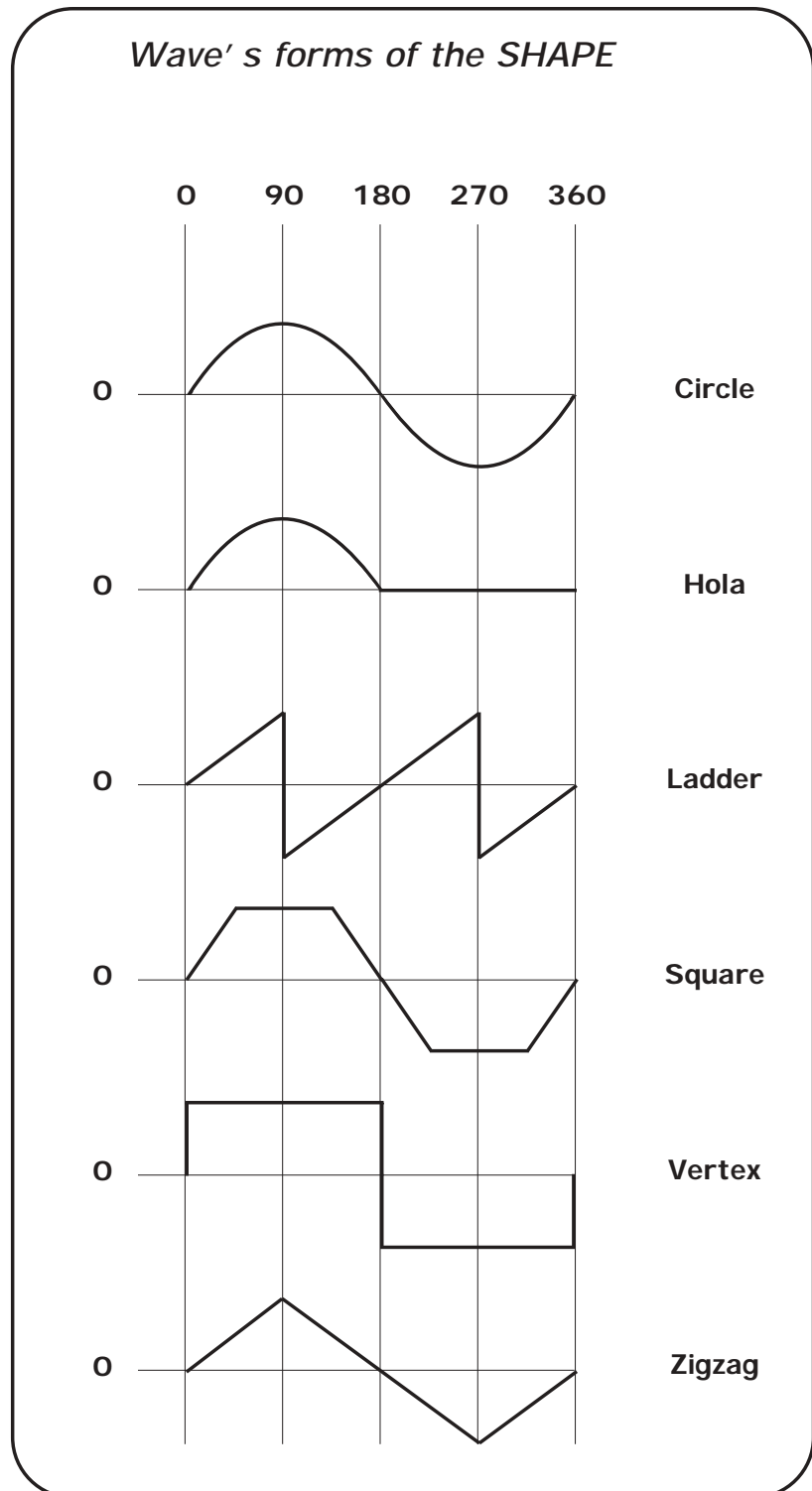

THIS FUNCTION ALLOWS TO ACTIVATE A SHOW AND MODIFY THE PARAMETERS

THIS OPERATIVE MODE, ALLOWS TO PERFORM, AT THE SAME TIME, UP TO 4 SEQUENCES OF PROGRAM + 4 SEQUENCES OF CHASE + 4 SEQUENCES OF EFFECT

Press **SHOW** key to activate **SHOW** function (Fig. 37)

The **SHOW** key led will light up to indicate the activation of this function, and the display changes as shown in (Fig. 38).

The graphic display indicates the show (**highlighted**) currently active (Fig. 38).

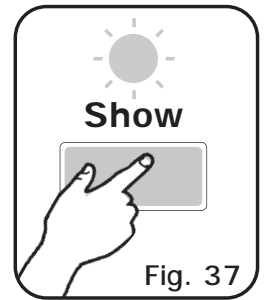

Function Keys see par 8.2

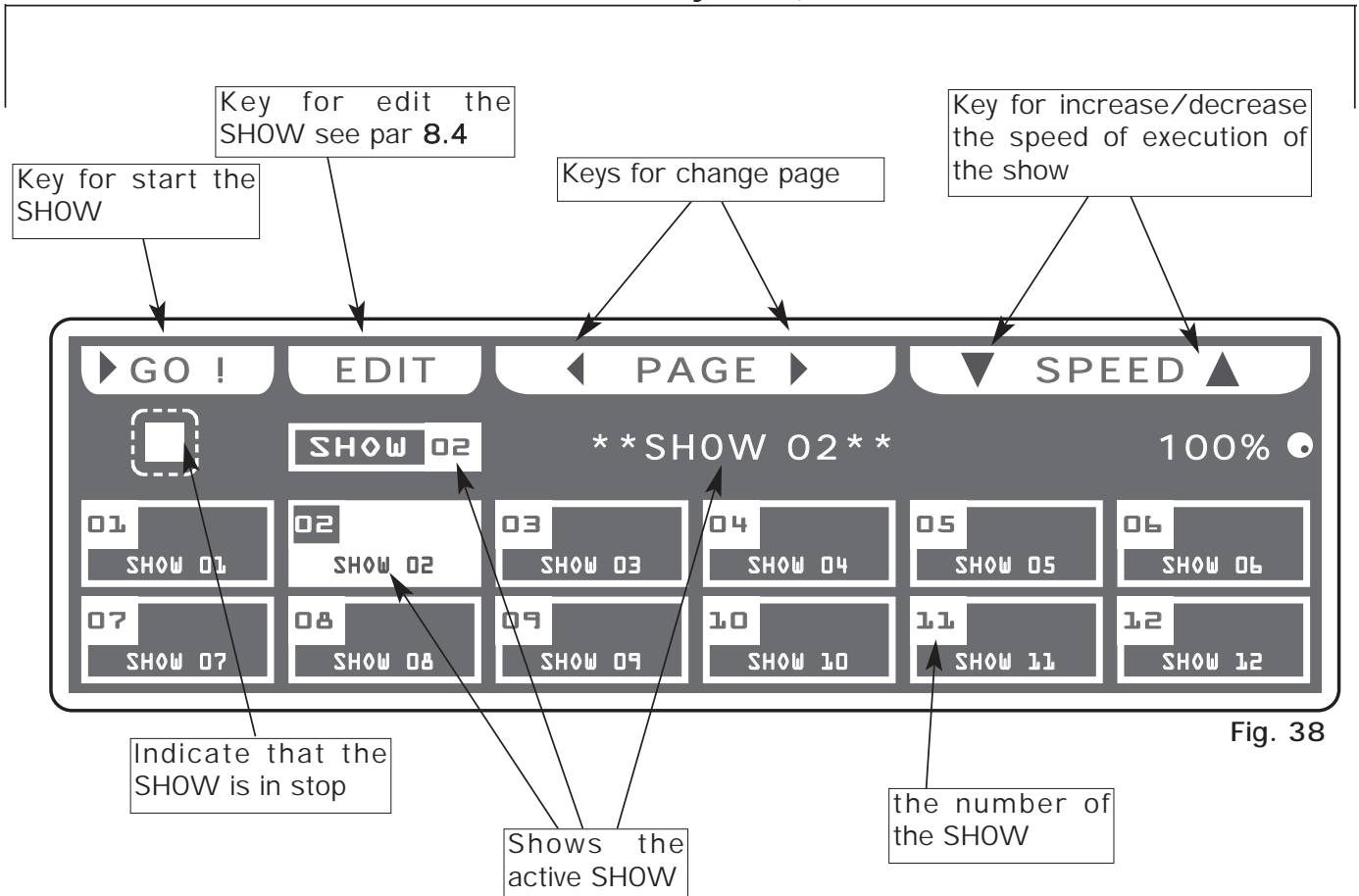

In **SHOW** mode there are 6 **function keys** see (Fig. 38 par 8.1)

GO key:

Press this key to start the show.

The key becomes **PAUSE** the display changes as shown in (Fig. 40 par 8.3)

PAUSE key:

Press this key to stop the show in the current position, pressing the **GO** key it recovers from the same position.

EDIT key:

It allows to modify the parameters of the show see par 8.4.

PAGE key:

Pressing one of these two keys you go to the following /next page

SPEED key:

Pressing one of these two keys you increase/decrease the speed of the show the value is in percent and varied from 10% to 500%.

To the 100% value the speed is the original.

THIS FUNCTION EXECUTES AND VISUALIZES THE STATE OF THE SHOW

The graphic display indicates the step (**highlighted**) currently active(Fig. 38 par 8.1) for execute it press the **GO!** key (Fig. 39).

The display changes as shown in (Fig. 40).



Press one of the 1 ÷ 12 keys to select the show.
For successive show use the **PAGE** key

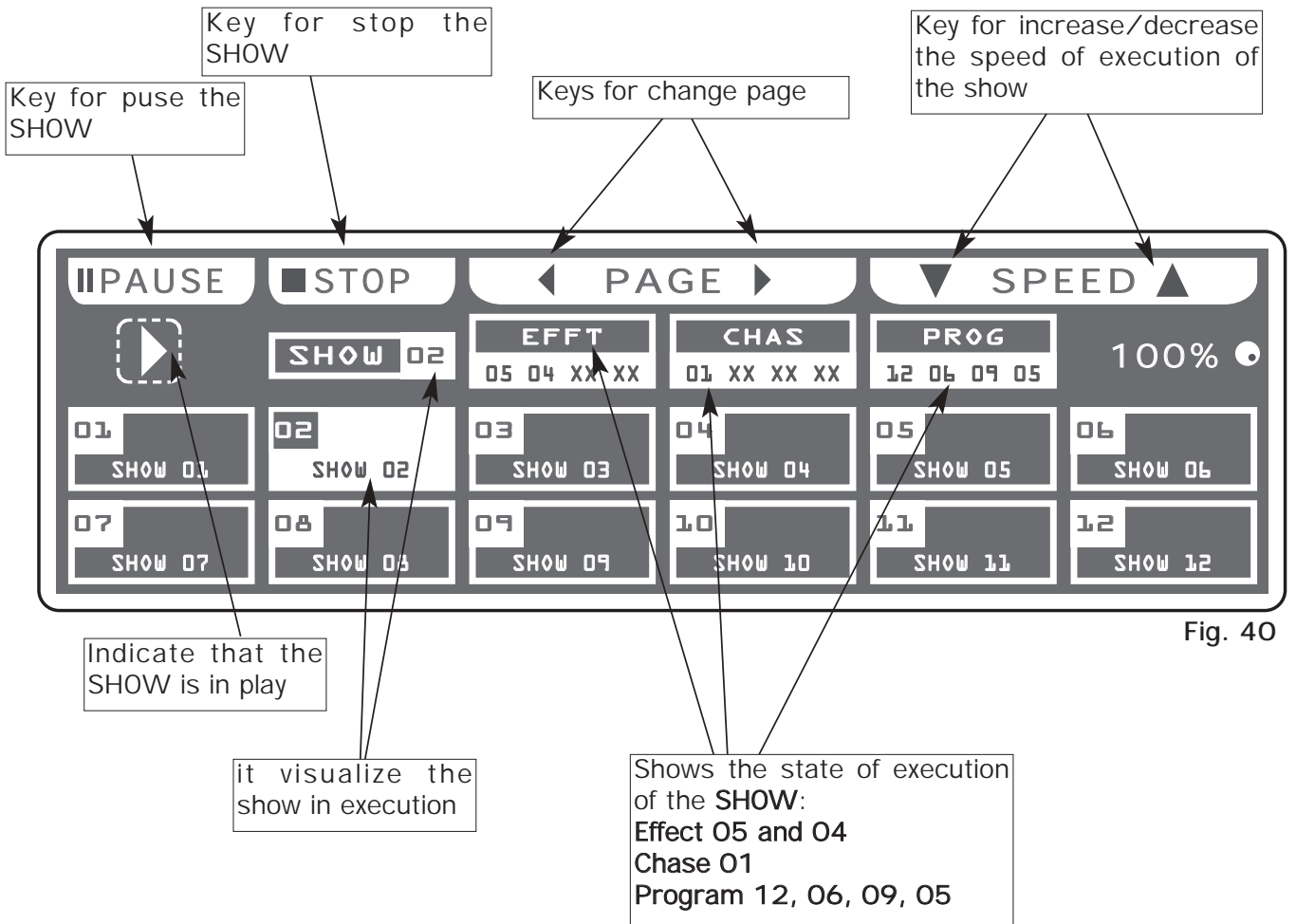

Fig. 40

THIS FUNCTION ALLOWS TO CREATE OR MODIFY ONE OF 96 SHOW

The graphic display indicates the show (**highlighted**) currently active (Fig. 38 par 8.1) for create/modify it press the **EDIT** key **EDIT** (Fig. 41).

The display changes as shown in (Fig. 42).



Fig. 41

Press one of the 1÷12 keys to select one of 4 effect/chase/program processor.

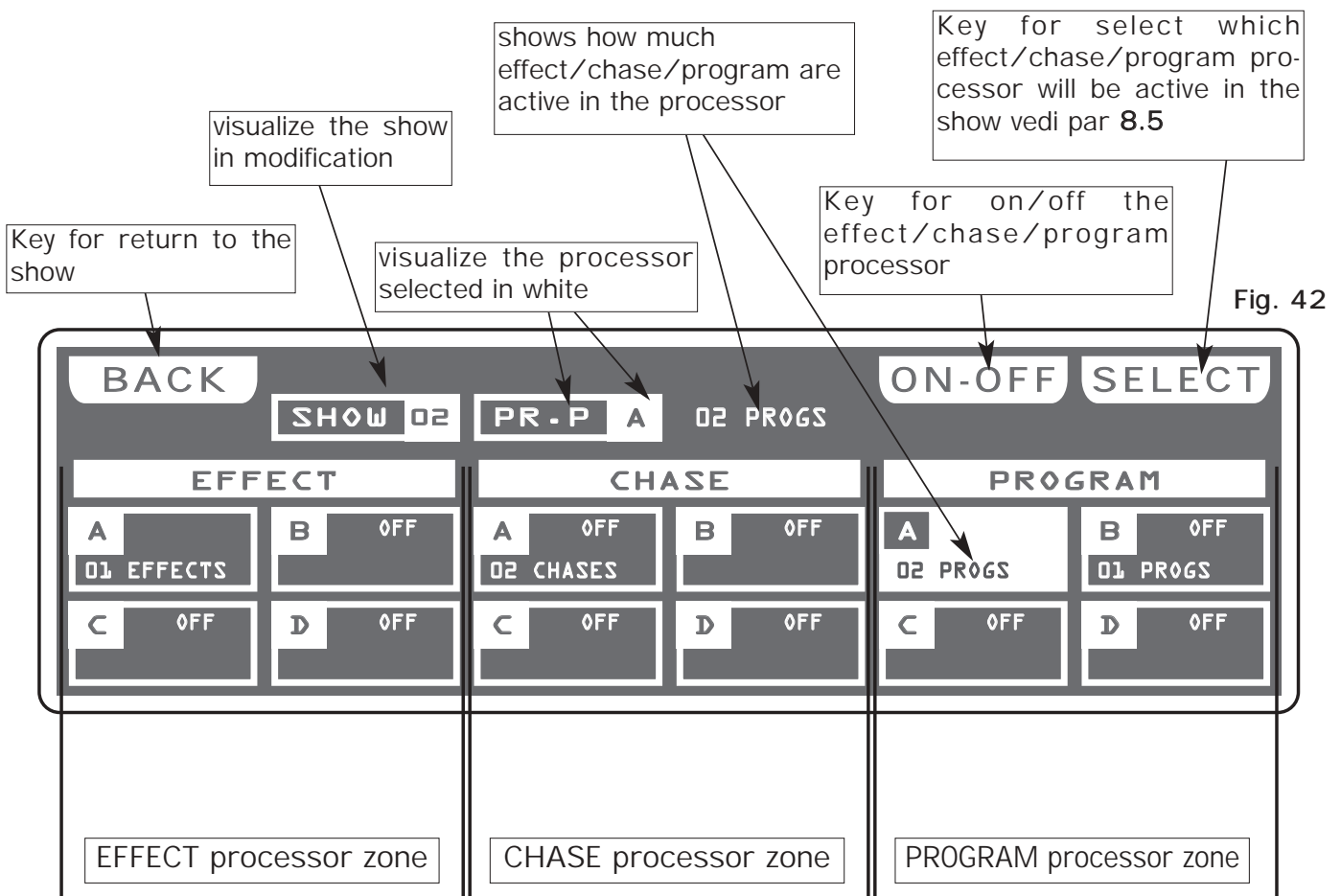

THIS FUNCTION ALLOWS TO SELECT A SERIES OF EFFECT/CHASE/PROGRAMS THAT COMPOSE THE SHOW

The graphic display indicates the effect/chase/program processor (**highlighted**) currently active (Fig. 42 par 8.4) to select the effect/program/chase active in the varieties processor press the **SELECT** key (Fig. 43).

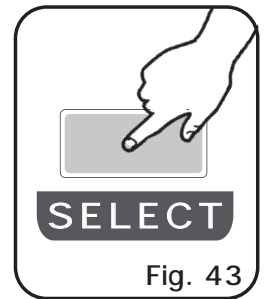

Fig. 43

The display changes as shown in (Fig. 44a/44b/44c).

Press one of the 1÷12 keys to select more effect/program/chase. For successive effect/program/chase use the **PAGE** key.

EFFECT SELECTION

Fig. 44a

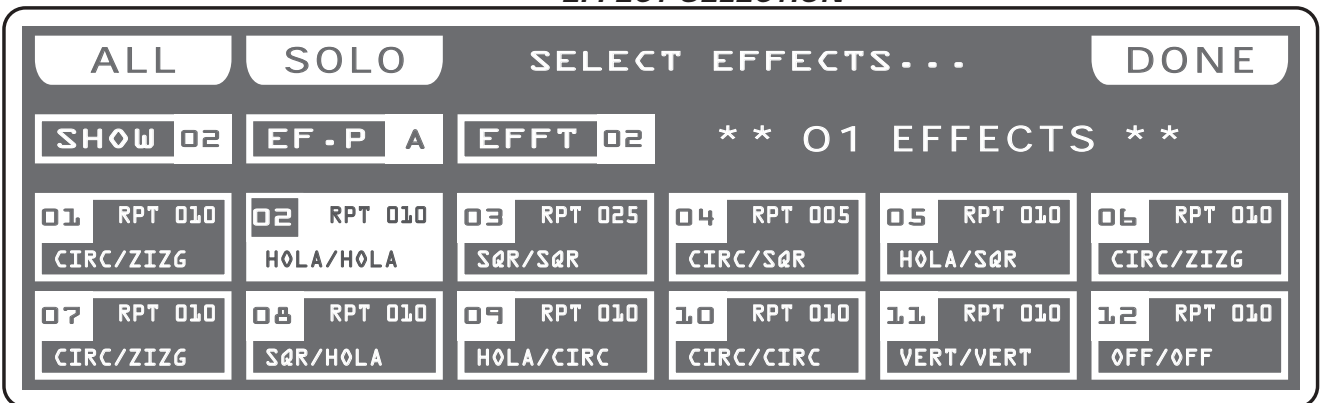

CHASE SELECTION

Fig. 44b

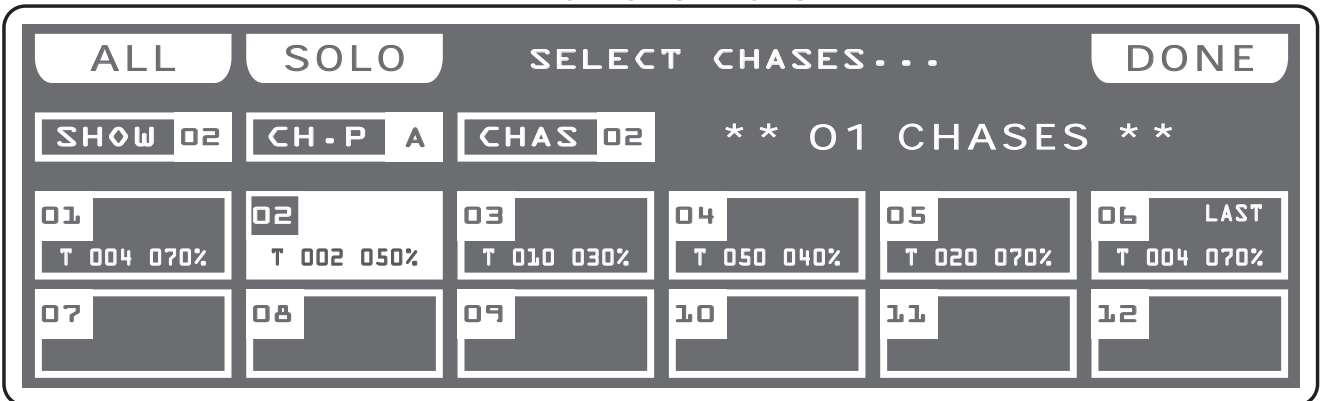

PROGRAM SELECTION

Fig. 44c

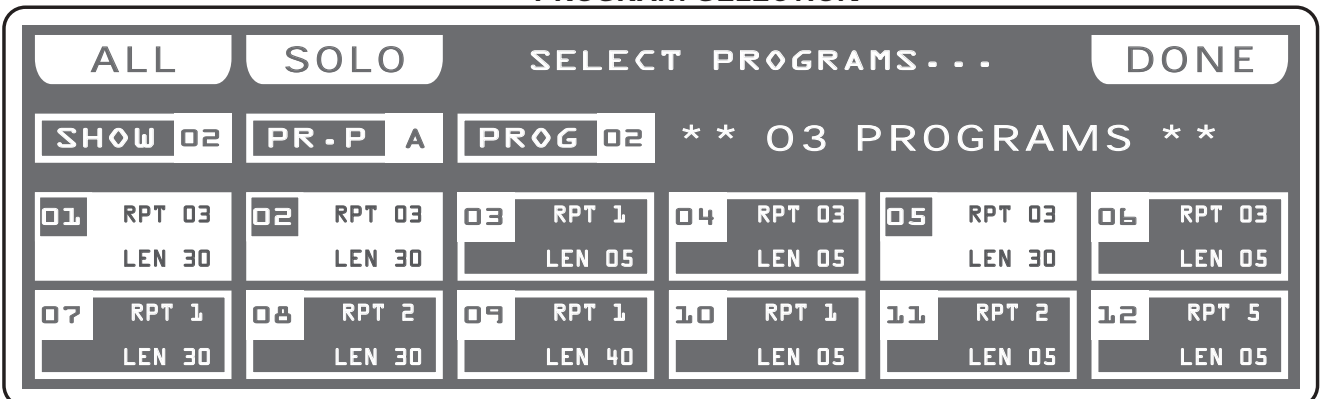

A **Program** is a range of scenes (max 48) performed in succession. To create/modify a program follow all steps listed below:

- 1) If Top 48 is switched off, switch it on pressing **POWER** key.
- 2) Press **Program** key to activate the **PROGRAM** function.
(the **Program** led key will light up).
- 3) Press 1÷12 keys to select only the program that you want to modify.
(only one program **highlighted**).
For successive program use the **PAGE** key
- 4) Press the **UNITS** key and select through the 1÷12 keys the units that must work in the program. Confirm with the **DONE** key
- 5) Press **Scene** key to activate the **SCENE** function.
(the **Scene** led key will light up).
- 6) Press one of the 1÷12 keys to select the scene that we want to create/modify.
For successive scenes use the **PAGE** key
- 7) Press the **EDIT** key to create/modify the selected scene.
- 8) Modify the position with the joystick and the sets of the channels with the relative faders, press **UNIT** key for next/precedent unit.
- 9) When the scene has been completed, it can be stored through the **SAVE** key.
- 11) Now Top 48 is in the next scene repeat again the 7 and 8 steps.
- 12) When the creation of the scenes has been finished press **Program** key to come back to the **PROGRAM** function.
(the **Program** led key will light up).
- 13) Finally you must press the **GO** key to execute the program.

The program is complete; to create/modify others repeat again all the above steps.

A **Chase** is a play of lights, it is a sequence of steps (from 1 to 48 max). To create/modify a program follow all steps listed below:

- 1) If Top 48 is switched off, switch it on pressing **POWER** key.
- 2) Press **Chase** key to activate the **CHASE** function.
(the **Chase** led key will light up).
- 3) Press 1÷12 keys to select only the chase that you want to modify.
(only one chase **highlighted**).
For successive chase use the **PAGE** key
- 4) Press **STEPS** key to activate the **STEPS** function
- 5) Press one of the 1÷12 keys to select the step that we want to create/modify.
For successive steps use the **PAGE** key
- 7 Press the **EDIT** key to create/modify the selected step.
- 9) Modify the value of the channels through the 12 relative faders or the 1÷12 keys.
For next channels use the **PAGE** key
- 10) When the step is completed it can be stored through the **SAVE** key.
- 11) Now Top 48 is again in the **STEPS** function in order that you can select another step or copy the step already done in another one.
- 12) When the creation of the steps has been finished press **Chase** key to come back to the **CHASE** function.
(the **Chase** led key will light up).
- 13) Finally you must press the **GO** key to execute the chase.

The chase is complete; to create/modify others repeat again all the above steps.

Top 48 is endowed with pre-programmed plays movement, (modifiable) dedicated to the scanner and moving-head.

With this function it's possible to create animations of notable effect.

The available plays are:

Circle, Hola, Ladder, Square, Vertex, and Zigzag.

The parameters that the operator could vary correspond to:

SHAPE: Shape

SIZE: Dimension of the shape (from 1 to 128)

RPM: Speed and direction of the shape (from -60 to +60)

PHASE: Corner of departure of the shape (from 0 to 359).

DELAY: Delay of execution of the shape between an unit and the next (from 0 to 359).

The parameters are independent for **PAN** and **TILT**, it is possible an infinity of combinations.

- 1) If Top 48 is switched off, switch it on pressing **POWER** key.
- 2) Press **Effect** key to activate the **EFFECT GENERATOR** function.
(the **Effect** led key will light up).
- 3) Press one of the 1÷12 keys to select the effect that we want to create/modify.
For successive effect use the **PAGE** key
- 4) Press the **EDIT** key to create/modify the selected effect.
- 5) Press one of the 1÷6 keys to select the effect on the **PAN** channel
Press one of the 7÷12 keys to select the effect on the **TILT** channel
- 6) Modify the parameters of the effect through the **SHAPE** , **SIZE**, **RPM**,
PHASE and **DELAY** keys.
- 7) Once modified the parameters, we can store the modifications through
the **SAVE** key.
- 8) Now Top 48 is again in the **EFFECT** function.
- 9) Press the **UNITS** key to check which unit must perform the effect.
- 10) Finally you must press the **GO** key to execute the effect.

The effect is complete; to create/modify others repeat again all the above steps.

This operative mode, allows to perform, at the same time, up to 4 sequences of program + 4 sequences of chase + 4 sequences of effect

- 1) If Top 48 is switched off, switch it on pressing **POWER** key.
- 2) Making sure of have program, chase ed effect (see par 9.1/9.2/9.3)
- 3) Press **Show** key to activate the **SHOW** function.
(the **Show** led key will light up).
- 4) Press 1÷12 keys to select only the show that you want to modify.
(only one show **highlighted**).
For successive show use the **PAGE** key
- 5) Press the **EDIT** key to create/modify the selected show.
- 6) Select through the 1÷12 keys the effett/chase/program processor that we want to configure.
- 7 Press the **SELECT** key for select which effett/chase/program that must work in the processor.
- 8) Press the **Done** key to confirm the selection
- 9) Through the **On/Off** key switch it **on-off** the boxes **A,B,C,D** of processor.
- 10) When the modify is complete, we can return in the **SHOW** function through the **Back** or **Esc** key.
- 11) Now Top 48 is again in the **SHOW** function in order that you can select another one
- 13) Finally you must press the **GO** key to execute the show.

The show is complete; to create/modify others repeat again all the above steps.

THIS FUNCTION ACTIVATES SOME SPECIAL FUNCTIONS FOR THE CONTROL OF THE UNIT AND THE SETTING OF THE CONTROLLER.

Press **Menu** key to activate *MENU* function. (Fig. 45)

The display changes as shown in (Fig. 46)

As soon as this function is activated, the display shows the first function available..

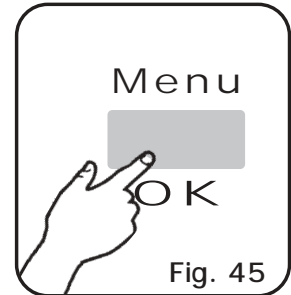
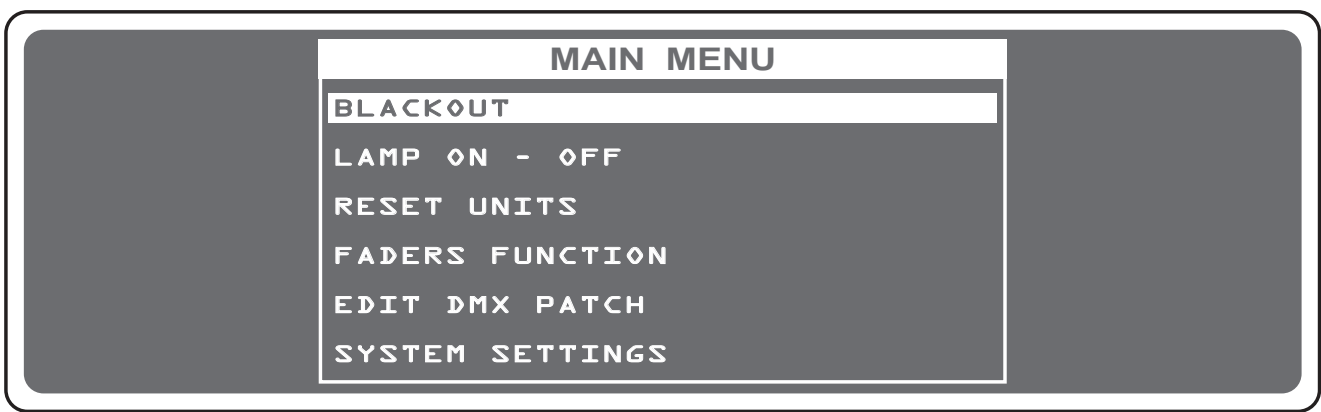

Fig. 45

Through the encoder it is possible select the *MENU* functions available. To activate the selected function press the same (OK) key.

Fig. 46



10.2 MENU: BLACKOUT

 AVAILABLE ONLY AFTER THE ACTIVATION OF THE **MENU** FUNCTIONS (v.par.10.1)

This function allows to black-out all the unit connected.

Press *DONE* or *ESC* key to start again the normal working.

The display changes as shown in (Fig. 46).

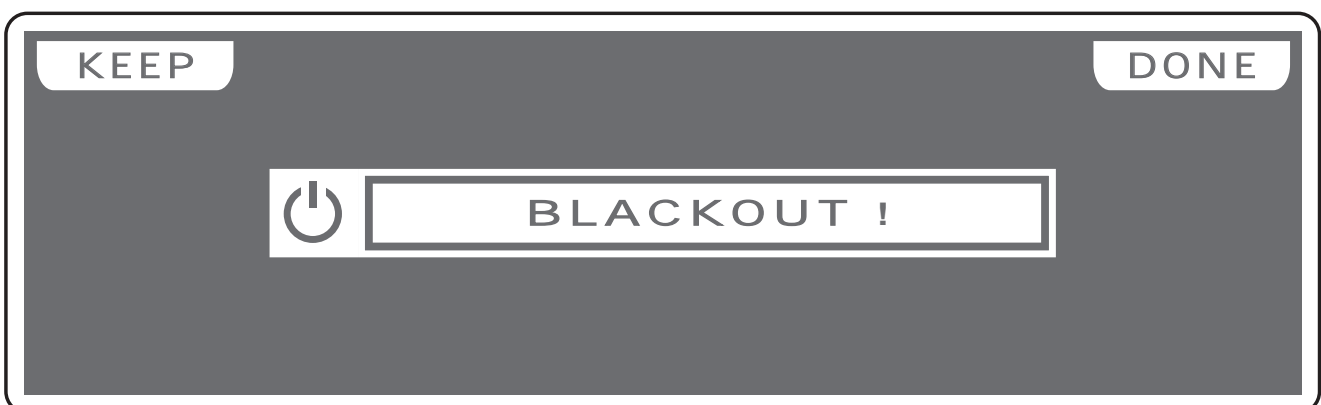

Pressing the **KEEP** key the Blackout comes kept up to when you call a program or a scene.

Fig. 46

AVAILABLE ONLY AFTER THE ACTIVATION OF THE MENU FUNCTIONS (v.par.10.1)

ALLOWS TO TURN ON / TURN OFF THE LAMP OF ONE OR MORE UNIT.
(only if the selected unit are predisposed for this function).

NOTE: If the lamp is "discharge" type and it is still hot, before its lighting you will need to wait that it gets cold.

The display changes as shown in (Fig. 47).

At the activation of the function the units are all selected.

Press one of the 1÷12 keys to select the unit.

For successive unit use the **PAGE** key

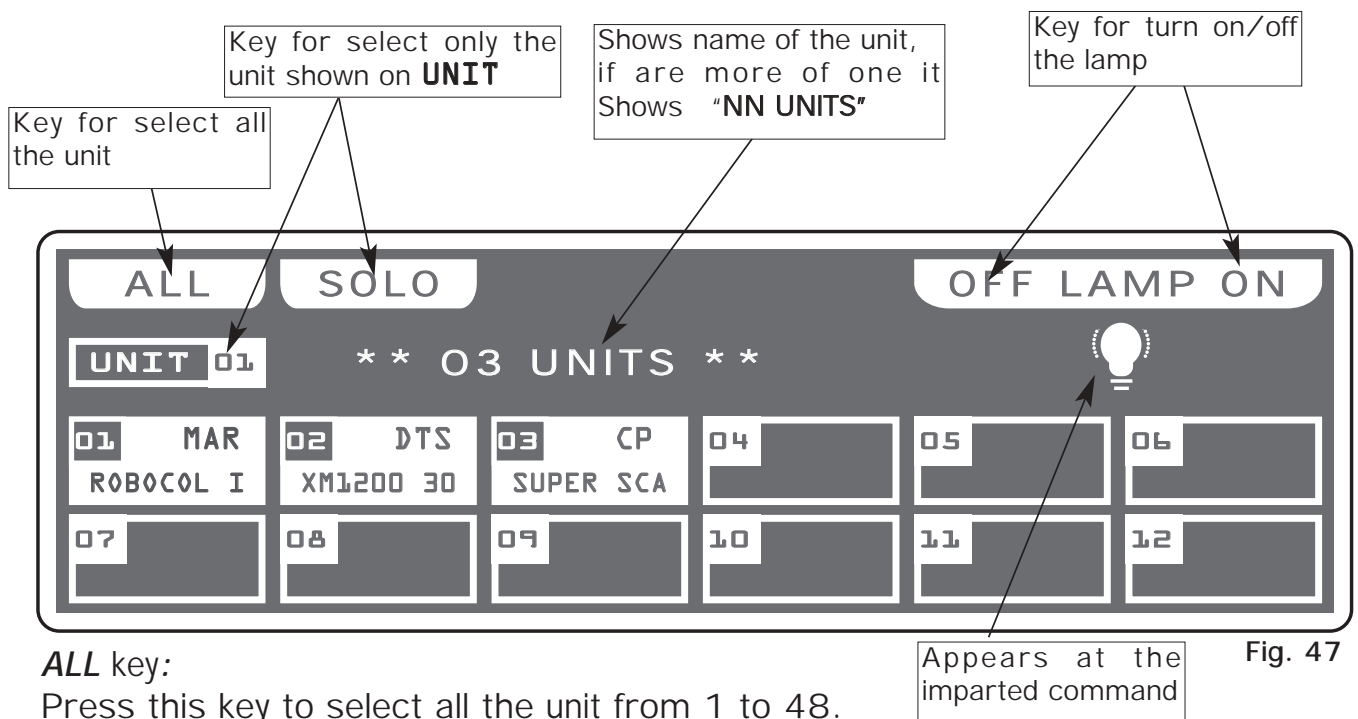

ALL key:

Press this key to select all the unit from 1 to 48.

SOLO key:

Press this key to select only the unit shown in the box **UNIT**, if we have selected with the **ALL** key all the **48** unit, and we want to select only the unit (es. n° **02**), press twice the key **02** of unit selection. The unit box will indicate **UNIT 02** now the **SOLO** key unselect all the other unit, activating **SOLO** the **UNIT 02**

OFF - ON keys:

Pressing one of these two keys will be turn on/turn off the lamp of the selected unit. For get out of the function press the **ESC** key.

AVAILABLE ONLY AFTER THE ACTIVATION OF THE MENU FUNCTIONS (v.par.10.1)

ALLOWS TO RESET ONE OR MORE UNIT.

(only if the selected unit are predisposed for this function).

This function must be performed when the unit lose synchronization or they don't perform the commands of the controller in a correct way.

The display changes as shown in (Fig. 48).

At the activation of the function the units are all selected.

Press one of the 1÷12 keys to select the unit.

For successive unit use the **PAGE** key

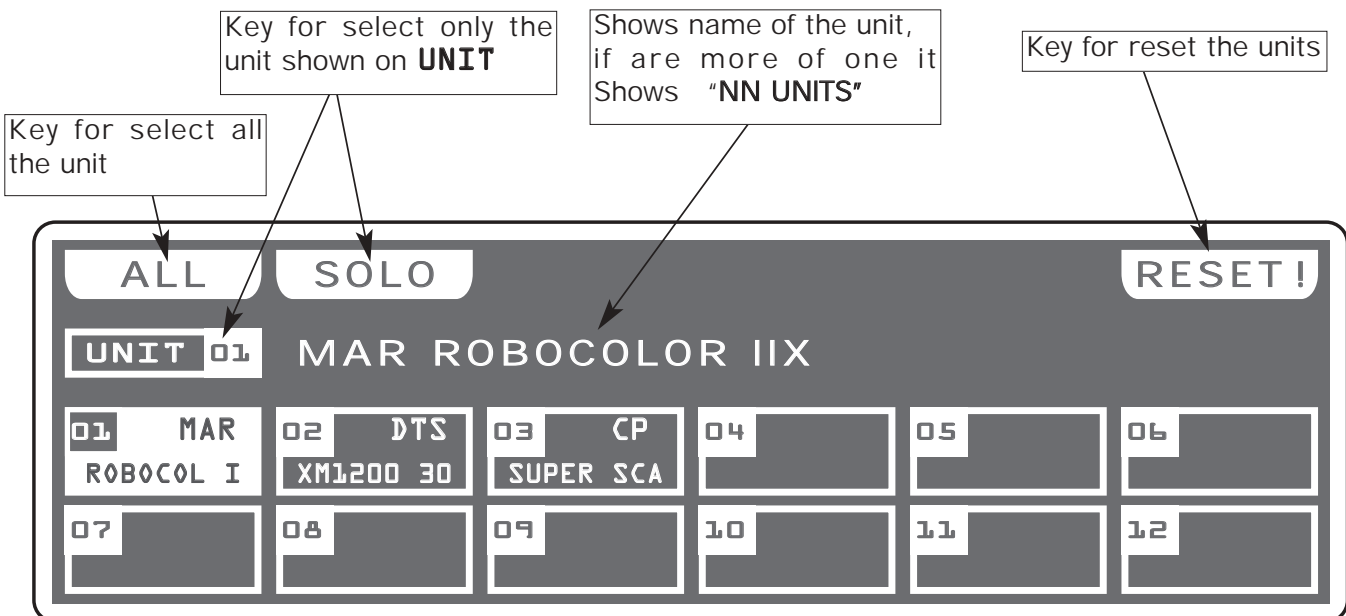

Fig. 48

ALL key:

Press this key to select all the unit from 1 to 48.

SOLO key:

Press this key to select only the unit shown in the box **UNIT**, if we have selected with the **ALL** key all the 48 unit, and we want to select only the unit (es. n° 02), press twice the key 02 of unit selection. The unit box will indicate **UNIT 02** now the **SOLO** key unselect all the other unit, activating **SOLO** the **UNIT 02**

RESET key:

Press this key to reset the selected unit

For get out of the function press the **ESC** key.

AVAILABLE ONLY AFTER THE ACTIVATION OF THE MENU FUNCTIONS (v.par.10.1)

ALLOWS TO ASSIGN THE NAME OF THE DMX CHANNEL TO DETERMINED FADERS
THIS FUNCTION IS VALID IN THE MODE OF OPERATION EDIT SCENE
(V.PAR 4.5) AND MAN (V.PAR 4.10)

This function is used when we have the need to control a determined channel (of all the connected units), always and only from a faders.

The display changes as shown in (Fig. 49).

When you keep the fader to zero value the display shows the writing ***free***, free from assignments, the channels come loaded from the controller in an original way.

Move the fader of the section "A" or "B," to assign a memorized channel.

Through the encoder or the 1/12 keys directly above at the faders you can roll forward/back for a more precise search.

To assign the channel press the **DONE** or **OK** key

For get out of the function press the **ESC** key.

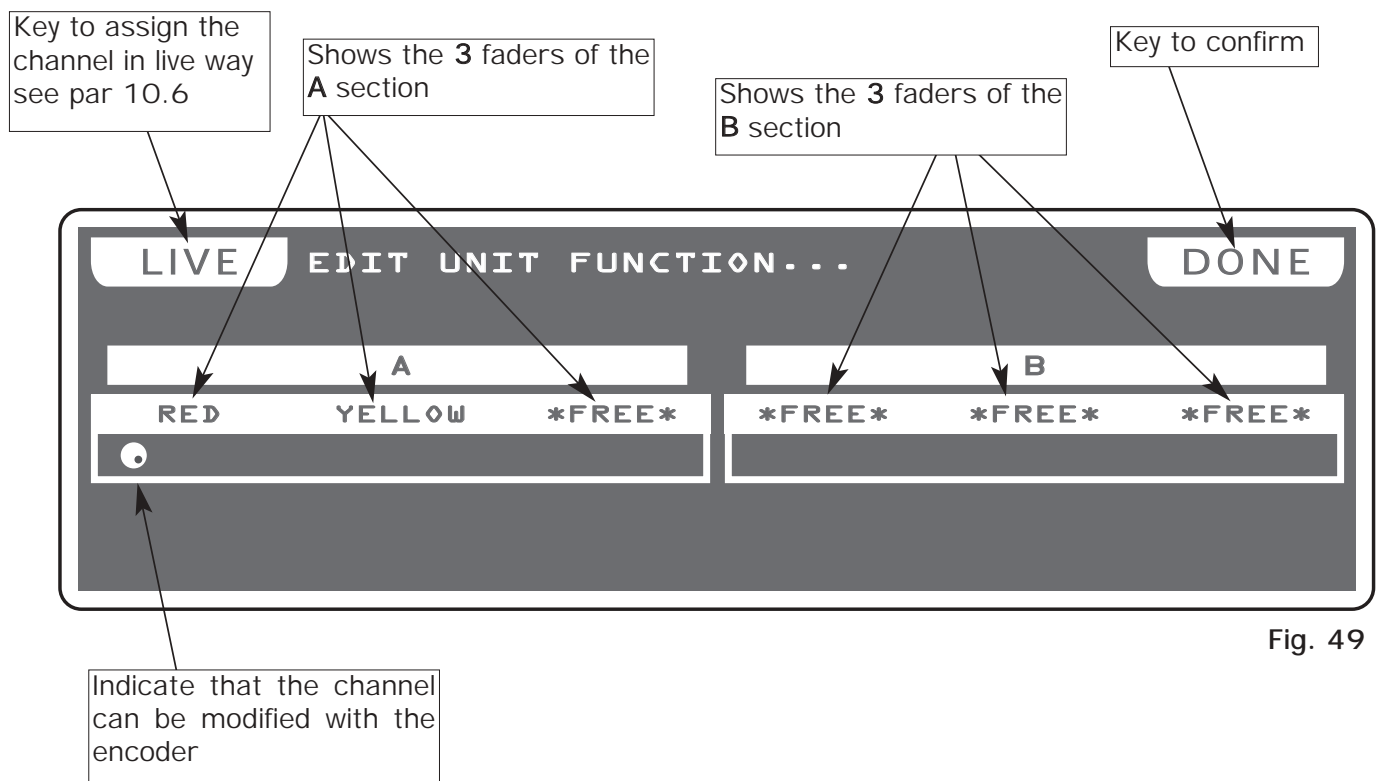

Fig. 49

AVAILABLE ONLY AFTER THE ACTIVATION OF THE MENU FUNCTIONS (v.par.10.1)

ALLOWS TO ASSIGN DIRECT CONTROL FUNCTIONS AT 12 FADERS.

This function is used to control the performance of programs, chase, effects through faders or to control a determined DMX channel.

The display changes as shown in (Fig. 50).

The functions that the operator could assign through the relative keys correspond to:

- SHW SPEED:** Performance Speed of the *Show*
- PRG SPEED:** Performance Speed of the *Program*
- CHS SPEED:** Performance Speed of the *Chase*
- EFT SPEED:** Performance Speed of the *Effect*
- EFT ZOOM:** Dimension of the *Effect*
- DMX 001:** Direct control of the channel
- FREE:** No function associate

If the function is of *DMX* type, through the faders or the encoder you select the channel.

If the function is *SPEED* or *ZOOM* (*SHW SPEED* excluded), through the faders or the encoder you select if the action of the faders is valid for all the programs/chase/effects or in the case of Show performance the 4 possible (A B, C, D)

To assign the function faders press the *DONE* or *OK* key

For get out of the function press the *ESC* key.

NOTE: THIS FUNCTION IS ACTIVE IN MODE:

SCENE/STEPS/PROG/GO! PROG/CHASE/GO! CHASE/EFFECT/GO! EFFECT/SHOW/GO! SHOW

FOR RECALL THE DISPLAY THAT SHOWS THE VALUES, PRESS THE CORRESPONDING Show, Effect, Chase, Program KEY (FIXED LED)

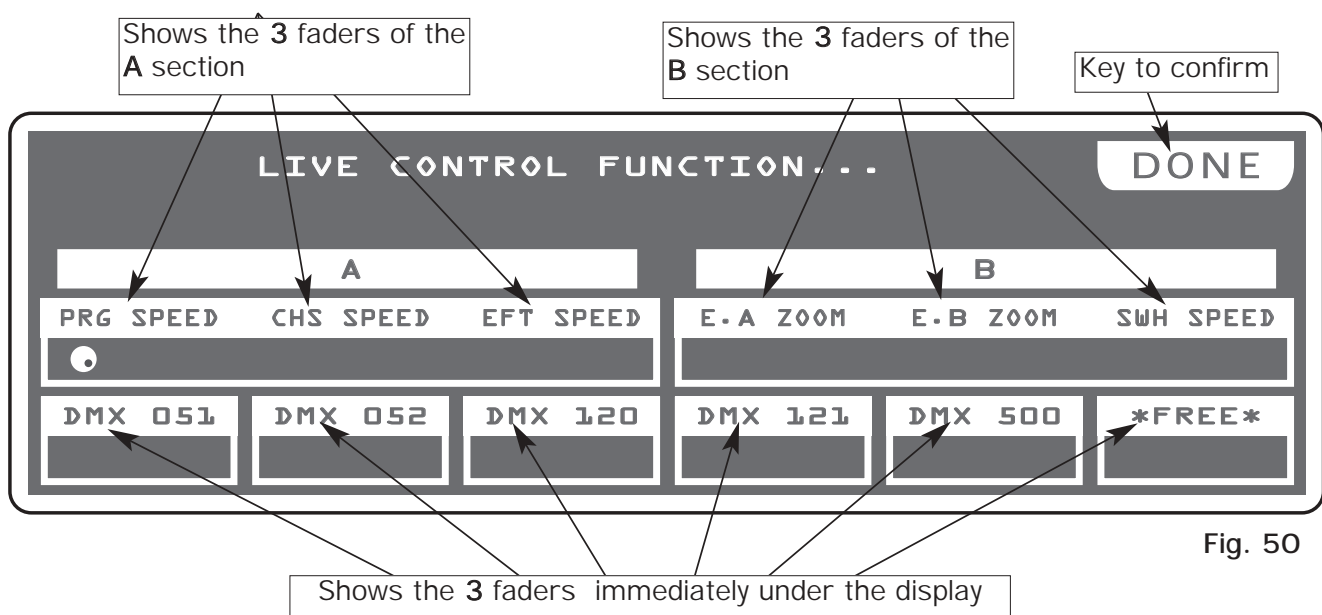

Fig. 50

AVAILABLE ONLY AFTER THE ACTIVATION OF THE MENU FUNCTIONS (v.par.10.1)

ALLOWS TO LOAD A COMPLETE SETUP FROM LIBRARY AND STORE IT IN MEMORY.
 ALLOWS TO PATCH DMX / AUTOMATIC / MANUAL.

ALLOWS TO MODIFY THE NAME OF EACH CHANNEL AND ITS PARAMETERS (RESET VALUE, BLACKOUT VALUE, HARD/SOFT CROSS) IT ALSO ALLOWS TO ASSIGN SPECIAL FUNCTIONS TO THE CHANNEL (PAN/TILT,PAN LOW/TILT LOW, LAMP CONTROL).

ATTENTION ! MODIFICATION OF THE EDIT DMX PATCH PARAMETERS, IF NOT EFFECTED IN AN APPROPRIATE WAY, PREVENTS THE CONNECTED UNIT TO WORK CORRECTLY.

The display changes as shown in (Fig. 51).

Press one of the 1÷12 keys to select the unit.

For successive unit use the **PAGE** key

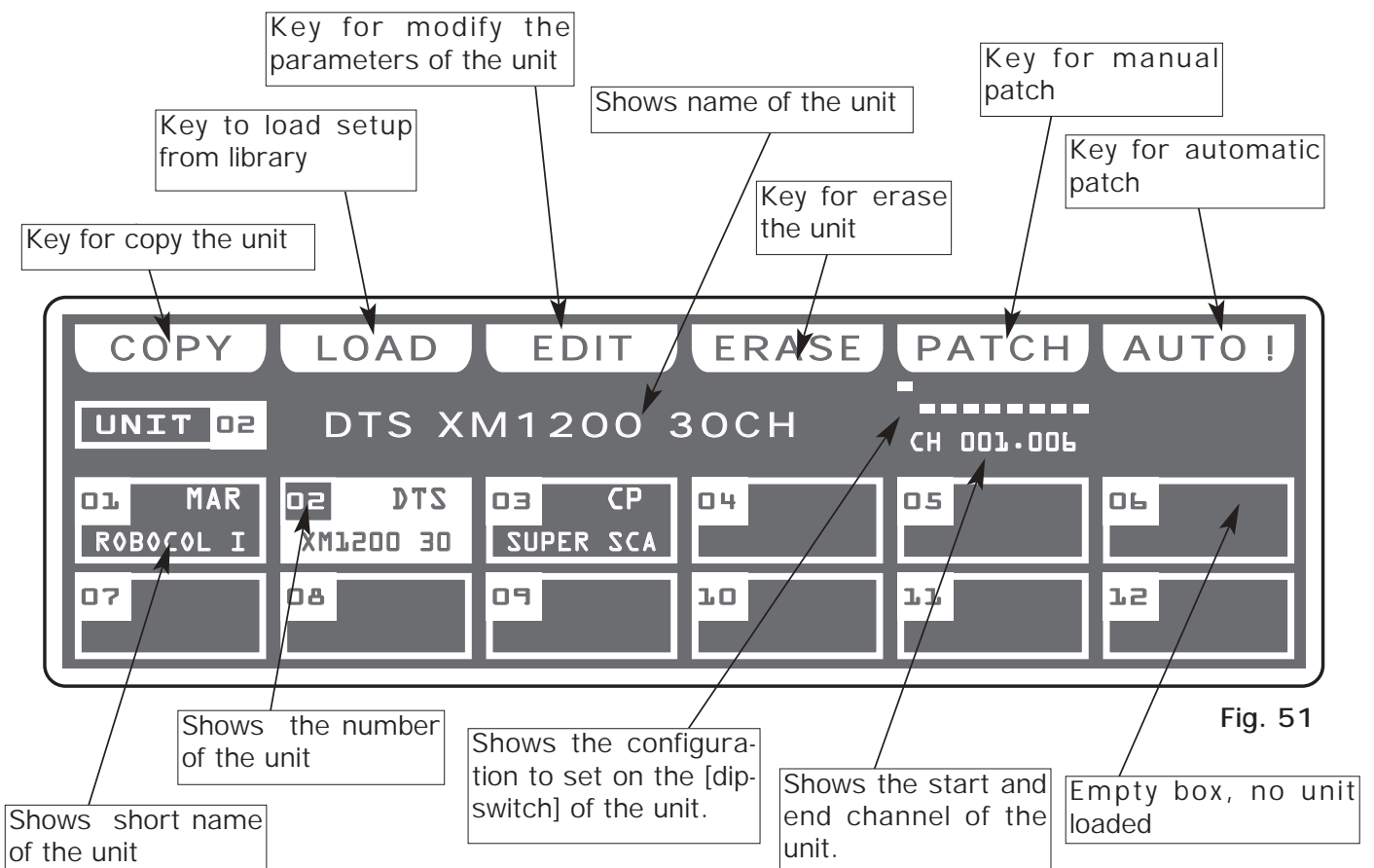

Fig. 51

In EDIT DMX PATCH mode there are 6 function keys see (Fig. 51 par 10.7).

COPY Key:

Pressing this key on the display shows " SELECT DESTINATION UNIT", select through the 1÷12 keys the destination of the copy.

For the successive unit use **PAGE** key

LOAD Key:

Press this key to load complete setup from library, see par 10.9.

EDIT Key:

Press this key to modify the name of each channel and its parameters, see par 10.11.

ERASE Key:

Press this key to the erase active unit, select through the 1÷12 keys (for the successive units use **PAGE** key) the unit that must be erased, then press the **ERASE** key.

The unit will be erased in a permanent way, it is not possible to recover it.

PATCH Key:

Press this key to modify start address of the unit, use the fader under *PATCH* write or the encoder. For confirm the modify press the **OK** key, for get out of the function press the **ESC** key.

Top 48 will calculate the last channel for that unit and under *PATCH* write you can show the configuration to set on the dip-switch of the unit.

NOTE: ANY BUILDERS ADOPT THE CONFIGURATION OF THE DIP-SWITCH LIKE STANDARD SET TO "0" FOR INDICATE DMX CHANNEL "1." IN THIS CASE FOR A CORRECT OPERATION, YOU MUST BE ADDED +1" (EXAMPLE ADDRESS OF UNIT START = 128 ---> TOP 48 ADDRESS = 129

The on position of the dip-switch is with white box appears aloft.

When you exit from the menu the software controls if there are units with equal or overlapped addresses, the display shows a message of error "PATCH OVERLAY AT UNIT."

AUTO Key:

Press this key to modify start address in automatic way, select through the 1÷12 keys the unit of start, then press the **AUTO** key.

For the successive unit use **PAGE** key

Now from the unit of start to the last unit the addresses have been assigned.

For the successive unit use **PAGE** key

AVAILABLE ONLY AFTER THE ACTIVATION OF THE MENU FUNCTIONS (v.par.10.7)
 ALLOWS TO LOAD A COMPLETE SETUP FROM LIBRARY AND STORE IT IN MEMORY.

Press the **LOAD** key to load setup from library (Fig. 52).

The display changes as shown in (Fig. 53).
 The display shows the first unit in the library

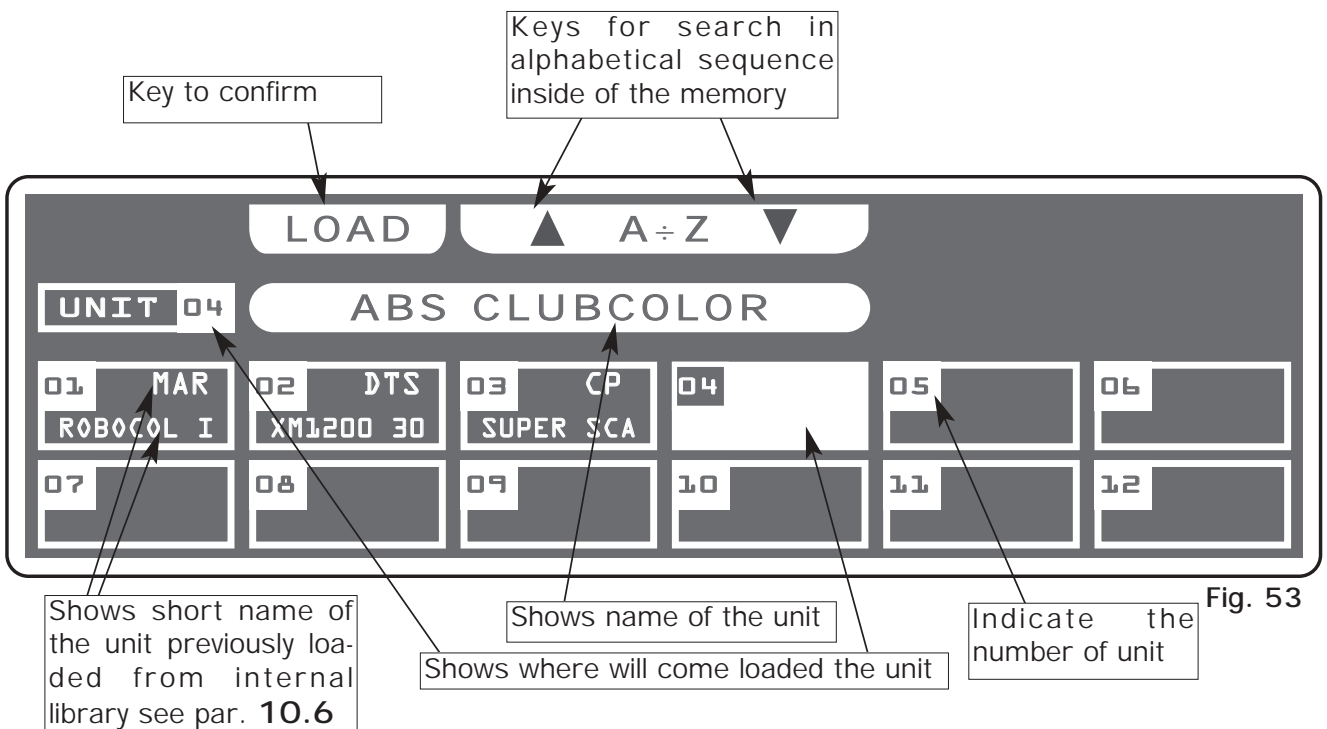
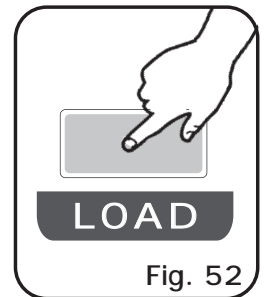

Fig. 53

10.10 FUNCTION KEYS IN LOAD LIBRARY MODE

In **LOAD LIBRARY** mode there are 3 function keys see (Fig. 53)

A ÷ Z Key:

Press this key to search in alphabetical sequence inside of the memory, when you arrive at the initial letter of the firm, you can search through the encoder in fine way. For a rapid search could be used also the faders under **LOAD** write

LOAD Key:

Press this key to load the select unit in the box highlighted.
 For get out of the function press the **ESC** key.

AVAILABLE ONLY AFTER THE ACTIVATION OF THE MENU FUNCTIONS (v.par.10.7)

ALLOWS TO MODIFY THE NAME OF EACH CHANNEL AND ITS PARAMETERS (RESET VALUE, BLACKOUT VALUE, HARD/SOFT CROSS) IT ALSO ALLOWS TO ASSIGN SPECIAL FUNCTIONS TO THE CHANNEL (PAN/TILT,PAN LOW/TILT LOW, LAMP CONTROL).

The graphic display indicates the unit (**highlighted**) currently active (Fig. 51 par 10.7) for modify it press the **EDIT** key (Fig. 54).

The display changes as shown in (Fig. 56).

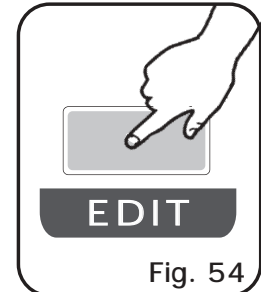

Fig. 54

Pressing the **NAME** key it is possible modify the name of the projector, the display changes as shown in (Fig. 55).

Through the encoder we select the character, with the **OK** key or the **CHAR** keys we modify the next/precedent character. Press **DONE** key to confirm the modify of the name.

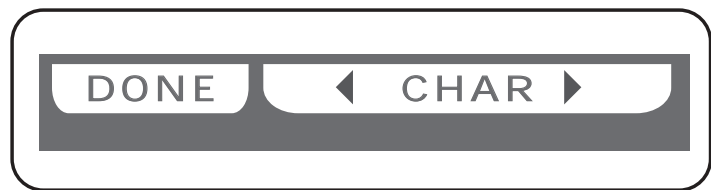

Fig. 55

Key for return to the menu function see par 10.7

Key for modify the name of the unit

BACK
NAME

UNIT 02
DTS XM1200 30CH

CH01 PAN	CH02 PAN LOW	CH03 TILT	CH04 TILT LOW	CH05 COLOUR	CH06 CYAN
CH07 MAGENTA	CH08 YELLOW	CH09 B DIMMER	CH10 B SHUT/STR	CH11 B ZOOM	CH12 M-SPEED

Shows name of the channel

Shows that the channel is hard cross

Shows that the channel is soft cross

Shows that the channel have a blackout value with **B.** a reset value with **R.** a blackout and reset value with **BR.**

Indicate the number of the channel

Fig. 56

AVAILABLE ONLY AFTER THE ACTIVATION OF THE **MENU** FUNCTIONS (v.par.10.11)

Through the 1÷12 keys select the number of the channel to modify see (Fig. 56 par 10.11).

For the successive channels use **PAGE** key

The selected channel will come highlighted the display changes as shown in (Fig. 57).

For use **Function Keys** see par 10.13

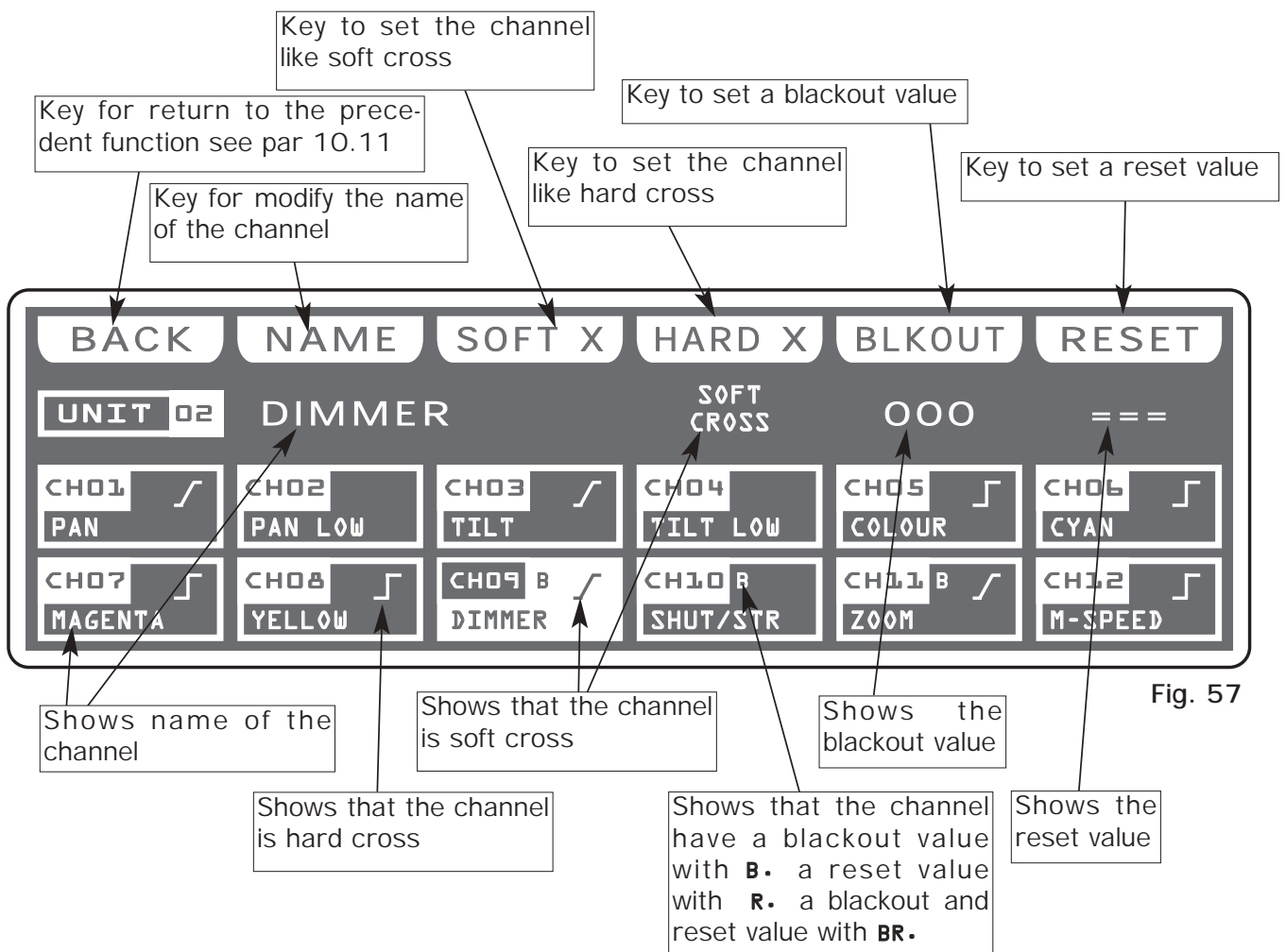

The controller uses these special channels for predefined functions, you must use them for the specific functions assigned to them.

NOT USED -> Not used channel.

PAN -> Pan channel (SOFT CROSS/HARD CROSS).

PAN LOW -> Pan channel LOW.

TILT -> Tilt channel (SOFT CROSS/HARD CROSS).

TILT LOW -> Tilt channel LOW.

LAMP -> Lamp control channel.

LAMP/RES -> Like LAMP.

In EDIT DMX CHANNEL mode there are 6 function keys see (Fig. 57 par 10.12).

BACK Key:

Press this key for return to the precedent function see par 10.11

NAME Key:

Press this key to replace the channel name.

Use the fader under NAME write or the encoder. For confirm the modify press the **NAME** or **OK** key.

Putting the faders to 0 value *CUSTOM* appears on the display, now we can write the name of the channel.

Pressing again **NAME** key the display changes as shown in (Fig. 58).

Through the encoder choose the character, Through the **OK** or

CHAR Key we insert/modify the next/precedent character.

Press **DONE** key to confirm the modify of the name.



Fig. 58

The value change between two scenes can be immediate (**HARD CROSS**) or gradual (**SOFT CROSS**).

SOFT X Key:

Press this key to set for the selected channel the type of gradual change (**SOFT CROSS**).

HARD X Key:

Press this key to set for the selected channel the type of immediate change (**HARD CROSS**)

BLKOUT Key:

Press this key to modify "**BLACKOUT VALUE**" that is the value of the channel when the **BLACKOUT** function is active (v.par.10.2).

Through the encoder or the fader under the **BLKOUT** write, you can select === (unchanged) value or 0 / 255 value. The === value is selected putting the fader to 0 and it allows to maintain unchanged the output value (no blackout for this channel).

RESET Key:

Press this key to modify "**RESET VALUE**" that is the value of the channel when the **MENU: RESET** function is active (v.par.10.4).

Through the encoder or the fader under the **RESET** write, you can select === (unchanged) value or 0 / 255 value. The === value is selected putting the slider to 0 and it allows to maintain unchanged the output value (no reset for this channel).

Only if the **LAMP** or **LAMP/RES** channel is selected you can modify the **LAMP ON /LAMP OFF** value. see (Fig. 59).

L-ON Key:

Press this key to modify "**LAMP ON VALUE**" that is the value of the channel when the **MENU: LAMP ON** function is active (v.par.10.3).

Through the encoder or the fader under the **L-ON** write, you can select 0 / 255 value.

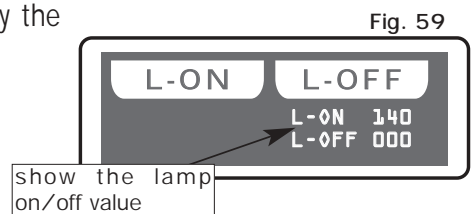

Fig. 59

L-OFF Key:

Press this key to modify "**LAMP OFF VALUE**" that is the value of the channel when the **MENU: LAMP OFF** function is active (v.par.10.3).

Through the encoder or the fader under the **L-OFF** write, you can select 0 / 255 value.

10.14 MENU: SYSTEM SETTINGS

GB

AVAILABLE ONLY AFTER THE ACTIVATION OF THE MENU FUNCTIONS (v.par.10.1)

ALLOWS TO CHANGE THE DISPLAY CONTRAST, TO SET A PASSWORD, RS 232 FUNCTIONS, SHOW THE SOFTWARE VERSION.

Select **SYSTEM SETTINGS** from main menù the display changes as shown in (Fig. 60)

As soon as this function is activated, the display shows the first function available.

Through the encoder it is possible select the **SYSTEM SETTINGS** functions available. To activate the selected function press the same (OK) key.

Fig. 60

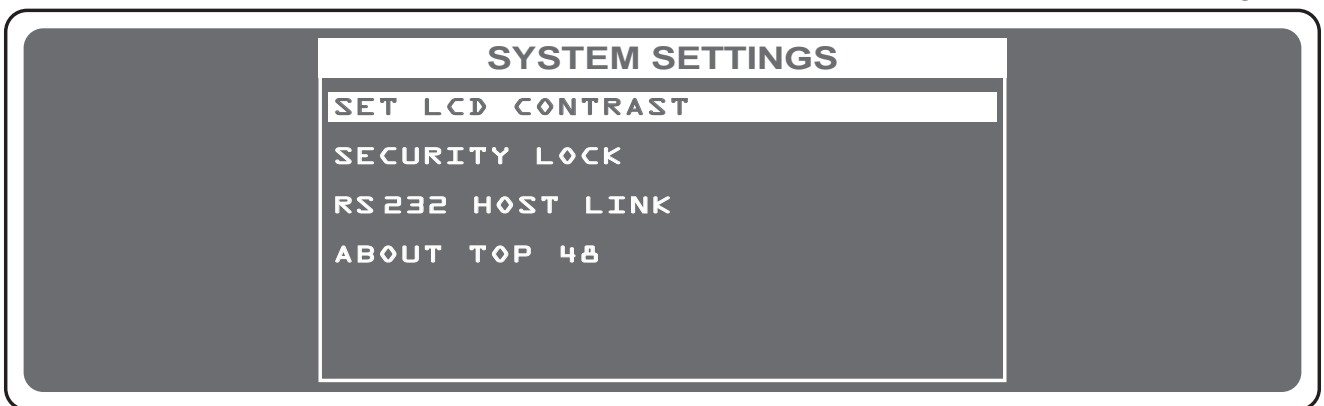

10.15 MENU: SET LCD CONTRAST

DISPONIBILE SOLO DOPO L'ATTIVAZIONE DELLA FUNZIONE SYSTEM SETTINGS (v.par.10.14)

THIS FUNCTION ALLOWS TO CHANGE THE GRAPHIC DISPLAY CONTRAST

The display changes as shown in (Fig. 61)

Fig. 61

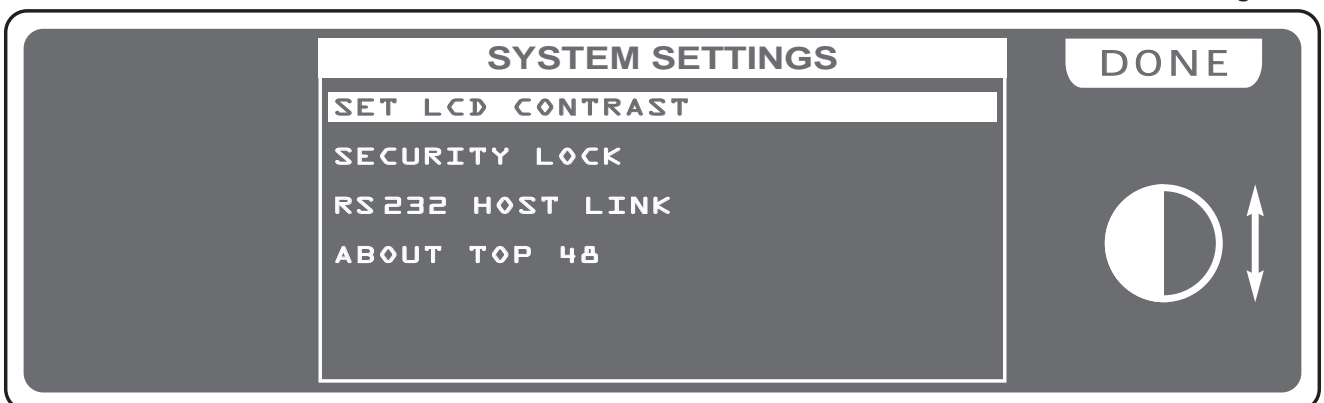

Through the encoder or the fader under the **DONE** write, you can modify the display contrast. For confirm the modify press the **OK** key, for get out of the function press the **ESC** key.

AVAILABLE ONLY AFTER THE ACTIVATION OF THE SYSTEM SETTINGS (v.par.10.14)

ALLOWS TO LOCK/UNLOCK FUNCTIONS OF EDITING.

Pressing the **LOCK** key the display will change as shown in (Fig. 62)

Through the 1÷10 keys, insert a numerical combination of 5 number for lock the functions.

At the end of the last number Top 48 will ask **"ENTER PASSWORD AGAIN"**, you must introduce the password again. Now Top 48 is locked.

For unlock it repeat again all the above steps list above, but you must remember the password.

If you forget the password, we have a code of unblocking that is:

1 3 9 7 + FUNCTION KEYS N°02

Fig. 62

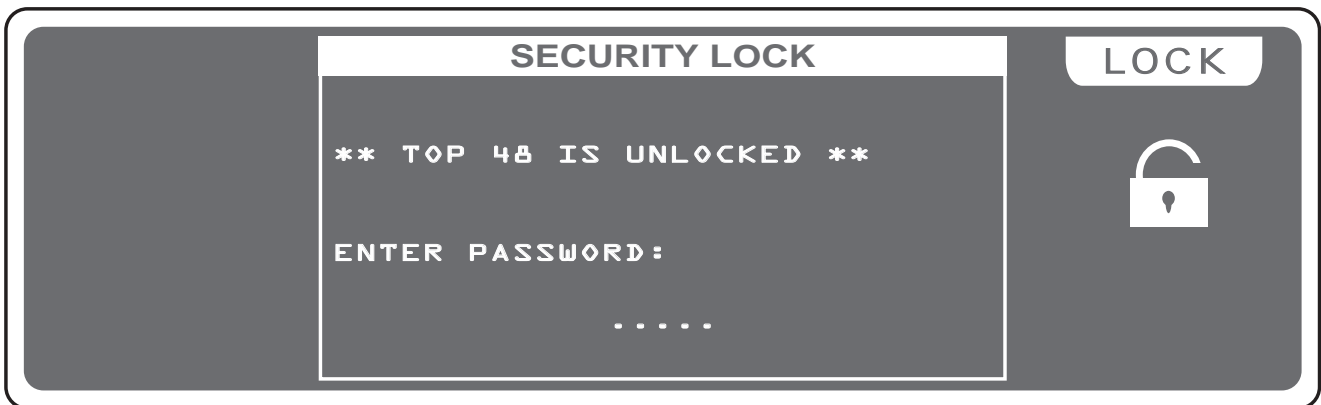

AVAILABLE ONLY AFTER THE ACTIVATION OF THE SYSTEM SETTINGS (v.par.10.14)

ALLOWS TO SHOW THE SOFTWARE VERSION.

The display changes as shown in (Fig. 63)

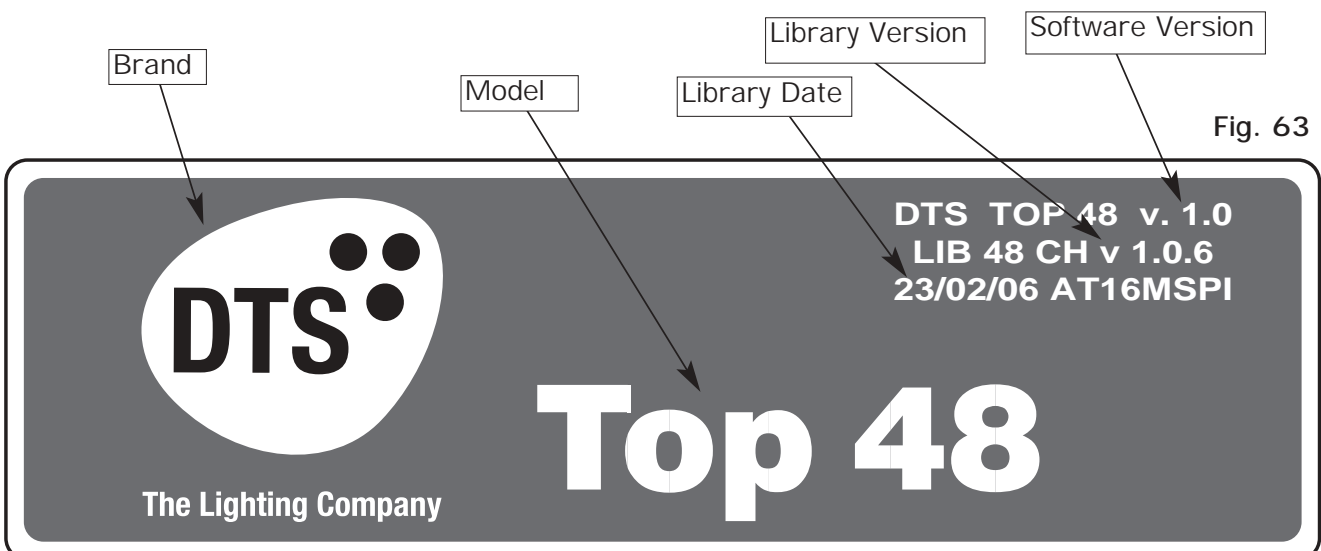
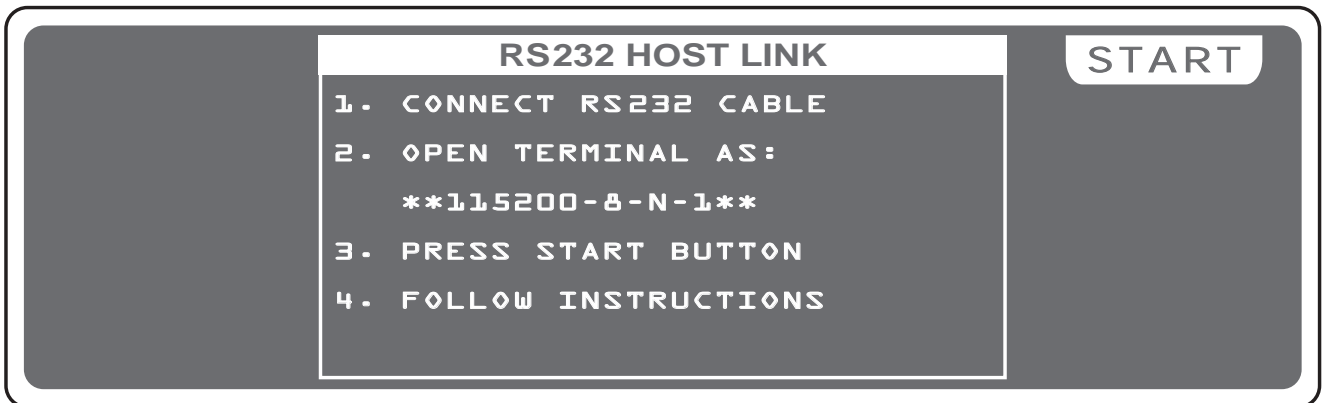

Fig. 63

AVAILABLE ONLY AFTER THE ACTIVATION OF THE SYSTEM SETTINGS (v.par.10.14)

THIS FUNCTION ALLOWS TO UPDATE LIBRARY, SAVE THE PROGRAMMING AND TO RESTORE USER DATA.

The display changes as shown in (Fig. 64)



Connect the RS 232 cable (included) from the Top 48 to the RS 232 of the Computer, start a program of terminal emulation and to set the communication like:

115200 bps, 8 data bit, no parity, 1 stop bit.

With **Microsoft Windows**[®] system start the software **Hyper Terminal** (Start> Programs> Accessories> Communications), set the connection like in **fig.65-66-67**.

Press the **START** key (Top 48); in the monitor of Computer appears the Menù see **fig.68**.

Press (**Computer Keyboard**) the number of the desired function.

Press **1** to save the data of programming;

You must select from the menù **Transfer> Receive file**. Set **Ymodem** protocol then click to **Receive** The saved file is in the Hard Disk with name **TOP 48.BAK**.



Fig. 65



Fig. 66

Press **2** to restore the data of programming;
 You must select from the menu **Transfer> Send file**. search the file with **TOP 48.BAK** name, set **Ymodem** protocol then click to **Send**.

Press **3** to update setup library;
 you must select from the file menu **Transfer> Send file**. search the file with **TOP48_lib.bin** name (downloaded from internet), set **Ymodem** protocol then click to **Send** see fig.69.

Press **4** to go out of **RS 232 HOST LINK** function, close the application and disconnect the cable.



Fig. 67

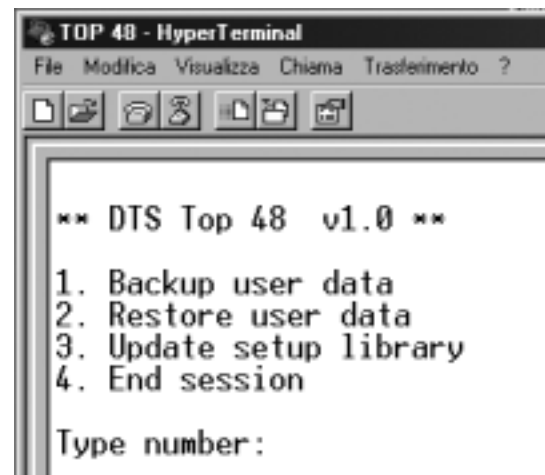

Fig. 68

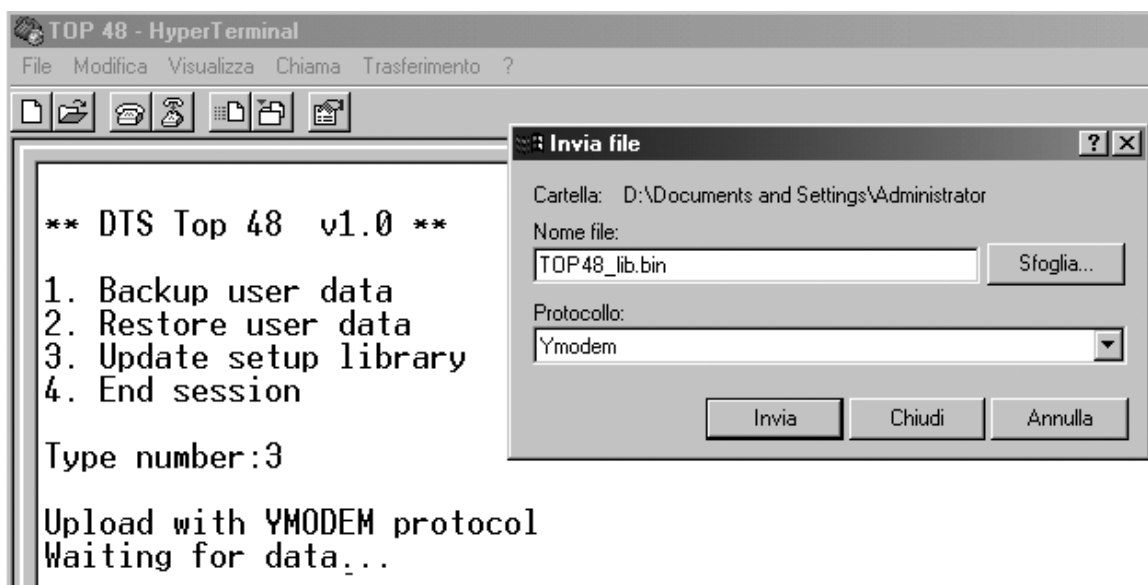

Fig. 69

TECHNICAL FEATURES OF TOP 48

- Individual control of up to **36 DMX 512 units**.
- **48 DMX channels** for each unit.
- **512 DMX** configurable channels for intelligent units and dimmers, **144** channels (maximum) for dimmers.
- **48 Program processor** with **48 scenes** each one (2304 total scenes).
- **48 Chase processor** with **48 scenes** each one (2304 total scenes).
- **48** Built in **Effect** modifiable.
- **96 Show** with **4 Program, 4 Chase, 4 Effect**
- **RS-232** for connection with a PC.
- **DMX 512/1990 standard output** (5-pin female "XLR" connector).
- **240X64 pixel GRAPHIC** white led backlight **LCD DISPLAY** for a simple control of each channel, function and setting.
- Very easy **SETUP** with **wide LIBRARY**, allows the configuration of each unit connected to the **Top 48**.
- Control of the **48** channels by **12** faders for simplest use.
- **Compatible with every DMX 512 unit (max 48 channels)**
 - **Programmable channels name and function.**
- **8 / 16 bit PAN and TILT movements** controlled by an auto-return Joystick with 9 fixed speeds + "fine" or proportional mirror movement, for quick and fine positioning.
- **SHOW** function executes **4 Program, 4 Chase, 4 Effect simultaneously**.
- **PROGRAM** function executes one or more programs.
- **EFFECT** function plays pre-programmed movements, dedicated to moving heads and scanners.
- **SCENE** function executes one of the **48** scenes of a program.
- **MAN** function for manual control of one or more units, while the others run a program or a chase.
- **PAGE** key for fast page select.
- **12** keys for the selection of show, programs, chase, scenes, units, and effect.
- Independent regulation of **SPEED** and **CROSS** value for programs, chase and scenes.
- **LENGTH, COPY, REPEAT, PATCH** functions.
- **RESET SCANNER, LAMP ON, LAMP OFF, BLACKOUT** functions.
- **MUSIC** function with independent speed.
- **Built-in microphone** and **0 dB audio input** with auto-level control.
- Non volatile **16 Mbit FLASH** memory with **40** years data retention.
- **Very simple programming and intuitive use.**

Climatic condition for the use

Humidity: **35% ÷ 80%**

Temperature: **5 ÷ 50 °C**

Dimensions and weight

Dimension (W x L x H) / Weight: **482 x 95 x 176 mm (2U rack) / 3,5 Kg.**

Note

D.T.S. Illuminazione srl -Via Fagnano Selve 10-12-14, (Loc. La Cella)
47843 Misano Adriatico (RN) ITALY - Tel. +39 0541 611131 Fax +39 0541 618210
www.dts-lighting.it - e-mail: info@dts-lighting.it



All rights reserved. No parts of this document can be copied, photocopied or reproduced without the prior written permission of the **D.T.S. Illuminazione S.r.l.**

No responsibility is taken for possible inaccuracies or mistakes.

The **D.T.S. Illuminazione S.r.l.** reserves the right to make any alterations or aesthetics changes of this product that seem necessary at any time and for whatever reason.

The **D.T.S. Illuminazione S.r.l.** takes no responsibility for the use or for the application of this product.
