

Panasonic

Operating Instructions

Network Video Encoder

Model No. **WJ-GXE500**

WJ-GXE500E

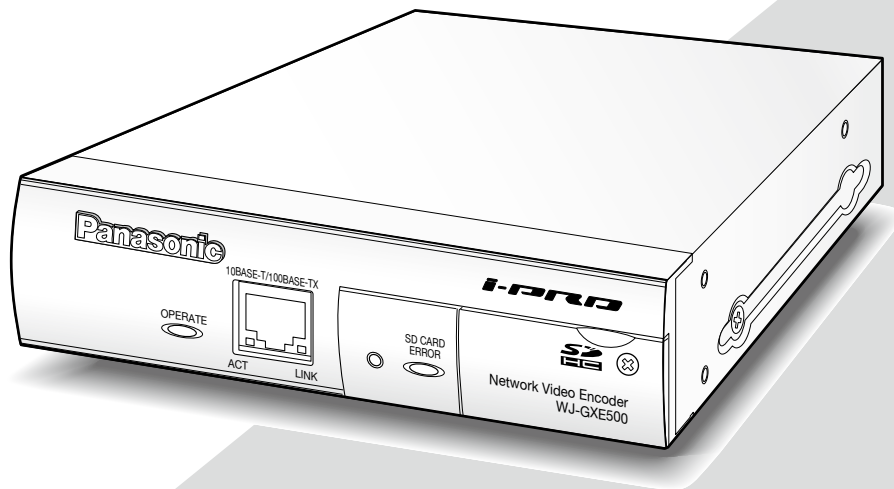

Before attempting to connect or operate this product,
please read these instructions carefully and save this manual for future use.

The model number is abbreviated in some descriptions in this manual.

CONTENTS

Preface	3	[Multi-screen] page.....	44
About the user manuals	3	[Multi-screen setup] tab	44
Trademarks and registered trademarks	3	[Alarm] page	45
Abbreviations	3	[Alarm] tab	45
Viewer software	4	[VMD area] tab.....	46
About the network security	4	[Notification] tab	48
Equipped security functions.....	4	[Advanced func.] page	49
Monitor images on a PC.....	5	[XML notification] tab	49
Monitor images from a single camera.....	5	[Face detection] tab	49
About the "Live" page	7	[User mng.] page.....	50
Monitor images from multiple cameras.....	11	[User auth.] tab.....	50
Record images on the SD memory card manually....	12	[Host auth.] tab.....	50
Action at an alarm occurrence	13	[System] tab	51
Alarm type	13	[Server] page	52
Action at an alarm occurrence	13	[Mail] tab.....	52
Transmit images onto an FTP server.....	15	[FTP] tab	52
Transmit an alarm image at an alarm occurrence		[NTP] tab	53
(Alarm image transmission).....	15	[Network] page	54
Transmit images at a designated interval or		[Network] tab	54
period (FTP periodic image transmission).....	15	[DDNS] tab	55
Save images on the SD memory card when		[SNMP] tab	56
images have failed to be transmitted using the		[FTP img. trans.] tab	56
FTP periodic image transmission function.....	16	[Schedule] page.....	57
Display the log list	17	[Schedule] tab	57
About the log list window	17	About the displayed system log.....	58
Playback of images on the SD memory card.....	19	Troubleshooting.....	60
About the playback page	19	Appendix	68
Maintenance of the unit [Maintenance]	21	Possible number of images that can be saved	
Check the system log [System log].....	21	on the SD memory card (as indications)	68
Upgrade the firmware [Upgrade].....	22	How the logs and images are saved depending	
Reset the settings/Reboot the unit		on the settings for "Alarm"	69
[Default reset]	23	How the logs and images are saved depending	
Viewing Help.....	24	on the settings for "Manual"	70
Displaying the Help screen.....	24	How the logs and images are saved depending	
Display the setup menu from a PC	25	on the settings for "FTP error"	71
How to display the setup menu	25	Directory structure of drive B	72
How to operate the setup menu	26		
About the setup menu window	27		
Setup menu and its items	28		
[Basic] page.....	30		
[Basic] tab	30		
[SD memory card] tab	31		
[Log] tab	33		
[Image/Audio] page	34		
[JPEG/H.264] tab	34		
[JPEG/MPEG-4] tab	37		
[Image/Position] tab	40		
[Audio] tab	41		
[Coaxial/RS-485] tab	42		

Preface

About the user manuals

There are 2 sets of operating instructions for the WJ-GXE500 (NTSC model), WJ-GXE500E (PAL model) as follows.

- Installation Guide: Explains how to install and connect devices.
- Operating Instructions (PDF): Explains how to perform the settings and how to operate this unit.

Adobe® Reader® is required to read these operating instructions (PDF) on the provided CD-ROM.

When the Adobe® Reader® is not installed on the PC, download the latest Adobe® Reader® from the Adobe web site and install it.

"WJ-GXE500" shown in the instructions and illustrations used in these operating instructions indicates the WJ-GXE500, WJ-GXE500E.

The screens used in these operating instructions show the case of NTSC model.

Refer to the readme file on the provided CD-ROM for further information including the dedicated software, its version, and compatible cameras.

Trademarks and registered trademarks

- Microsoft, Windows, Windows Vista, Internet Explorer, ActiveX and DirectX are either registered trademarks or trademarks of Microsoft Corporation in the United States and/or other countries.
- Adobe, the Adobe logo, and Reader are either registered trademarks or trademarks of Adobe Systems Incorporated in the United States and/or other countries.
- SDHC logo is a trademark.
- Other names of companies and products contained in these operating instructions may be trademarks or registered trademarks of their respective owners.

Abbreviations

The following abbreviations are used in these operating instructions.

Microsoft® Windows® 7 Professional (64-bit) and Microsoft® Windows® 7 Professional (32-bit) are described as Windows 7.

Microsoft® Windows Vista® Business SP1 (32-bit) is described as Windows Vista.

Microsoft® Windows® XP Professional SP3 is described as Windows XP.

Windows® Internet Explorer® 8.0, Windows® Internet Explorer® 7.0 and Microsoft® Internet Explorer® 6.0 are described as Internet Explorer.

SDHC/SD memory card is described as SD card or SD memory card.

Viewer software

It is necessary to install the viewer software "Network Camera View 4" to display images on a PC. This software can be installed directly from the network video encoder WJ-GXE500 or WJ-GXE500E (hereinafter, the unit) or by double clicking "nwcv4setup.exe" on the CD-ROM provided, and then following the on-screen instructions.

Important:

- The default setting of "Automatic installation of Viewer software" is "On". Follow the instructions on page 66 when the message is displayed on the information bar of the browser.
- When the "Live" page is displayed for the first time, the install wizard of the ActiveX control required to display images from the camera will be displayed. Follow the instructions of the wizard.
- When the install wizard is displayed again even after completing the installation of the ActiveX, restart the PC.
- The viewer software used on each PC should be licensed individually. The number of installations of the viewer software from the unit can be checked on the [Upgrade] tab of the "Maintenance" page (☞ page 22). Refer to your dealer for the software licensing.

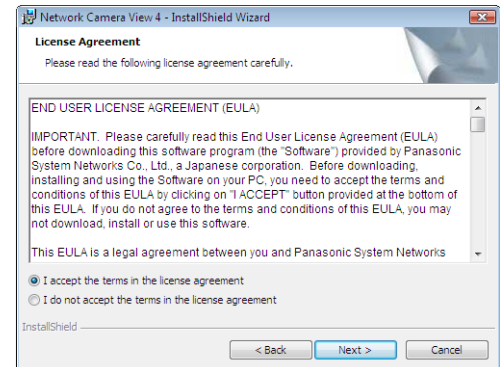

About the network security

Equipped security functions

The following security functions are featured in this unit.

- ① Access restrictions by the host authentication and the user authentication
It is possible to restrict users from accessing the unit by setting the host authentication and/or the user authentication to "On". (☞ Page 50)
- ② Access restrictions by changing the HTTP port
It is possible to prevent illegal access such as port scanning, etc. by changing the HTTP port number. (☞ Page 54)

Important:

- Leakage of information such as image data, authentication information (user name and password), alarm mail information, FTP server information, DDNS server information, etc. can happen. Perform the countermeasure such as the access restriction using the user authentication.
- After the unit is accessed by the administrator, make sure to close the browser for added security.
- Change the administrator password periodically for added security.

Note:

- When user authentication (authentication error) has failed to pass 8 times within 30 seconds using the same IP address (PC), access to the unit will be denied for a while.
-

Monitor images on a PC

The following are descriptions of how to monitor images from the camera on a PC.

Monitor images from a single camera

Step 1

Start up the web browser.

Step 2

Enter the IP address designated using the Panasonic Easy IP Setup software in the address box of the browser.

Example when entering an IPv4 address:

http://URL registered using IPv4 address

http://192.168.0.10/

Example when entering an IPv6 address:

http://URL registered using IPv6 address

http://[2001:db8::10]/

<Example of IPv4 access>

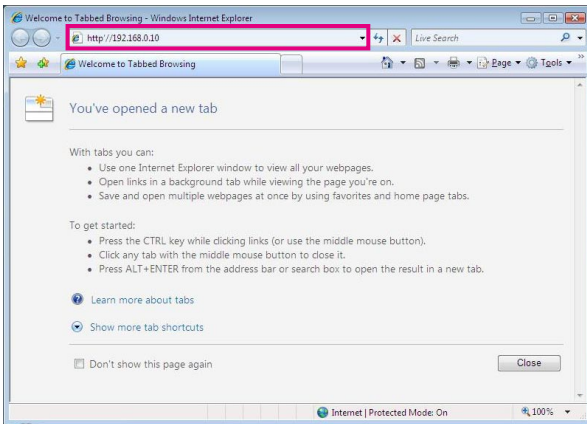

<Example of IPv6 access>

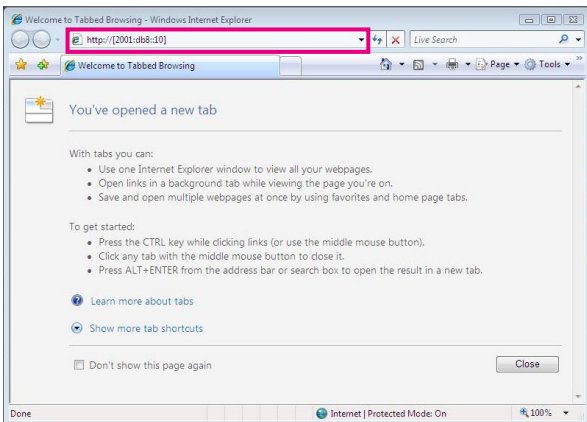

Important:

- When the HTTP port number is changed from "80", enter "http://IP address of the unit + : (colon) + port number" in the address box of the browser.
Example: When the port number is set to "8 080"
http://192.168.0.11:8080
- When the unit is in a local network, configure the proxy server setting of the web browser (under "Internet Options..." under "Tools" of the menu bar) to bypass the proxy server for the local address.

Step 3

Press the [Enter] key on the keyboard.

→ The "Live" page will be displayed. Refer to page 7 for further information about the "Live" page.



When "On" is selected for "User authentication", the authentication window will be displayed before displaying live images for the user name and password entries.

The default user name and password are as follows.

User name: admin

Password: 12345

Important:

- To enhance the security, change the password for the user "admin". It is recommended to change this password periodically.
 - When displaying multiple H.264 (or MPEG-4) images on a PC, images may not be displayed depending on the performance of the PC.
-

Note:

- When "H.264" is selected for "Video encoding format", H.264 video will be displayed. When "MPEG-4" is selected, MPEG-4 images will be displayed.
- When multiple users are receiving audio, the frame rate of H.264 (or MPEG-4) images or the refresh interval of JPEG images may be lower than the specified value.
- The maximum number of concurrent access user is 14 including users who are receiving H.264 (or MPEG-4) images and users who is receiving JPEG images. Depending on the set values for "Bandwidth control (bit rate)" and "Max bit rate (per client) **", the maximum concurrent access number may be less than 14 users. When 14 users are concurrently accessing, the access limit message will be displayed for users who subsequently attempt to access. When "Multicast" is selected for "Transmission type" of "H.264" (or "MPEG-4"), only the first user who accessed to monitor H.264 (or MPEG-4) images will be included in the maximum number. The second and subsequent users who are monitoring H.264 (or MPEG-4) images will not be included in the maximum number.
- When "On" is selected for "H.264 transmission" (or "MPEG-4 transmission") (see pages 34 to 40), H.264 (or MPEG-4) images will be displayed. When "Off" is selected, a JPEG image will be displayed. It is possible to display a JPEG image even when "On" is selected for "H.264" (or "MPEG-4 transmission").
- The refresh interval may become longer depending on a network environment, PC performance, photographic subject, access traffic, etc.

<Refresh interval of JPEG images>**When "Ch1 only" is selected for "Ch selection"**

When "On" is selected for "H.264 transmission" (or "MPEG-4 transmission")

- JPEG (VGA, QVGA, D1): 15 fps (NTSC model), 12.5 fps (PAL model)

When "Off" is selected for "H.264 transmission" (or "MPEG-4 transmission")

- JPEG (VGA, QVGA, D1): 30 fps (NTSC model), 25 fps (PAL model)

When "Ch1-2" is selected for "Ch selection"

When "On" is selected for "H.264 transmission" (or "MPEG-4 transmission")

- JPEG (VGA, QVGA, D1): 15 fps (NTSC model), 12.5 fps (PAL model)

When "Off" is selected for "H.264 transmission" (or "MPEG-4 transmission")

- JPEG (VGA, QVGA, D1): 15 fps (NTSC model), 12.5 fps (PAL model)

When "Ch1-3" is selected for "Ch selection"

When "On" is selected for "H.264 transmission" (or "MPEG-4 transmission")

- JPEG (VGA, QVGA, D1): 10 fps (NTSC model), 8.3 fps (PAL model)

When "Off" is selected for "H.264 transmission" (or "MPEG-4 transmission")

- JPEG (VGA, QVGA, D1): 15 fps (NTSC model), 12.5 fps (PAL model)

When "Ch1-4" is selected for "Ch selection"

When "On" is selected for "H.264 transmission" (or "MPEG-4 transmission")

- JPEG (VGA, QVGA): 3 fps (NTSC model), 3.1 fps (PAL model)
- JPEG (D1): 2 fps (NTSC model), 2.1 fps (PAL model)

When "Off" is selected for "H.264 transmission" (or "MPEG-4 transmission")

- JPEG (VGA, QVGA, D1): 15 fps (NTSC model), 12.5 fps (PAL model)
-

About the "Live" page

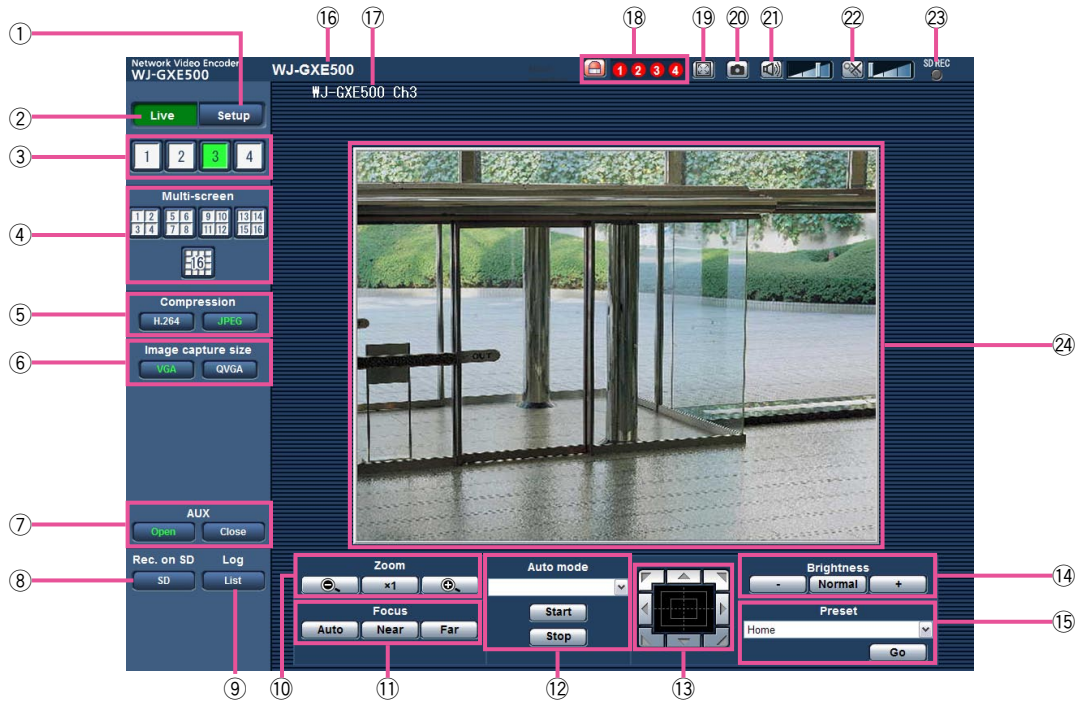

① **[Setup] button (*1)**

The button will turn green and the setup menu will be displayed.

② **[Live] button**

Display the "Live" page. The button will turn green and the "Live" page will be displayed.

③ **[1] to [4] buttons**

The button will turn green and the "Live" page of the corresponding channel will be displayed. It is possible to select a desired channel by clicking the [1] to [4] buttons.

④ **[Multi-screen] buttons**

Images from multiple cameras can be displayed on a multi-screen by registering cameras on the setup menu. (☞ Page 11)

⑤ **[Compression] buttons**

[H.264]/[MPEG-4] button: The letters "H.264" (or "MPEG-4") will turn green and an H.264 (or MPEG-4) image will be displayed. When "On" is selected for "H.264 transmission" (or "MPEG-4 transmission") of "H.264(1)" (or "MPEG-4(1)"), the [H.264] (or [MPEG-4]) button will be displayed. (☞ Pages 34 and 37)

[JPEG] button: The letters "JPEG" will turn green and JPEG image will be displayed.

⑥ **[Image capture size] buttons**

These buttons will be displayed only when a JPEG image is displayed.

[VGA] button: The letters "VGA" will turn green and images in the main area will be displayed in VGA size.

[QVGA] button: The letters "QVGA" will turn green and images in the main area will be displayed in QVGA size.

⑦ **[AUX] buttons (*2)**

[AUX] button will become available only when "AUX output" is selected for "Terminal 3" on the setup menu. (☞ Page 45)

[Open] button: The letters "Open" will turn green and the status of AUX connector will be open.

[Close] button: The letters "Close" will turn green and the status of the AUX connector will be closed.

⑧ **[Rec. on SD] button (*2)**

This button will be displayed only when "Manual" is selected for "Save trigger" on the setup menu. (☞ Page 31)

Click this button to manually record images on the SD memory card. Refer to page 12 for descriptions of how to manually record images on the SD memory card.

⑨ **[Log] button (*1)**

[List] button will be displayed only when "On" is selected for "Save logs" on the setup menu. (☞ page 33) When this button is clicked, the log list will be displayed and images saved on the SD memory card can be played. Refer to pages 17 to 20 for further information about the log list and for how to play images on the SD memory card.

⑩ **[Zoom] buttons (*2)**



: Click this button to adjust the zoom ratio to the WIDE side.

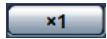

: Click this button to set the zoom ratio to x1.



: Click this button to adjust the zoom ratio to the TELE side.

⑪ **[Focus] buttons (*2)**

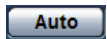

: Click this button to adjust the focus automatically.

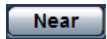

: Click this button to adjust the focus to the "Near" side.

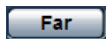

: Click this button to adjust the focus to the "Far" side.

⑫ **Auto mode (*2)**

Select an operation from the pull-down menu and click the [Start] button. The selected operation will start.

Click the [Stop] button to stop the operation.

The selected operation will stop when the camera (panning/tilting/zooming/focusing) is operated.

Auto track: Performs auto track when the camera supports auto track (AUTO TRACK).

Auto pan: Automatically pans between the start position and the end position set in advance.

Even when the camera is operated for zooming or focusing, the camera continues panning.

Preset position sequence: Automatically moves to the preset positions orderly (start from the lowest preset position number).

Patrol 1-4: Operates the camera in accordance with patrol function settings.

Note:

- To check if the camera supports auto track, refer to the operating instructions of the camera.
 - To activate auto pan, sort, preset position sequence or patrol 1-4, it is required to perform the settings on the setup menu of camera in advance. (☞ Page 41)
 - While a camera controlled via the RS-485 communication interface is executing a patrol function, it is impossible to start another one. Stop the current patrol function before starting a new one.
-

⑬ **Control pad/buttons (*2)**

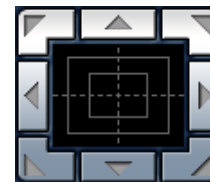

: Left-click on the control pad to adjust the horizontal/vertical position of the camera (panning/tilting).

Panning/tilting speed will be faster if a clicked point gets farther from the center point of the control pad.

It is also possible to pan/tilt the camera by dragging the mouse. Zoom and focus can be adjusted by right-clicking. When an upper/lower area of the control pad is right-clicked, the displayed image will be zoomed in/out on. When a left/right area is right-clicked, the focus will be adjusted to the Near/Far side.

⑭ **[Brightness] buttons (*2)**



: The displayed image will be darker.

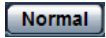

: The adjusted brightness will return to the default brightness.

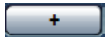

: Image will be brighter.

Note:

- When the [Brightness] buttons are clicked while the camera is at the preset position, the adjusted brightness will automatically be registered for the current preset position.

⑮ **Preset (*2)**

Select a preset position from the pull-down menu and click the [Go] button. The camera will move to the selected preset position. When "Home" is selected, the camera will move to the home position. To activate preset positions and home position, it is required to configure the settings on the SETUP MENU of camera in advance. (☞ Page 41)

⑯ **Unit title**

The unit title entered for "Unit title" on the [Basic] tab will be displayed. (☞ Page 30)

⑰ **Camera title**

The camera title entered for "Camera title" on the [Basic] tab will be displayed. (☞ Page 30)

⑱ **[Alarm occurrence indication] button (*2)**

This button will be displayed at an alarm occurrence, and the channel of alarm occurrence (one of ① to ④ buttons) will light. When the button is clicked, the button will disappear and the alarm output connector will be reset. (☞ Page 13)

⑲ **[Full screen] button**

Images will be displayed on a full screen. To return to the "Live" page, press the [Esc] key.

⑳ **[One shot] button**

Click this button to take a picture (a still picture). The picture will be displayed on a newly opened window. When right-clicking on the displayed image, the pop-up menu will be displayed. It is possible to save the image on the PC by selecting "Save" from the displayed pop-up menu. When "Print" is selected, printer output is enabled.

㉑ **[Mic input] button (*3)**

Turns on/off the audio reception (hear audio from the unit on a PC).

This button will be displayed only when "Mic input", "Interactive(Half-duplex)" or "Interactive(Full-duplex)" is selected for "Audio transmission/reception" on the setup menu. (☞ Page 41)

When this button is clicked, the button will turn into the button and audio from the unit will not be heard. Audio volume can be adjusted (Low/Middle/High) by moving the volume cursor .

Note:

- Mic input is available on Ch1 only.

㉒ **[Audio output] button (*3)**

Turns on/off the audio transmission (play audio from the PC on the unit speaker).

This button will be displayed only when "Audio output", "Interactive(Half-duplex)" or "Interactive(Full-duplex)" is selected for "Audio transmission/reception" on the setup menu. (☞ Page 41)

The button will blink during the audio transmission. When this button is clicked, the button will turn into the button and audio from the unit will not be heard. Audio volume can be adjusted (Low/Middle/High) by moving the volume cursor .

Note:

- Audio output is available on Ch1 only.
- When a user is using the audio transmission function with "Interactive(Half-duplex)" selected, the [Mic input] button and the [Audio output] button will be inoperable for the other users. When "Interactive(Full-duplex)" is selected, the transmission button is inoperable for other users.
- Possible duration of audio transmission is up to 5 minutes per transmission. When 5 minutes have passed, audio transmission will automatically stop. To turn the audio transmission function on, click the [Audio output] button again.
- When the unit is restarted, the adjusted volume level (for both the audio transmission and reception) will return to the level that had been set on the [Audio] tab on the setup menu. (☞ Page 41)
- Actual volume level will change in three steps even though the volume cursor can be adjusted minutely.

②③ **SD recording status indicator**

The status of the SD recording can be checked with this indicator.

When the SD recording starts, this indicator will light red. When the SD recording stops, this indicator will go off.

This indicator will be displayed only when "Manual" is selected for "Save trigger" on the setup menu.

(☞ Page 31)

②④ **Main area**

Images from the camera will be displayed in this area.

The current time and date will be displayed according to the settings configured for "Time display format" and "Date/time display format". (☞ Page 30)

Click a desired point in the main area on the "Live" page that is to be the center of the angle of view.

The camera moves to adjust the position in order to set the clicked point as the center.

- *1 Only operable by users whose access level is "1. Administrator"
- *2 Only operable by users whose access level is "1. Administrator" or "2. Camera control" when "On" is selected for "User auth." (☞ page 50).
- *3 Operable by users who belong to the access level selected for "Permission level of audio trans./recep." on the [Audio] tab of the "Image/Audio" page. Refer to page 50 for further information about the access level.

Note:

- When operated by a lower access level user, images displayed on the screen may be changed temporarily. This does not affect operation of the camera.
-

Monitor images from multiple cameras

Images from multiple cameras can be displayed on a multi-screen. Images from 4 cameras (up to 16 cameras) can be displayed simultaneously. To display images on a multi-screen, it is necessary to register cameras in advance. 4 cameras can be registered as a group and up to 4 groups (16 cameras) can be registered. (Page 44)

Important:

- When displaying images on a 16-screen, panning, tilting and zooming operations become unavailable for images from the Panasonic PTZ cameras.
- When displaying images on a 4-screen, panning, tilting and zooming operations become available only for images from the Panasonic PTZ cameras. Refer to the readme file on the provided CD-ROM for further information about the compatible PTZ cameras and their versions.
- Only JPEG images can be displayed on a multi-screen.
- Audio will not be heard.
- When the power is turned off or the Ethernet cable is disconnected while displaying images, displaying images on a multi-screen from the "Live" page will become unavailable.
- Regardless of the settings of the registered device, the images will be displayed altered to the aspect ratio of 4:3 on a multi-screen.

Step1

Click the desired [Multi-screen] button.

→ Images from the registered cameras will be displayed on a selected multi-screen (screen can be split up to 16 areas). The following are instructions when displaying on a 4-split screen.

- ① To display images on a single screen, click the [Live] button or one of the buttons [1] to [4].
- ② Click a camera title. Live images from the camera corresponding to the clicked camera title will be displayed on the "Live" page of the newly opened window.

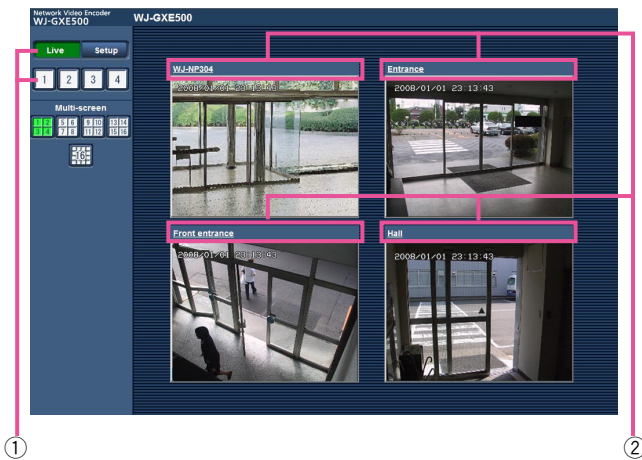

Record images on the SD memory card manually

Images displayed on the "Live" page can be recorded on the SD memory card manually.

This button is operable only when "Manual" is selected for "Save trigger" on the setup menu. (☞ Page 31)

Images recorded on the SD memory card can be copied onto the PC. (☞ Page 19)

Step 1

Display the "Live" page. (☞ Page 5)



Step 2

Click the [SD] button in the "Rec. on SD" box.

→ The SD recording window will open.



Step 3

Click the [Start] button to start recording images on the SD memory card.

The SD recording status indicator will light red while images are being recorded on the SD memory card.

(☞ Page 7)

→ The save interval (frame rate) can be configured on the [SD memory card] tab of the "Basic" page.

(☞ Page 31)

Step 4

Click the [Stop] button to stop saving images on the SD memory card.

Step 5

Click the [Close] button to close the window.

Note:

- The destination directory to which data are to be saved will be a fixed directory on Drive B. Refer to the "Directory structure of drive B" section (☞ page 72).

It is possible to obtain image data saved on Drive B by clicking the [Execute] button of "Access img." on the [SD memory card] tab and by logging in the unit to access images from the user authentication window.

Action at an alarm occurrence

The alarm action (action at an alarm occurrence) will be performed when the following alarms occur.

Alarm type

Terminal alarm: When connecting an alarm device such as a sensor to the EXT I/O terminals of the unit, the alarm action will be performed when the connected alarm device is activated. (☞ Page 45)

VMD alarm: When motion is detected in the set VMD area, the alarm action will be performed. (☞ Page 45)
* VMD stands for "Video Motion Detection".

Command alarm: When a Panasonic alarm protocol is received from the connected device via a network, the alarm action will be performed. (☞ Page 45)

Camera site alarm: When a camera connected to a Video input connector detects an alarm by alarm sensors or cameras' motion detectors, etc., and the unit receives the alarm input signal from the camera, the alarm action will be performed. (☞ Page 45)

Video loss: When the loss of video input signals is detected due to coaxial cable disconnections or camera troubles, the alarm action will be performed. (☞ Page 45)

Action at an alarm occurrence

- **Display the [Alarm occurrence indication] button on the "Live" page.** (☞ Page 7)

The alarm occurrence indication button will be displayed on the "Live" page at an alarm occurrence.

Important:

- When "Polling (30 sec)" is selected for "Alarm status update mode" (☞ page 30), the [Alarm occurrence indication] button will be refreshed in 30-second intervals. For this reason, it may take a maximum of 30 seconds until the [Alarm occurrence indication] button is displayed on the "Live" page at an alarm occurrence.

-
- **Notify of alarm occurrences to the device connected to the alarm connector**

It is possible to output signals from the alarm connector on the rear of the unit and sound the buzzer when an alarm occurs.

The settings for the alarm output can be configured on the [Alarm] tab of the "Alarm" page. (☞ Page 45)

- **Save images on the SD memory card**

When an alarm occurs, images will be saved on the SD memory card. The settings to save images on the SD memory card can be configured on the [SD memory card] tab of the "Basic" page. (☞ Page 31)

- **Transmit an image onto a server automatically**

An alarm image can be transmitted at an alarm occurrence to the server designated in advance. The settings required to transmit an alarm image to a server can be configured on the [Alarm] tab of the "Alarm" page and the [FTP] tab of the "Server" page (☞ pages 45 and 52).

Important:

- Select "FTP error" for "Save trigger" on the [SD memory card] tab when using the SD memory card. When "Alarm input" or "Manual" is selected for "Save trigger", an alarm image will not be transmitted at an alarm occurrence to the FTP server. (☞ Page 31)
-

- **Notify of alarm occurrences by e-mail**

Alarm mail (alarm occurrence notification) can be sent at an alarm occurrence to the e-mail addresses registered in advance.

The settings for alarm mail can be configured in the "Mail notification" section of the [Notification] tab of the "Alarm" page and the [Mail] tab of the "Server" page (☞ pages 48 and 52).

- **Notify of alarm occurrences to the designated IP addresses (Panasonic alarm protocol notification)**

This function is available only when a Panasonic device, such as the network disk recorder, is connected to the system. When "On" is selected for "Panasonic alarm protocol notification", the connected Panasonic device will be notified that the unit is in the alarm state. The settings for Panasonic alarm protocol can be configured in the Panasonic alarm protocol section of the [Notification] tab of the "Alarm" page. (☞ Page 48)

Transmit images onto an FTP server

Images can be transmitted to an FTP server. By configuring the following settings, transmission of images captured at an alarm occurrence or captured at a designated interval to an FTP server will become available.

Important:

- When using this function, set the user name and the password to access the FTP server to restrict users who can log into the FTP server.
 - To transmit images to the FTP server, select "Not use" for "SD memory card", or select "FTP error" for "Save trigger" on the [SD memory card] tab of the "Basic" page. (☞ Page 31)
-

Transmit an alarm image at an alarm occurrence (Alarm image transmission)

An alarm image can be transmitted at an alarm occurrence to the FTP server. To transmit alarm images to an FTP server, it is necessary to configure the settings in advance.

The settings for the FTP server can be configured on the [FTP] tab of the "Server" page. (☞ Page 52)

The alarm image transmission function can be turned on/off on the [Alarm] tab of the "Alarm" page. (☞ Page 45)

Note:

- Depending on the network traffic, the number of the transmitted images may not reach the set number of images to be transmitted.
 - Alarm images failed to be transmitted to the FTP server at an alarm occurrence will not be saved on the SD memory card.
-

Transmit images at a designated interval or period (FTP periodic image transmission)

Images can be transmitted at a designated interval or period. To transmit images at a designated interval or period, it is necessary to configure the settings in advance.

The settings for the FTP server can be configured on the [FTP] tab of the "Server" page. (☞ Page 52)

It is possible to determine whether or not to use the FTP periodic image transmission function and to configure the settings relating to alarm images and the schedule on the [FTP img. trans.] tab of the "Network" page. (☞ Page 56)

Note:

- Depending on the line speed or the traffic, images may not be transmitted at the designated interval.
 - When "On" is selected for both the alarm image transmission function and the FTP periodic image transmission function, the alarm image transmission function will be given priority over the FTP periodic image transmission function. Therefore, images may not be transmitted at the interval designated on the "FTP periodic image transmission" setting.
-

Save images on the SD memory card when images have failed to be transmitted using the FTP periodic image transmission function

Images that have failed to be transmitted using the FTP periodic image transmission can be saved automatically on the SD memory card. Images saved on the SD memory card can be obtained from the [SD memory card] tab of the "Basic" page. (☞ Page 31)

To use the SD memory recording function featured in Panasonic's network disk recorder, select "Off" for "FTP periodic image transmission" (☞ page 56) and "FTP error" for "Save trigger" (☞ page 31).

We make no guarantee for any damages of files on the SD memory card incurred by malfunction or error occurrence in files saved in the SD memory card regardless of what the cause may be.

Note:

- Depending on the settings and status of use, not all images failed in the FTP periodic transmission may not be saved on the SD memory card.
-

Display the log list

The logs will be displayed in the following list forms.

- Alarm log: Logs of the alarm occurrences such as time and date of the alarm occurrences and the alarm type will be displayed.
- Manual log: Logs filed when images have been manually recorded on the SD memory card will be displayed.
- FTP trans. error log: Logs filed when the FTP periodic image transmission function has failed will be displayed.

Each log list can be displayed only when "On" is selected for "Save logs" on the [Log] tab of the "Basic" page (Page 33) respectively.

Step 1

Display the "Live" page. (Page 5)



Step 2

Click the [List] button.

→ The log list will be displayed in a newly opened window (log list window).

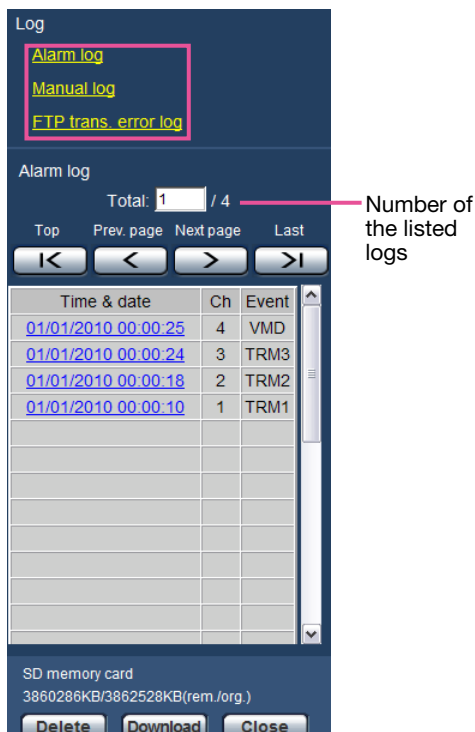

Important:

- Only a single user can operate the log list window. Other users cannot access the log list window.

Note:

- When "Not use" is selected for "SD memory card", the error log list of manual saving and the FTP periodic image transmission function will not be displayed.

Step 3

Click the desired log type listed below "Log" to display the log list.

→ The log list of the selected log type will be displayed.

Note:

- When saved images are on the SD memory card, clicking the time and date of the alarm occurrence will display the respective images. (Page 19)

About the log list window

[Number of the listed logs]

Total number of the logs of the selected log type and a number of the log being displayed on the top of the log list will be displayed.

Note:

- Enter the desired log number and press the [Enter] key on the keyboard. The log of the designated number will be displayed on the top of the log list.

[Top] button

Click this button to display the log listed at the top.

[Prev. page] button

Click this button to display the previous page of the log list.

Note:

- When the mouse button is held down while placing the mouse pointer on the [Prev. page] button, the displayed log number will be decremented. When the mouse button is released, the decrement of the log number will stop and the log number displayed at the moment when the mouse button is released will be the top of the currently displayed page.
-

[Next page] button

Click this button to display the next page of the log list.

Note:

- When the mouse button is held down while placing the mouse pointer on the [Next page] button, the displayed log number will be incremented. When the mouse button is released, the decrement of the log number will stop and the log number displayed at the moment when the mouse button is released will be the top of the currently displayed page.
-

[Last] button

Click this button to display the log listed at the bottom.

[Time & date]

Time and date when each log has been filed will be displayed.

Note:

- When "Off" is selected for "Time display format" (☞ page 30), time and date of alarm occurrence will be displayed in 24-hour format.
 - The recording timing of logs are as follows.
 - Alarm log:** Alarm occurrence time and date will be filed as a log.
 - Manual log:** Time and date when recording of images onto the SD memory card started will be filed as a log. When recording are performed sequentially, logs will be filed every one hour.
 - FTP trans. error log:** Logs will be filed every one hour.
-

[Ch]

The channel will be displayed.

[Event]

The event type will be displayed.

The event types will be displayed only when displaying the alarm log list.

TRM1: Alarm by alarm input to Terminal 1

TRM2: Alarm by alarm input to Terminal 2

TRM3: Alarm by alarm input to Terminal 3

VMD: Alarm by VMD alarm

COM: Alarm by command alarm

CAM: Alarm by camera site alarm

LOSS: Alarm at a video loss occurrence

[SD memory card]

Available capacity and the original capacity of the SD memory card will be displayed.

The displayed descriptions are the same descriptions displayed as "Remaining capacity" on the [SD memory card] tab. (☞ Page 31)

[Delete] button

Click this button to delete the currently displayed log list.

When using the SD memory card, images associated with the log list will also be deleted.

Important:

- When many images are saved on the SD memory card, it will take some time to complete the deletion.
- In the process of the deletion, only logs will be saved, and it is impossible to save images newly.
- Do not turn off the power of the unit until the deletion is complete.

When the power of the unit is turned off in the process of the deletion, some images may remain on the SD memory card.

In this case, click the [Delete] button on the same log list window used to delete the logs.

[Download] button

Click this button to download all logs of the selected log list as a file onto the PC.

[Close] button

Click this button to close the log list window.

Playback of images on the SD memory card

When clicking a time and date listed on the log list window, the "Live" page will turn to the "Playback" page. When images associated with the clicked time and date are on the SD memory card, the first image of them will be displayed.

Important:

- Refresh interval of images may become slow during playback or download.
- When many images are saved on the SD memory card, it may take time to display images on the "Playback" page.
- Even when the size of the images saved on the SD memory card is "QVGA", the images will be played in VGA size on the "Playback" page. Therefore, images may look coarse on the "Playback" window.
- When playing images by selecting an FTP error log on the log list, images may not be played in order of images recorded on the SD memory card if they have been recorded on the SD memory card with selected value for the "Transmission interval" setting on the [FTP img. trans.] tab is "1 min" or less. (☞ Page 56)

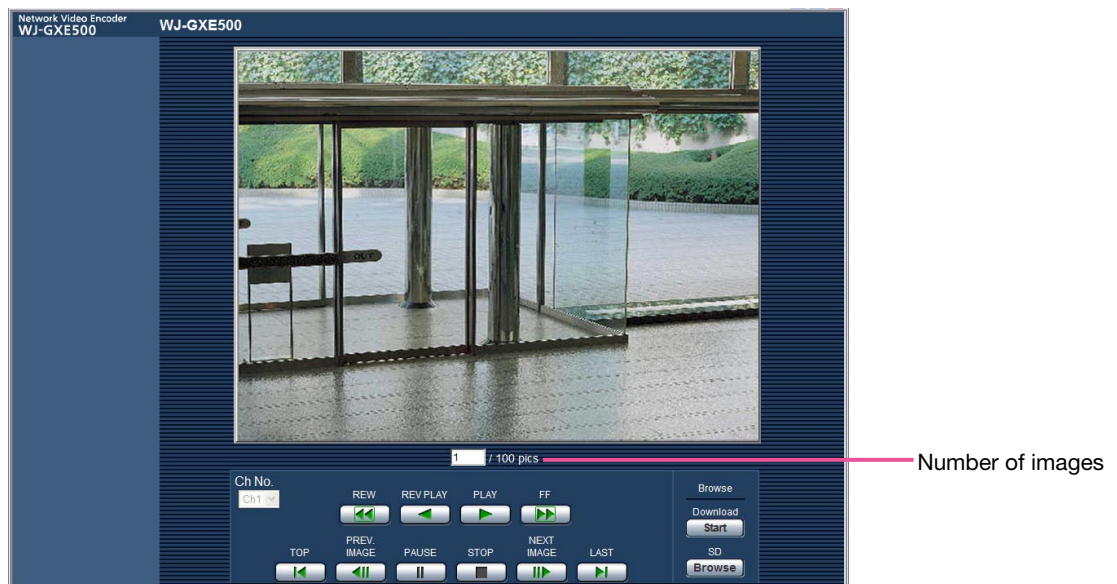

About the playback page

Number of images

When clicking a time and date listed on the log list window, total number of images associated with the clicked time and date, and the number of the currently displayed image will be displayed.

Note:

- Enter the desired number of image and press the [Enter] key on the keyboard. The image of the designated number will be displayed.

[Ch No.]

Select the channel number to play back images from the "FTP trans. error log" list.

[REW] button

When this button is clicked, images will be played at high speed in reverse sequential order.

Each time the button is clicked, the playback speed will change.

When the [PLAY] button or the [REV PLAY] button is clicked during fast playback/fast reverse playback, playback speed will return to the normal playback speed.

[REV PLAY] button

Images will be played in reverse sequential order.

[PLAY] button

Images will be played in sequential order.

[FF] button

When this button is clicked, images will be played at high speed in sequential order. Each time the button is clicked, the playback speed will change. When the [PLAY] button or the [REV PLAY] button is clicked during fast playback/fast reverse playback, playback speed will return to the normal playback speed.

[TOP] button

The first image will be displayed.

[PREV. IMAGE] button

The previous frame will be displayed and paused when this button is clicked during playback. Each time this button is clicked during pausing, the frame previous to the currently displayed frame will be displayed.

Note:

- When the mouse button is being held while placing the mouse pointer on this button, the displayed image number will be decremented. When the mouse button is released, the decrementing of the image number will stop and the image corresponding to the currently displayed number will be displayed.

[PAUSE] button

Playback will be paused when this button is clicked during playback. Playback will resume when this button is clicked during pausing.

[STOP] button

Playback will stop and the "Playback" window will turn to the "Live" page.

[NEXT IMAGE] button

The next frame will be displayed and paused when this button is clicked during playback. Each time this button is clicked during pausing, the frame next to the currently displayed frame will be displayed.

Note:

- When the mouse button is held down while the mouse pointer is on this button, the image number will be incremented.

When the mouse button is released, the increment of the image number will stop and the image number displayed at the moment when the mouse button is released will be displayed.

[LAST] button

The last image will be displayed.

■ Browse

[Start] button

The selected image will be downloaded onto the PC. Before downloading images, designate the destination directory in advance. (Page 33) The following window will be displayed when the [Start] button is clicked. Select the image to be downloaded, and then click the [OK] button.

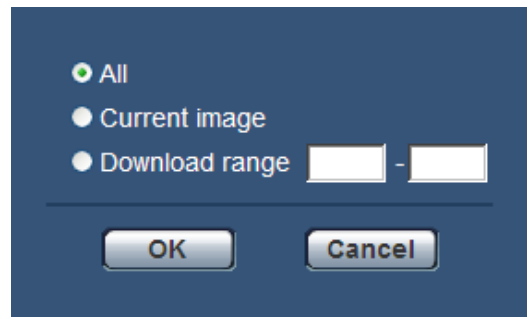

All: All images saved at the selected time and date will be downloaded.

Current image: Only the currently displayed image will be downloaded.

Download range: Images in the designated range of number of images will be downloaded.

Note:

- When downloading images from the "FTP trans. error log" list, only images from the channels selected for "Ch No." are available.
- When the [Cancel] button is clicked in the process of the download, the download will be canceled. In this case, images already downloaded before clicking the [Cancel] button will be saved on the PC.

[Browse] button

When successfully logged in after the user authentication process, a folder on the SD memory card in which images are saved will be displayed.

Maintenance of the unit [Maintenance]

Check the system log [System log]

It is possible to check the system log on the [System log] tab of the "Maintenance" page on the setup menu.

Up to 4 000 system logs can be saved on the SD memory card when the SD memory card is inserted after selecting "Use" for "SD memory card" on the [SD memory card] tab (☞ page 31).

When "Not use" is selected for "SD memory card", up to 100 system logs can be saved on the built-in memory of the unit.

When the saved system logs have reached the maximum number, the newer logs will overwrite the older system logs. In this case, the oldest log is the first to be overwritten.

The system logs will be displayed in group of 100 logs each.

When using the SD memory card, the logs will be saved even when the power of this unit is turned off. When not using the SD memory card, the logs will be deleted when the power of this unit is turned off.

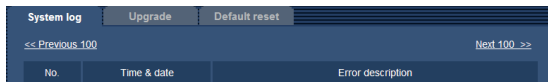

[Next 100 >>]

When clicking "Next 100 >>", the next 100 system logs will be displayed.

[<< Previous 100]

When clicking "<< Previous 100", the previous 100 system logs will be displayed.

[No.]

The serial number of the system log will be displayed.

[Time & date]

Time and date at the error occurrence will be displayed.

Note:

- When "Off" is selected for "Time display format" on the [Basic] tab (☞ page 30), time & date of logs will be displayed in 24-hour format.
-

[Error description]

The descriptions about the error will be displayed.

Refer to page 58 for further information about the system logs.

Upgrade the firmware [Upgrade]

It is possible to upgrade firmware on the [Upgrade] tab of the "Maintenance" page on the setup menu. The current firmware of this unit can be checked and upgraded to the latest version on this page.

Contact the dealer for further information about the firmware upgrade.



[Model no.], [MAC address], [Serial no.], [Firmware version], [IPL version], [HTML version], [IP address(IPv6)], [Viewer software installation counter]

Information of each item will be displayed.

Step 1

Contact the dealer and download the latest firmware onto a PC.

Important:

- A blank (space) cannot be used for the name of the directory where the downloaded firmware to be saved.

Step 2

Click the [Browse...] button and designate the downloaded firmware.

Step 3

Click the radio button respective to the desired option to determine whether or not to initialize the settings after completing the firmware upgrade.

Note:

- Refer to the readme file provided with the firmware first and determine whether or not to initialize the settings after the firmware upgrade.

Step 4

Click the [Execute] button.

- The confirmation window will be displayed. When "Do not reset the settings to the default after the upgrade." is selected, the confirmation window will not be displayed.

Important:

- Before starting the upgrade, select "Off" for "FTP periodic image transmission" on the [FTP img. trans.] tab of the "Network" page. (☞ Page 56)
- After completing the upgrade, be sure to delete temporary internet files. (☞ Page 64)
- Upgrade the firmware using a PC in the same subnet as the unit.
- Follow the instructions from the dealer when upgrading the firmware.
- Use the designated file (extension: img) for the firmware upgrade.
- The name of the firmware to be used for the upgrade should be "gxe500_xxxxx.img".
* ("xxxxx" indicates the version of the firmware.)
- Do not turn off the power of the unit during the upgrade process.
- Do not perform any operation during upgrading and wait until it completes.
- The following network settings will not be reset when upgrading the firmware after selecting "Reset the settings to the default after completing the upgrade. (Except the network settings)".
On/Off for DHCP, IP address, subnet mask, default gateway, HTTP port, line speed, bandwidth control (bit rate), time & date
- The viewer software used on each PC should be licensed individually. Refer to your dealer for the software licensing.

Reset the settings/Reboot the unit [Default reset]

It is possible to reset the settings or reboot the unit on the [Default reset] tab of the "Maintenance" page on the setup menu.

The settings and the HTML data of the unit can be initialized and reboot of the camera and the unit can be performed on this page.



[Reset to the default (Except the network settings)]

Click the [Execute] button to reset the settings of the unit and RS-485 command table to the default. Note that the network settings will not be reset.

It is impossible to operate the unit for around 2 minutes after the initialization.

Note:

- The following network settings will not be reset.
On/Off for DHCP, IP address, subnet mask, default gateway, HTTP port, line speed, bandwidth control (bit rate), time & date
-

[Load the default HTML files (setup menu).]

Click the [Execute] button to reset the settings of the unit, RS-485 command table and HTML file to the default. Note that the network settings will not be reset. It is impossible to operate the unit for around 2 minutes after the initialization.

[Reset to the default and load the default HTML files.]

Click the [Execute] button to reset the settings of the unit, RS-485 command table and HTML file to the default. Note that the network settings will not be reset. It is impossible to operate the unit for around 5 minutes after the initialization.

Note:

- The following network settings will not be reset.
On/Off for DHCP, IP address, subnet mask, default gateway, HTTP port, line speed, bandwidth control (bit rate), time & date
-

[Camera restart]

Click the [Execute] button to restart all the cameras connected to the unit. After restart, it is impossible to control the camera around 1 minute.

[Unit restart]

Click the [Execute] button to reboot the unit.

The unit will be inoperable for around 2 minutes after the restart just as when the power is turned on.

Note:

- To initialize the network settings (☞ page 54), turn off the power of the unit, then turn on the power again while holding down the [INITIAL SET] button on the unit for 5 seconds. Wait around 2 minutes after releasing the button. The unit will start up and the settings including the network settings will be initialized.
Do not turn off the power of the unit until the initialization is complete and the SDHC/SD memory card error LED lights up.
 - The notification function allows users to provide the notification of the error to the specified mail address and an original alarm destination when an error such as no SD memory card insertion after the reboot or a locked SD memory card insertion occurs. (☞ Page 48)
-

Viewing Help

If you want to know anything about operation or setup methods on screen, display the "Help" screen.

Displaying the Help screen

Step 1

Click the [Setup] button.

→ The setup screen is displayed.

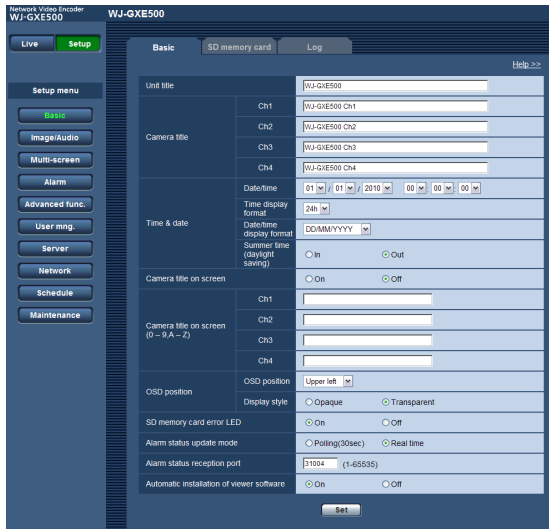

Step 2

Click "Help >>".

→ The "Help" screen is displayed.

Note:

- As for the "Help" page, only English version is available.

1-1-Basic	
Menu	Setup data
Unit title *1, *2	(default: WJ-GXE500)
Camera title	Ch1 *1, *2 (default: WJ-GXE500 Ch1)
	Ch2 *1, *2 (default: WJ-GXE500 Ch2)
	Ch3 *1, *2 (default: WJ-GXE500 Ch3)
	Ch4 *1, *2 (default: WJ-GXE500 Ch4)
Time & date	Date/Time *3 2010/01/01 00:00:00 - 2035/12/31 23:59:59
	Time display format 12h / 24h / Off
	Date/Time display format DD/MM/YYYY (Default for the PAL model)
	MM/DD/YYYY
	YYYY/MM/DD
Summer time (daylight saving) Mmm/DD/YYYY (Default for the NTSC model)	
Summer time (daylight saving) In / Out	
Camera title on screen	On / Off
Camera title on screen (0 - 9 A - Z)	Ch1 - Ch4 *4, *5 (default: blank)
OSD position	OSD position Upper left / Lower left / Upper right / Lower right
	Display style Opaque / Transparent
SD memory card error LED	On / Off
Alarm status update mode	Polling(30sec) / Real time
Alarm status reception port	*1004 (1-65535)
Automatic installation of viewer software	On / Off

*1 Number of characters: 0 - 20 characters
*2 Unavailable characters: * &
*3 The default time & date is calculated based on the manufacture date & time.
*4 Number of characters: 0 - 16 characters
*5 Available characters: 0 - 9, A - Z and the following marks.
! * # \$ % & ' () * + , - . / : ; = ?
*6 When "On" is selected, the SD memory card error LED will light when data cannot be saved on the SD memory card.
*7 Select the interval to refresh the alarm occurrence indication button, the [AUX] buttons and the SD recording status indicator on the "Live" page.
*8 Depending on the network environment, notification may not be provided in real time.
*9 The following port numbers are unavailable since they are already in use.
20, 21, 23, 25, 42, 53, 67, 68, 69, 80, 110, 123, 161, 162, 995, 10669, 10670
*10 It is impossible to display images and to receive/transmit audio between the unit and the PC when the viewer software "Network Camera View4" is not installed on the PC.

[Go to page top](#)

Display the setup menu from a PC

The settings of the unit can be configured on the setup menu.

Important:

- The setup menu is only operable by users whose access level is "1. Administrator". Refer to page 50 for how to configure the access level.

How to display the setup menu

Step 1

Display the "Live" page. (☞ Page 5)

Step 2

Click the [Setup] button on the "Live" page.

→ The window with the user name and password entry fields will be displayed.

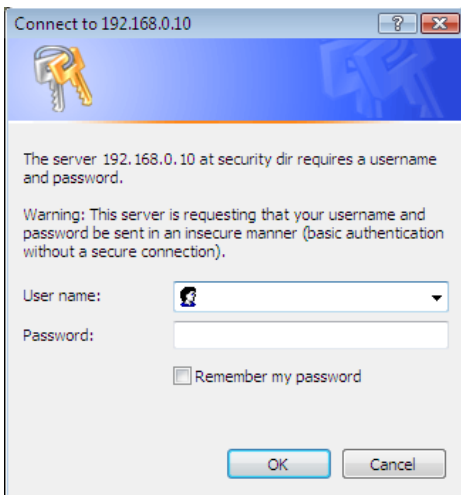

Step 3

Click the [OK] button after entering the user name and the password.

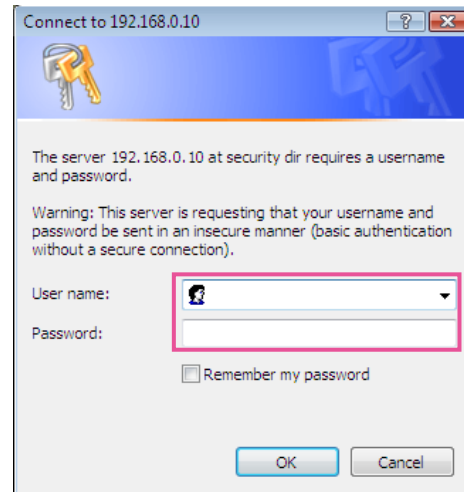

→ The setup menu will be displayed.

Refer to page 28 for further information about this menu.

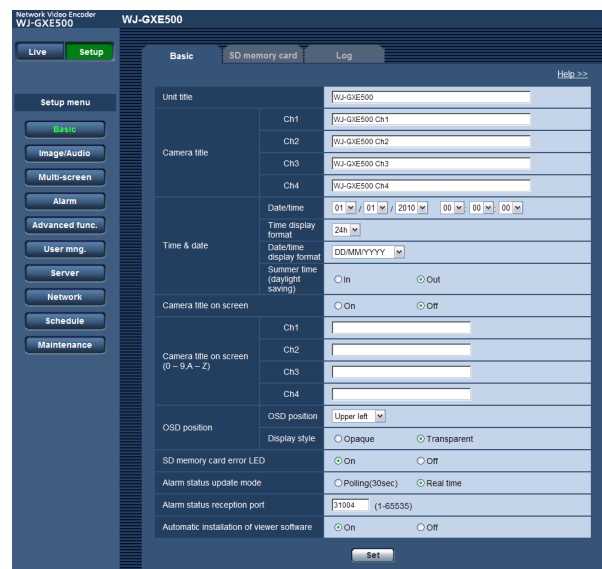

How to operate the setup menu

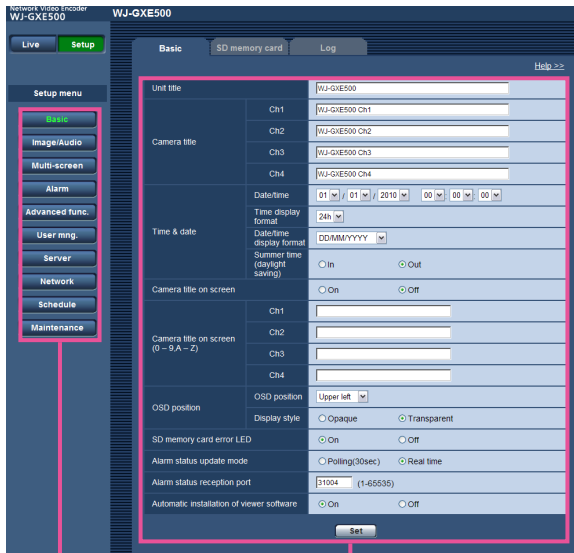

Menu buttons

Setup page

Step 1

Click the desired button in the frame on the left of the window to display the respective setup menu. When there are tabs at the top of the setup page displayed in the frame on the right of the window, click the desired tab to display and configure the setting items relating to the name of the tab.

Step 2

Complete each setting item displayed in the frame on the right of the window.

Step 3

After completing each setting item, click the [Set] button to apply them.

Important:

- When there are two or more [Set] and [Execute] buttons on the page, click the respective button to the edited setting item.

<Example>



When completing the setting items in field A, click the [Set] button (A-1) below field (A).

The edited settings in field A will not be applied unless the [Set] button (A-1) is clicked.

About the setup menu window

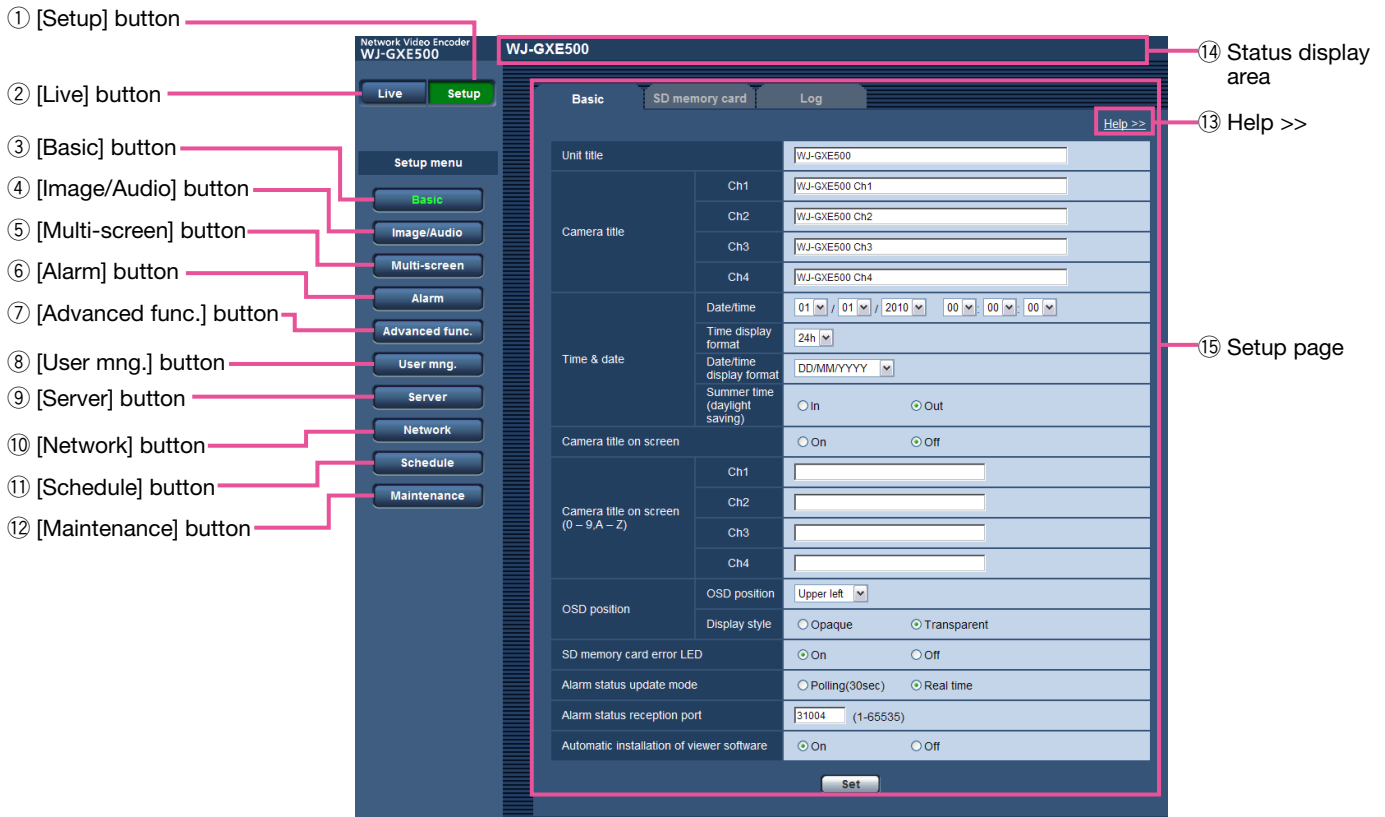

① **[Setup] button**
Display the "Setup" page.

② **[Live] button**
Display the "Live" page.

③ **[Basic] button to ⑫ [Maintenance] button**
When one of these buttons is clicked, the corresponding setup page will be displayed. (☞ Page 28)

⑬ **Help >>**
Display the "Help" page. (☞ Page 24)

Note:

- As for the "Help" page, only English version is available.
- Information such as available characters and setting values for the setting items on each tab is described.

⑭ **Status display area**
The name of the unit whose settings currently being configured will be displayed.
In addition, when an alarm occurs while the [VMD area] tab is being displayed, the alarm occurrence indication button will be displayed.

⑮ **Setup page**
Pages of each setup menu will be displayed. There are tabs for some setup menus.

Setup menu and its items

The setup menu consists of the following menus and tabs.

Menu page	Tab	Outline	Reference page
Basic	Basic	Configure the basic settings such as time & date and camera titles.	30
	SD memory card	Configure the operation specifications to save images on the SD memory card.	31
	Log	Configure the settings to save the "Alarm log" list, "Manual log" list and "FTP trans. error log" list.	33
Image/Audio	JPEG/H.264	[JPEG/H.264] tab will be displayed when "H.264" is selected for "Video encoding format". Configure the settings relating to JPEG images such as "Image capture size", "Image quality" and H.264 images such as "Max bit rate (per client)", "Image capture size", "Image quality", etc. in this section.	34
	JPEG/MPEG-4	The [JPEG/MPEG-4] tab will be displayed when "MPEG-4" is selected for "Video encoding format". Configure the settings relating to JPEG images such as "Image capture size", "Image quality" and MPEG-4 images such as "Max bit rate (per client)", "Image capture size", "Image quality", etc. in this section.	37
	Image/Position	The setup menu of camera is displayed. Configure the settings relating to camera operations using the operation panel. Refer to the operating instructions of camera for further information about the settings.	40
	Audio	Configure relating to the settings relating to audio.	41
	Coaxial/RS-485	Configure the settings relating to the video synchronization type, camera control, cable compensation and RS-485 communication.	42
	Multi-screen	Multi-screen setup	Register the cameras from which images are to be displayed on a multi-screen.
Alarm	Alarm	Configure the settings relating to alarm actions, alarm images to be transmitted to an FTP server and alarm output terminals. In addition, the name for "AUX" on the "Live" page can be changed.	45
	VMD area	Configure the video motion detection areas.	46
	Notification	Configure the settings relating to the alarm mail and Panasonic alarm protocol.	48
Advanced func.	XML notification	Configure the settings relating to the XML notification that notifies the server or others of face detection information in the XML format.	49
	Face detection	Configure the settings relating to displaying of the frame to be used for the face detection and the settings relating to image attachment to the face detection information.	49

Menu page	Tab	Outline	Reference page
User mng.	User auth.	Configure the settings relating to the user authentication.	50
	Host auth.	Configure the restriction settings of PCs (IP address) from accessing the unit.	50
	System	Configure the settings relating to the priority stream that can transmit images without deteriorating the image quality and refresh interval even when multiple users access concurrently.	51
Server	Mail	Configure the settings relating to the mail server used to send the alarm mail.	52
	FTP	Configure the settings relating to the FTP server used to transmit the alarm images.	52
	NTP	Configure the settings relating to the NTP server such as the NTP server address, port number, etc.	53
Network	Network	Configure the network settings. The following information is required to configure the network settings. Contact the network administrator or your Internet service provider. <ul style="list-style-type: none"> • IP address • Subnet mask • Default gateway (when using the gateway server/router) • HTTP port • Primary DNS address 	54
	DDNS	Configure the settings relating to DDNS. To use the DDNS function, it is necessary to connect to the dedicated DDNS server.	55
	SNMP	Configure the settings relating to SNMP. It is possible to check the status of the unit by connecting to the SNMP manager. When using the SNMP function, contact the network administrator.	56
	FTP img. trans.	Configure the settings relating to the periodic transmission of images to an FTP server. To transmit images to an FTP server periodically, it is necessary to configure the settings of the FTP server in advance.	56
	Schedule	Configure the settings relating to schedules of alarm permission, VMD permission and access permission.	57
Maintenance	System log	Displays the system log.	21
	Upgrade	Upgrade the firmware. The current firmware of this unit can be checked and upgraded to the latest version.	22
	Default reset	Configure the settings of this unit, initialize and the HTML data or reboot the unit.	23

[Basic] page

[Basic] tab

Refer to page 28 for general information about this tab.

Setup items		Setting values (<u>Underlined: default</u>)
Unit title		(Default: WJ-GXE500)
Camera title	Ch1	(Default: WJ-GXE500 Ch1)
	Ch2	(Default: WJ-GXE500 Ch2)
	Ch3	(Default: WJ-GXE500 Ch3)
	Ch4	(Default: WJ-GXE500 Ch4)
Time & date	Date/time *1	2010/01/01 00:00:00 - 2035/12/31 23:59:59
	Time display format	<u>24 h</u> /12 h/Off
	Date/time display format *2	DD/MM/YYYY (Default for the PAL model) MM/DD/YYYY DD/Mmm/YYYY YYYY/MM/DD Mmm/DD/YYYY (Default for the NTSC model)
	Summer time (daylight saving)	In/ <u>Out</u>
Camera title on screen		On/ <u>Off</u>
Camera title on screen (0-9, A-Z)	Ch1 - Ch4	(Default: None (blank))
OSD position	OSD Position	<u>Upper left</u> /Lower left/Upper right/Lower right
	Display style	Opaque/ <u>Transparent</u>
SD memory card error LED *3		<u>On</u> /Off
Alarm status update mode *4 *5		Polling(30sec)/ <u>Real time</u>
Alarm status reception port *6		1 - 65 535 (Default: 31 004)
Automatic installation of viewer software *7 *8		<u>On</u> /Off

Important:

- *7 • It is impossible to display images and to receive/transmit audio between the unit and the PC when the viewer software "Network Camera View 4" is not installed on the PC.
- *8 • The number of the viewer software installations can be checked on the [Upgrade] tab of the "Maintenance" page.

- *1 • The default time & date is calculated based on the manufacture date & time.
- *2 • When "10.04.01 13:10:00" is set for "Date/time" after selecting "24h" for "Date/time display format", time & date will be respectively displayed as follows.
DD/MM/YYYY: 01/04/2010 13:10:00
MM/DD/YYYY: 04/01/2010 13:10:00
DD/Mmm/YYYY: 01/Apr/2010 13:10:00
YYYY/MM/DD: 2010/04/01 13:10:00
Mmm/DD/YYYY: Apr/01/2010 13:10:00

- *3 • When "On" is selected, the SD memory card error LED will light when data cannot be saved on the SD memory card.
- *4 • Select the interval to refresh the alarm occurrence indication button, the [AUX] buttons and the SD recording status indicator on the "Live" page.
- *5 • Depending on the network environment, notification may not be provided in real time.
- *6 • The following port numbers are unavailable since they are already in use.
20, 21, 23, 25, 42, 53, 67, 68, 69, 80, 110, 123, 161, 162, 995, 10669, 10670

[SD memory card] tab

Refer to page 28 for general information about this tab. Refer to page 12 for how to operate.

Setup items		Setting values (Underlined: default)
SD memory card *1 *2	SD memory card	<u>Use</u> /Not use
	Remaining capacity notification *3	50%/20%/10%/5%/2%
	Save trigger *4	FTP error/Alarm input/Manual
		<u>Ch1/Ch2/Ch3/Ch4</u>
	Overwrite *5	On/ <u>Off</u>
	File name *6	(Default: None (blank))
	Image saving interval/ Number of images to be saved *7	Image saving interval
Number of images to be saved		10pics/20pics/30pics/50pics/ <u>100pics</u> / 200pics/300pics/500pics/1000pics/ 2000pics/3000pics
Image capture size *8	QVGA/ <u>VGA</u>	
SD memory card information	Remaining capacity *9	
	Format *10	
SD memory card images	Access img. *11 *12	

Important:

- *1 • When the image refresh interval is short, notification/recording timing or interval may become incorrect.
- Select "Not use" when operating without an SD memory card.
- Before removing the SD memory card from the unit, it is necessary to select "Not use" first.
- After inserting the SD memory card, it is necessary to select "Use" to use the SD memory card.
- When playing or downloading images saved on the SD memory card, it is necessary to select "On" for "Save logs" on the [Log] tab (☞ page 33) in advance.
- There are limited times to overwrite on an SD memory card. When having a high frequency of overwriting, the lifetime of the SD memory card may become shorter.
- When the setting is changed between "Use" and "Not use" while another user is during operation, the operation will be canceled.
- The data writing speed will go down after data are repeatedly written down on an SD memory card.

-
- *10
 - Use the SD memory card after formatting it using the [SD memory card] tab.
 - Before formatting the SD memory card, it is necessary to select "Use" for "SD memory card" and "Off" for "FTP periodic image transmission" on the [FTP img. trans.] tab of the "Network" page (☞ page 54).
 - It is impossible to access the SD memory card during the process of formatting.
 - When an SD memory card is formatted while another user is during operation, the operation will be canceled.
 - All data saved on the SD memory card will be deleted when the SD memory card is formatted.
 - Do not turn off the power of the unit during the process of formatting.
 - After formatting the SD memory card, available size may be smaller than the total size since the default directory is automatically created in the SD memory card.
 - Recommended SDHC/SD memory card
 Manufactured by Panasonic (option)
 SDHC memory card: 4 GB, 8 GB, 16 GB, 32 GB
 SD memory card: 256 MB, 512 MB, 1 GB, 2 GB
 (miniSD card and micro SD card excluded)
 - *11
 - It may sometimes be impossible to operate when another user is accessing images on the SD memory card. In this case, retry later.
 - Depending on the settings of a proxy server or a firewall, images may not be obtained via a network.
-
- *2
 - Notification/recording may also not be performed correctly as configured when multiple users are receiving images.
 - When "D1" is selected for "Image capture mode", it is impossible to save images on the SD memory card.
 - *3
 - When the mail notification function or the Panasonic alarm protocol function is used to provide notification of the remaining space of the SD memory card, select a level to be notified at from the following.
 - *4
 - Select "FTP error" when using the FTP periodic transmission function and when images are to be transmitted to the FTP server at an alarm occurrence.
 - When selecting "Alarm input", select the channel to save the images on the SD memory card.
 - *5
 - The overwrite setting will be as follows according to the "Save trigger" setting.
 FTP error: Will not be overwritten.
 Alarm input: Will be overwritten.
 Manual: Can be determined by selecting "On" or "Off" for "Overwrite".
 - *6
 - Enter the file name used for the image to be saved on the SD memory card. The file name will be as follows.
 File name: ["Entered file name" + "Time and date (year/month/day/hour/minute/second)"] + "Serial number" (☞ Page 56)
 - When "FTP error" is selected for "Save trigger", images will be saved with the file name entered on the [FTP img. trans.] tab of the "Network" page. (☞ Page 56)
 - *7
 - When selecting "Alarm input" for "Save trigger", select the image saving interval and the number of images to be saved. When selecting "Manual", select the image saving interval.
 - *8
 - When selecting "Manual" for "Save trigger", select the image capture size to save the images.
 - When "FTP error" is selected for "Save trigger", images will be saved with the image capture size selected on the [FTP img. trans.] tab of the "Network" page. (☞ Page 56)
 - When "Alarm input" is selected for "Save trigger", images will be saved with the image capture size selected on the [Alarm] tab of the "Alarm" page. (☞ Page 45)
 - *9
 - Total capacity and remaining space of the SD memory card will be displayed.
 - Depending on the status of the SD memory card, the size indications will differ as follows.
 -----KB/-----KB: No SD memory card is inserted. Failed to obtain available capacity due to error, etc.
 *****KB/*****KB: The SD card memory is unformatted, or locked, etc.

- *12
- It is necessary in advance to select "Allow" for "FTP access to unit" on the [Network] tab of the "Network" page. (☞ Page 54)
 - When logging in the unit to access images, drive B will be displayed first. Images are saved in different directories according to "Save trigger". Move to the directory corresponding to the desired images and copy them. Refer to page 72 for further information about the directory structure.

[Log] tab

Refer to page 28 for general information about this tab. Refer to page 17 for how to operate.

Setup items		Setting values (<u>Underlined: default</u>)
Alarm	Save logs	<u>On</u> /Off
	Name of the destination directory for downloaded images	(Default setting: C:\nwcam)
Manual	Save logs	<u>On</u> /Off
	Name of the destination directory for downloaded images	(Default setting: C:\nwcam)
FTP error	Save logs *1	<u>On</u> /Off
	Name of the destination directory for downloaded images	(Default setting: C:\nwcam)

Important:

- *1
- When "Name w/o time&date" is selected for "File name" on the [FTP img. trans.] tab on the "Network" page, FTP error log and associated will not be saved. (☞ Page 56)

[Image/Audio] page

[JPEG/H.264] tab

Refer to page 28 for general information about this tab.

Setup items		Setting values (Underlined: default)
Image capture mode *1 *2		<u>VGA</u> /D1
Ch selection *1		Ch1 only/Ch1-2/Ch1-3/ <u>Ch1-4</u>
JPEG	Ch1 - Ch4	Refresh interval (JPEG) * *3
		Image capture size
	Image quality	
Video encoding format		<u>H.264</u> /MPEG-4
H.264(1)	H.264 transmission *4 *5 *6	
	Internet mode (over HTTP) *7 *8 *9 *10 *11	
	Image capture size	
	Transmission priority *12	
	Frame rate *13 *14	
	Max bit rate (per client) * *15 *16 *17	
	Image quality *18	
	Refresh interval *19	
	Transmission type *20	
	Ch1	Unicast port1(Image) *21
Unicast port2(Audio) *21		
Multicast address		
Multicast port *21 *22		

Setup items			Setting values (Underlined: default)
H.264(1)	Ch2 - Ch4	Unicast port1(Image) *21	1 024 - 50 000 (Default: [Ch2] 32006 [Ch3] 32008 [Ch4] 32010)
		Multicast address	Available IPv4 address: 224.0.0.0 - 239.255.255.255 Available IPv6 address: Multicast address starting with "FF" (Default: [Ch2] 239.192.0.22 [Ch3] 239.192.0.24 [Ch4] 239.192.0.26)
		Multicast port *21	1 024 - 50 000 (Default: [Ch2] 37006 [Ch3] 37008 [Ch4] 37010)
	Multicast TTL/HOPLimit *23 *24		1 - 254 (Default: 16)
H.264(2)	H.264 transmission *4 *5 *6		<u>On/Off</u>
	Internet mode (over HTTP) *7 *8 *9 *10 *11		<u>On/Off</u>
	Image capture size *25		<u>QVGA/VGA</u>
	Transmission priority *12 *25		<u>Constant bit rate/Frame rate</u>
	Frame rate *13 *14 *25		NTSC model: 1fps/3fps/5fps */7.5fps */10fps */15fps */20fps */ <u>30fps *</u> PAL model: 1fps/3.1fps/4.2fps */6.25fps */8.3fps */12.5fps */ <u>20fps */25fps *</u>
	Max bit rate (per client) * *15 *16 *17 *25		64kbps/128kbps */256kbps */384kbps */512kbps */ 768kbps */1024kbps */1536kbps */2048kbps */ 3072kbps */4096kbps */Unlimited *
	Image quality *18 *25		Low(Motion priority)/ <u>Normal</u> /Fine(Image quality priority)
	Refresh interval *19 *25		0.2s/0.33s/0.5s/1s/2s/ <u>3s</u> /4s/5s
	Transmission type *20		<u>Unicast port (AUTO)</u> /Unicast port (MANUAL)/Multicast
	Ch1	Unicast port1(Image) *21	
Unicast port2(Audio) *21		1 024 - 50 000 (Default: 33 014)	
Multicast address		Available IPv4 address: 224.0.0.0 - 239.255.255.255 Available IPv6 address: Multicast address starting with "FF" (Default: 239.192.0.21)	
Multicast port *21 *22		1 024 - 50 000 (Default: 37 004)	

Setup items			Setting values (Underlined: default)
H.264(2)	Ch2 - Ch4	Unicast port1(Image) *21	1 024 - 50 000 (Default: [Ch2] 32016 [Ch3] 32018 [Ch4] 32020)
		Multicast address	Available IPv4 address: 224.0.0.0 - 239.255.255.255 Available IPv6 address: Multicast address starting with "FF" (Default: [Ch2] 239.192.0.23 [Ch3] 239.192.0.25 [Ch4] 239.192.0.27)
		Multicast port *21	1 024 - 50 000 (Default: [Ch2] 37006 [Ch3] 37008 [Ch4] 37010)
	Multicast TTL/HOPLimit *23 *24	1 - 254 (Default: 16)	

Important:

- *23 • When two or more network interface cards are installed on the PC in use, the network interface card(s) not used for receiving images should be invalidated when displaying images using the multicast port.
- *24 • When transmitting an H.264 image via a network, the transmitted image sometimes may not be displayed depending on the settings of a proxy server or a firewall. In this case, refer to the network administrator.

- *1 • When this setting is changed, the unit will reboot automatically.
- *2 • i-PRO Series does not support "D1", if not specified. (As of May, 2010)
- *3 • When "On" is selected for "H.264 transmission", the refresh interval may be longer than the set value when any value with an asterisk (*) on the right is selected.
- *4 • When "On" is selected for "H.264 transmission" in "H.264(1)" or "H.264(2)", the transmission interval of JPEG images may be longer.
- *5 • When "On" is selected for "H.264 transmission" in "H.264(1)", displaying of H.264 images or JPEG images on the "Live" page will be available.
- *6 • When "On" is selected for "H.264 transmission" in "H.264(1)" and "H.264(2)", H.264 images are viewable using other devices with each setting.
- *7 • When "On" is selected, H.264 images and audio will be transmitted using the HTTP port.
- *8 • When "On" is selected, only "Unicast port (AUTO)" will be available for "Transmission type".
- *9 • When "On" is selected, H.264 images may not be displayed depending on the number of the concurrent access users and audio data availability, etc.
- *10 • When "On" is selected, only IPv4 access is available.
- *11 • When "On" is selected for either "H.264(1)" or "H.264(2)", the maximum concurrent access number is equal to or less than 8 users.
- *12 • When "Frame rate" is set for "Transmission priority", number of users who can access the unit may be decreased.
- *13 • When "Frame rate" is selected for "Transmission priority", this setting is available.
- *14 • "Frame rate" is synchronized with "Max bit rate (per client) *". For this reason, the frame rate may be lower than the specified value when any value marked with an asterisk (*) is selected.
- *15 • "Unlimited *" is available when "Frame rate" is selected for "Transmission priority".
- *16 • The bit rate is synchronized with "Bandwidth control(bit rate)" on the [Network] tab of "Network" page. For this reason, the bit rate may be lower than the value when any value with an asterisk (*) on the right is selected. (Page 54)
- *17 • When "Unlimited *" is selected for either "H.264(1)" or "H.264(2)", the maximum concurrent access number is 1 user.
- *18 • When "Constant bit rate" is selected for "Transmission priority", this setting is available.

- *19 • Depending on the setting or photographic subject, images may not be refreshed at the exact designated interval.
- *20 • When "Multicast" is selected, set the value of "Bandwidth control(bit rate)" on the [Network] tab of "Network" page greater than the total value of "Max bit rate (per client) *" of all the channels in use. (Page 54)
- *21 • The following port numbers are unavailable since they are already in use.
10 669, 10 670
- *22 • When audio is transmitted from the unit, the port number to be used will be the multicast port number plus "1 000".
- *25 • When "On" is selected for "H.264 transmission" of "H.264(1)", the setting values selected for "H.264(1)" will be applied.

[JPEG/MPEG-4] tab

Refer to page 28 for general information about this tab.

Setup items		Setting values (Underlined: default)
Image capture mode *1 *2		<u>VGA/D1</u>
Ch selection *1		Ch1 only/Ch1-2/Ch1-3/ <u>Ch1-4</u>
JPEG	Ch1 - Ch4	Refresh interval (JPEG)* *3 NTSC model: 0.1fps/0.2fps/0.33fps/0.5fps/1fps/2fps/3fps */5fps */ 6fps */10fps */15fps */30fps * PAL model: 0.08fps/0.17fps/0.28fps/0.42fps/1fps/2.1fps/3.1fps */ 4.2fps */5fps */8.3fps */12.5fps */25fps *
	Image capture size	<u>QVGA/VGA</u>
	Image quality	0 Super fine/1 Fine/2/3/4/5 <u>Normal</u> /6/7/8/9 Low
Video encoding format		H.264/ <u>MPEG-4</u>
MPEG-4 (1)	MPEG-4 transmission *4 *5 *6	<u>On/Off</u>
	Internet mode (over HTTP) *7 *8 *9 *10 *11	<u>On/Off</u>
	Image capture size	<u>QVGA/VGA</u>
	Transmission priority *12	<u>Constant bit rate</u> /Frame rate
	Frame rate *13 *14	NTSC model: 1fps/3fps/5fps */7.5fps */10fps */15fps */20fps */ 30fps * PAL model: 1fps/3.1fps/4.2fps */6.25fps */8.3fps */12.5fps */ 20fps */25fps *
	Max bit rate (per client) * *15 *16 *17	64kbps/128kbps */256kbps */384kbps */512kbps */ 768kbps */1024kbps */1536kbps */ <u>2048kbps */</u> 3072kbps */4096kbps */Unlimited *
	Image quality *18	Low(Motion priority) / <u>Normal</u> / Fine(Image quality pri- ority)
	Refresh interval *19	0.2s/0.33s/0.5s/1s/2s/ <u>3s</u> /4s/5s
Transmission type *20	<u>Unicast port (AUTO)</u> /Unicast port (MANUAL)/Multicast	

Setup items		Setting values (Underlined: default)		
MPEG-4 (1)	Ch1	Unicast port1(Image) *21	1 024 - 50 000 (Default: 32 004)	
		Unicast port2(Audio) *21	1 024 - 50 000 (Default: 33 004)	
		Multicast address	Available IPv4 address: 224.0.0.0 - 239.255.255.255 Available IPv6 address: Multicast address starting with "FF" (Default: 239.192.0.20)	
		Multicast port *21 *22	1 024 - 50 000 (Default: 37 004)	
	Ch2 - Ch4	Unicast port1(Image) *21	1 024 - 50 000 (Default: [Ch2] 32006 [Ch3] 32008 [Ch4] 32010)	
		Multicast address	Available IPv4 address: 224.0.0.0 - 239.255.255.255 Available IPv6 address: Multicast address starting with "FF" (Default: [Ch2] 239.192.0.22 [Ch3] 239.192.0.24 [Ch4] 239.192.0.26)	
		Multicast port *21	1 024 - 50 000 (Default: [Ch2] 37006 [Ch3] 37008 [Ch4] 37010)	
	Multicast TTL/HOPLimit *23 *24		1 - 254 (Default: 16)	
	MPEG-4 (2)	MPEG-4 transmission *4 *5 *6		<u>On/Off</u>
		Internet mode (over HTTP) *7 *8 *9 *10 *11		<u>On/Off</u>
Image capture size *25		<u>QVGA/VGA</u>		
Transmission priority *12 *25		<u>Constant bit rate/Frame rate</u>		
Frame rate *13 *14 *25		NTSC model: 1fps/3fps/5fps */7.5fps */10fps */15fps */20fps */ <u>30fps *</u> PAL model: 1fps/3.1fps/4.2fps */6.25fps */8.3fps */12.5fps */ <u>20fps */25fps *</u>		
Max bit rate (per client) * *15 *16 *17		64kbps/128kbps */256kbps */384kbps */512kbps */ 768kbps */1024kbps */1536kbps */ <u>2048kbps */</u> 3072kbps */4096kbps */Unlimited *		
Image quality *18 *25		Low(Motion priority) / <u>Normal</u> / Fine(Image quality priority)		
Refresh interval *19 *25		0.2s/0.33s/0.5s/1s/2s/ <u>3s</u> /4s/5s		
Transmission type *20		<u>Unicast port (AUTO)</u> /Unicast port (MANUAL)/Multicast		

Setup items		Setting values (Underlined: default)	
MPEG-4 (2)	Ch1	Unicast port1(Image) *21	1 024 - 50 000 (Default: 32 014)
		Unicast port2(Audio) *21	1 024 - 50 000 (Default: 33 014)
		Multicast address	Available IPv4 address: 224.0.0.0 - 239.255.255.255 Available IPv6 address: Multicast address starting with "FF" (Default: 239.192.0.21)
		Multicast port *21 *22	1 024 - 50 000 (Default: 37 004)
	Ch2 - Ch4	Unicast port1(Image) *21	1 024 - 50 000 (Default: [Ch2] 32016 [Ch3] 32018 [Ch4] 32020)
		Multicast address	Available IPv4 address: 224.0.0.0 - 239.255.255.255 Available IPv6 address: Multicast address starting with "FF" (Default: [Ch2] 239.192.0.23 [Ch3] 239.192.0.25 [Ch4] 239.192.0.27)
		Multicast port *21	1 024 - 50 000 (Default: [Ch2] 37006 [Ch3] 37008 [Ch4] 37010)
Multicast TTL/HOPLimit *23 *24		1 - 254 (Default: 16)	

Important:

- *23 • When two or more network interface cards are installed on the PC in use, the network interface card(s) not used for receiving images should be invalidated when displaying images using the multicast port.
- *24 • When transmitting an MPEG-4 image via a network, the transmitted image sometimes may not be displayed depending on the settings of a proxy server or a firewall. In this case, refer to the network administrator.

- *1 • When this setting is changed, the unit will reboot automatically.
- *2 • i-PRO Series does not support "D1", if not specified. (As of May, 2010)
- *3 • When "On" is selected for "MPEG-4 transmission", the refresh interval may be longer than the set value when any value with an asterisk (*) on the right is selected.
- *4 • When "On" is selected for "MPEG-4 transmission" in "MPEG-4(1)" or "MPEG-4(2)", the transmission interval of JPEG images may be longer.
- *5 • When "On" is selected for "MPEG-4 transmission" in "MPEG-4(1)", displaying of MPEG-4 images or JPEG images on the "Live" page will be available.
- *6 • When "On" is selected for "MPEG-4 transmission" in "MPEG-4(1)" and "MPEG-4(2)", MPEG-4 images are viewable using other devices with each setting.
- *7 • When "On" is selected, MPEG-4 images and audio will be transmitted using the HTTP port.
- *8 • When "On" is selected, only "Unicast port (AUTO)" will be available for "Transmission type".
- *9 • When "On" is selected, MPEG-4 images may not be displayed depending on the number of the concurrent access users and audio data availability, etc.
- *10 • When "On" is selected, only IPv4 access is available.
- *11 • When "On" is selected for either "MPEG-4(1)" or "MPEG-4(2)", the maximum concurrent access number is equal to or less than 8 users.

- *12 • When "Frame rate" is set for "Transmission priority", number of users who can access the unit may be decreased.
- *13 • When "Frame rate" is selected for "Transmission priority", this setting is available.
- *14 • "Frame rate" is synchronized with "Max bit rate (per client) *". For this reason, the frame rate may be lower than the specified value when any value marked with an asterisk (*) is selected.
- *15 • "Unlimited *" is available when "Frame rate" is selected for "Transmission priority".
- *16 • The bit rate is synchronized with "Bandwidth control(bit rate)" on the [Network] tab of "Network" page. For this reason, the bit rate may be lower than the value when any value with an asterisk (*) on the right is selected.
- *17 • When "Unlimited *" is selected for either "MPEG-4(1)" or "MPEG-4(2)", the maximum concurrent access number is 1 user.
- *18 • When "Constant bit rate" is selected for "Transmission priority", this setting is available.
- *19 • Depending on the setting or photographic subject, images may not be refreshed at the exact designated interval.
- *20 • When "Multicast" is selected, set the value of "Bandwidth control(bit rate)" on the [Network] tab of "Network" page greater than the total value of "Max bit rate (per client) *" of all the channels in use.
- *21 • The following port numbers are unavailable since they are already in use.
10 669, 10 670
- *22 • When audio is transmitted from the unit, the port number to be used will be the multicast port number plus "1 000".
- *25 • When "On" is selected for "MPEG-4 transmission" of "MPEG-4(1)", the setting values selected for "MPEG-4(1)" will be applied.

[Image/Position] tab

Refer to page 28 for general information about this tab.

Setup items	Setting values (Underlined: default):
Ch No.	<u>1/2/3/4</u>
Menu	On/Off
Operation buttons	Set Up Down Left Right Esc Reset/Special All Reset
Zoom	Zoom out/x1/Zoom in
Focus	Auto/Near/Far
Control pad	

About the operation panel

Use the following buttons on the operation panel to operate the "Camera setup" page using a PC.



On : Click this button to display the setup menu of camera.

Off : Click this button to close the setup menu of camera.

Set : Click this button to move to the submenu.

▲ / **▼** : Click these buttons to move the cursor.

◀ / **▶** : Click these buttons to select the parameters.

Esc : Click this button to return to the previous page.

Reset/Special : Display the setup menu of camera, move the cursor onto "SPECIAL", and click this button to move to the SPECIAL SETUP menu.

Move the cursor onto REFRESH on the SPECIAL SETUP menu, and click this button to refresh the camera position.

Item names and operations may differ depending on the cameras. Refer to the operating instructions of the camera for further information.

All Reset : Click this button after moving the cursor onto CAMERA RESET on the SPECIAL SETUP menu to reset to the default setting. Refer to the operating instructions of each camera for further information about the settings to be reset.

[Audio] tab

Refer to page 28 for general information about this tab.

Setup items	Setting values (Underlined: default)
Audio transmission/reception *1 *2 *3 *4	Off/Mic input/Audio output/Interactive(Half-duplex)/ Interactive(Full-duplex)
Audio bit rate *5	16kbps/ <u>32kbps</u>
Mic input volume (Camera to PC)	Mic High/ <u>Mic Middle</u> /Mic Low/Line High/Line Middle/Line Low
Mic Input Interval (Camera to PC) *6 *7	20ms/ <u>40ms</u> /80ms/160ms
Audio output volume (PC to Camera)	High/ <u>Middle</u> /Low
Audio output interval (PC to Camera) *6 *7 *8 *9	160ms/320ms/ <u>640ms</u> /1280ms
Audio output port (PC to Camera) *10	1 024 - 50 000 (Default: 34 004)
Permission level of audio trans./recep.	1. Level 1 only/2. Level 2 or higher/3. All users

*1 • Images and audio will not be synchronized. Therefore, images and audio may not always match.

*2 • Audio may be interrupted depending on the network environment.

*3 • Howling may be generated depending on usage conditions. If howling is generated, prevent sound generated by the PC from entering the PC microphone.

- *4 • When "Multicast" is selected for "Transmission type" on the [JPEG/H.264] (or [JPEG/MPEG-4]) tab of the "Image/Audio" page, audio transmission will become unavailable while monitoring H.264 (or MPEG-4) images. To transmit audio, click the [JPEG] button on the "Live" page.
- *5 • When selecting a smaller value for "Bandwidth control(bit rate)" on the [Network] tab of the "Network" page (☞ page 54) while putting a priority on the JPEG/MPEG-4 image transmission, select "16kbps" for "Audio bit rate".
- *6 • When a shorter interval is selected, delay time will be shorter.
- *7 • Making the value bigger will result in a longer delay, but audio interruptions can be minimized.
- *8 • Audio may temporarily be interrupted or noise may be heard the unit, or when multiple users are accessing concurrently. It may be possible to diminish the interruption or noise by setting a longer interval for "Audio output interval (PC to Camera)".
- *9 • Audio may sometimes not be heard depending on the network environment.
- *10 • The transmission port number entered for "Audio output port (PC to Camera)" will be used only when "Unicast port (MANUAL)" is selected for "Transmission type".
When "Off" is selected for "H.264 transmission" (or "MPEG-4 transmission") (☞ pages 34 and 37) or when "Unicast (AUTO)" or "Multicast" is selected for "Transmission type", it is not necessary to enter the transmission port number.

[Coaxial/RS-485] tab

Refer to page 28 for general information about this tab.

Setup items		Setting values (Underlined: default)	
Coaxial	Video sync *1 *2	Ch1/ <u>Int</u>	
	Ch1 - Ch4	VD2 *3	On/ <u>Off</u>
		Data *4	<u>On</u> /Off
		Cable compensation *5 *6 *7	<u>S</u> /M/L
RS-485	Communication protocol *8 *9 *10	4-line/2-line	
	Baud rate	2400bps/4800bps/9600bps/ <u>19200bps</u> /38400bps	
	Data bit	7bit/ <u>8bit</u>	
	Parity check	<u>None</u> /Odd/Even	
	Ch1 - Ch4	Data *11	On/ <u>Off</u>
		Unit address *12	(Default: [Ch1] 01 [Ch2] 02 [Ch3] 03 [Ch4] 04)

Important:

- *1 • When "Ch1" is selected for "Video sync", the unit is synchronized with the video signal that is input to Ch1. Synchronize other video signals that are input to other channels with Ch1.
- *2 • When "Ch1" is selected for "Video sync", the unit is synchronized with the phase of the video signal that is input to Ch1. Synchronize the phases of other video signals that are input to other channels with Ch1.
- *5 • Perform the settings for the cable compensation properly according to the cable length. Otherwise camera pictures may not be displayed/recorded correctly.

-
- *3 • Select "On" or "Off" to determine whether or not to apply the VD2 synchronization method for the connected camera. When a camera not supporting the VD2 synchronization method is connected, select "Off" for "VD2".
 - *4 • Select "On" to control cameras with the coaxial communication.
 - *6 • It is possible to compensate for the video signal transmission loss from the camera.
 - *7 • The following cable length settings are references when using RG-59/U, BELDEN 9259 (for NTSC models), 5C-2V (for PAL models) or equivalent cables.
 - S: Less than 400 m {1 300 ft.}
 - M: 400 m {1 300 ft.} to 700 m {2 300 ft.}
 - L: 700 m {2 300 ft.} to 1 200 m {4 000 ft.}
 - *8 • When cameras with the different RS-485 protocols (for example, cameras manufactured by Panasonic and those manufactured by Pelco, Inc.) in the same RS-485 communication line, the cameras will not work correctly.
 - *9 • Select the communication protocol that is compliant with the specifications of the connected cameras.
 - *10 • Refer to the readme file on the provided CD-ROM for further information about the RS-485 command table.
 - *11 • Select "On" to control cameras with the RS-485 communication.
 - *12 • Set the value in accordance with the RS-485 command table. Refer to the readme file on the provided CD-ROM for further details.

[Multi-screen] page

[Multi-screen setup] tab

Refer to page 28 for general information about this tab. Refer to page 12 for how to operate.

Setup items		Setting values (Underlined: default)	
Group A	Cam. 1 - Cam. 4	IP address *1 *2	(Default: None (blank))
		Ch No. *3	<u>-</u> /Ch1/Ch2/Ch3/Ch4
		Camera title *4	(Default: None (blank))
Group B	Cam. 5 - Cam. 8	IP address *1 *2	(Default: None (blank))
		Ch No. *3	<u>-</u> /Ch1/Ch2/Ch3/Ch4
		Camera title *4	(Default: None (blank))
Group C	Cam. 9 - Cam. 12	IP address *1 *2	(Default: None (blank))
		Ch No. *3	<u>-</u> /Ch1/Ch2/Ch3/Ch4
		Camera title *4	(Default: None (blank))
Group D	Cam. 13 - Cam. 16	IP address *1 *2	(Default: None (blank))
		Ch No. *3	<u>-</u> /Ch1/Ch2/Ch3/Ch4
		Camera title *4	(Default: None (blank))

- *1 • When using the host name, it is necessary to configure the DNS settings of the PC to be used for the multi-screen display. (☞ Page 54)
- *2 • Regardless of the settings of the registered device, the images will be displayed altered to the aspect ratio of 4:3 on a multi-screen.
- *3 • Select "-" when displaying images on a multi-screen using a device without channel information.
- *4 • When selecting a 16 split-screen, some characters of the camera title to be displayed may not be displayed.

[Alarm] page

[Alarm] tab

Refer to page 28 for general information about this tab. Refer to page 13 for further information about the actions.

Setup items		Setting values (Underlined: default)	
Alarm	Terminal 1 *1 *2	<u>Ch1/Ch2/Ch3/Ch4</u>	
		<u>Off/Alarm input</u>	
	Terminal 2 *1 *2	<u>Ch1/Ch2/Ch3/Ch4</u>	
		<u>Off/Alarm input/Alarm output</u>	
	Terminal 3 *1 *2	<u>Ch1/Ch2/Ch3/Ch4</u>	
		<u>Off/Alarm input/Alarm output/AUX output</u>	
	VMD alarm		
	Command alarm	Command alarm *1	<u>Ch1/Ch2/Ch3/Ch4</u>
		Originating port number *3	1 - 65 535 (Default: 8 181)
	Camera site alarm	Ch1 - Ch4	On/ <u>Off</u>
Video loss	Ch1 - Ch4	On/ <u>Off</u>	
Alarm image	Alarm image FTP transmission *4 *5 *6		On/ <u>Off</u>
	Directory name		(Default: None (blank))
	File name		(Default: None (blank))
	Post alarm	Transmission interval *7	NTSC Model: 0.1fps/0.2fps/0.33fps/0.5fps/ <u>1fps</u> PAL Model: 0.08fps/0.17fps/0.28fps/0.42fps/ <u>1fps</u>
		Number of images	1pic/2pics/3pics/4pics/5pics/6pics/7pics/ 8pics/9pics/10pics/20pics/30pics/50pics/ 100pics/200pics/300pics/500pics/ 1000pics/2000pics/3000pics
		Recording duration *8	(Default: 100 sec.)
	Image capture size		<u>QVGA/VGA</u>
	Image compression rate upon alarm detection		On/ <u>Off</u>
	Image quality upon alarm detection		0 Super fine/1 Fine/2/3/4/5 <u>Normal</u> /6/7/8/ 9 Low
	Alarm output terminal setup	Alarm output trigger	
Alarm output type		<u>Latch/Pulse</u>	
Trigger output *9		Open/ <u>Close</u>	
Pulse width		1 - 120 sec. (Default: 1 sec.)	
AUX title	AUX (Up to 10 characters)		(Default: AUX)
	Open (Up to 5 characters)		(Default: Open)
	Close (Up to 5 characters)		(Default: Close)

Important:

- *4 • When "Alarm input" or "Manual" is selected for "Save trigger" on the [SD memory card] tab, images will not be transmitted to the FTP server even when an alarm is detected.
 - *7 • Depending on the network line speed or the network traffic, images may not be transmitted at the exact designated interval or period.
-

- *1 • "Alarm input", "Alarm output" and "Command alarm" are activated for the selected channel.
- *2 • Refer to the installation guide for further information about input/output rating of each terminal.
- *3 • The following port numbers are unavailable since they are already in use.
20, 21, 23, 25, 42, 53, 67, 68, 69, 80, 110, 123, 161, 162, 554, 995, 10 669, 10 670, 52 000, 59 000 - 61 000
- *5 • To transmit alarm images to an FTP server, it is necessary to configure the settings in advance. (☞ Page 52)
- *6 • When "D1" is selected for "Image capture mode", Alarm FTP image transmission is unavailable.
- *8 • The values (transmission interval x number of images) will automatically be set.
- *9 • When "Open" is selected, the alarm signal will be output for around 20 seconds when the power of the unit is turned on.

[VMD area] tab

Refer to page 28 for general information about this tab.

Setup items		Setting values (<u>Underlined: default</u>)	
Ch No.		<u>1/2/3/4</u>	
Area	1 (White) / 2 (Blue) / 3 (Green) / 4 (Red)	Status	<u>On/Off</u>
		Detection area	1 - 10 (Default: 1)
		Detection sensitivity	1 - 15 (Default: 8)
VMD information addition	Information addition *1 *2	<u>On/Off</u>	

Important:

- The alarm occurrence indication button (☞ page 13) will be displayed when motion is detected by the VMD function.
 - The alarm occurrence indication button will be displayed when receiving an alarm input of a terminal alarm or a command alarm.
 - Depending on the network environment, notification may be delayed even when "Real time" is selected for "Alarm status update mode" on the [Basic] tab of the "Basic" page (☞ page 30).
 - The motion detection function is not the dedicated function to prevent thefts, fires, etc. We are not responsible for any accidents or damages occurring in case.
 - When "Multicast" is selected for "Transmission type" on the [JPEG/H.264] (☞ page 34) (or [JPEG/MPEG-4] (☞ page 37)) tab or "On" is selected for "Priority stream" on the [System] tab, it may sometimes be impossible to display the VMD area setup window.
-

- *1 • The VMD information can be searched by Panasonic network disk recorders (WJ-ND400 series). Refer to the operating instructions of the connected devices for further information about the functions and settings.
- *2 • While a camera is during operation such as panning, tilting, zooming, focus adjustment, brightness adjustment or auto mode, the VMD information will be added.

The following is the procedure to set VMD areas

Important:

- When the settings are being configured on the setup menu, sometimes the VMD function may not work correctly.
-

Step 1

Set the video motion detection area by dragging the mouse on the screen.

- The designated area will become the VMD area and the outline will be displayed. When 2 - 4 VMD areas are set, each area will be numbered in order. The areas will be identified by the respective outline colors. The "Status" of the outline to be set for the area will become "Valid".

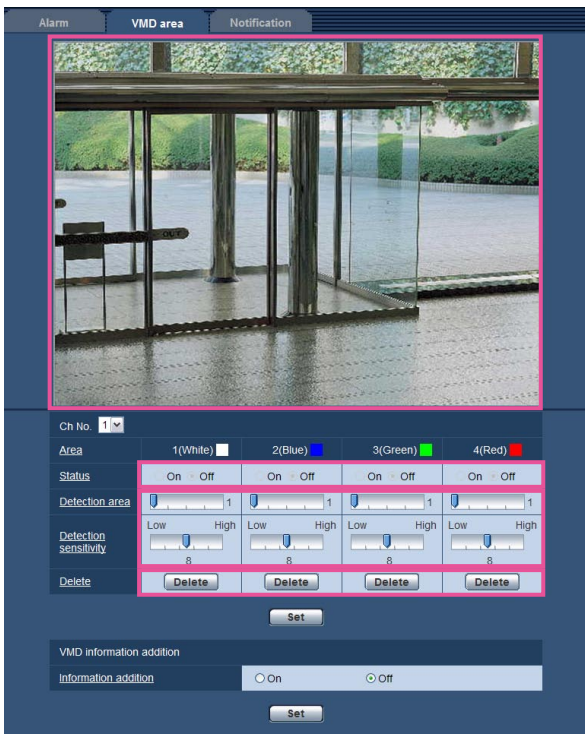

Step 2

Adjust "Detection area" and "Detection sensitivity" using the slide bar. The currently displayed area and its detection sensitivity will be displayed in the "Detection area" section. Change areas and the settings of "Detection area" and "Detection sensitivity" as necessary.

Step 3

Click the [Set] button after completing the settings.

Important:

- The setting will not be applied unless the [Set] button is clicked.
-

Step 4

To invalidate the VMD area, click the [Set] button after selecting "Off" for "Status" of the VMD area to be invalidated.

- The outline of the invalidated VMD area will turn to a dotted line. When the VMD area is invalidated, no alarm will occur even when a motion can be recognized in the area.

Step 5

To delete the VMD area, click the [Delete] button corresponding to the area to be deleted.

- The outline of the respective VMD area will disappear.

Step 6

Click the [Set] button.

- The edited settings will be applied.

[Notification] tab

Refer to page 28 for general information about this tab.

Setup items		Setting values (<u>Underlined</u> : default)	
Mail notification	Mail notification	On/ <u>Off</u>	
Destination of notification	Address1 - 4	Alarm *1	On/ <u>Off</u>
		Diag. *2	On/ <u>Off</u>
		Destination address	(Default: None (blank))
	Mail subject		(Default: None (blank))
	Mail body *3		(Default: None (blank))
Panasonic alarm protocol notification	Panasonic alarm protocol *4		On/ <u>Off</u>
	Destination port *5		1 - 65 535 (Default: 1 818)
	Retry times		0 - 30 (Default: 2)
Destination of notification *6	Address1 - 3	Alarm *7	On/ <u>Off</u>
		Diag. *8	On/ <u>Off</u>
		Destination IP address	(Default: None (blank))

Important:

*6 • When a device does not exist on the registered IP address, notification may be delayed.

- *1 • The mail notification will be performed upon an alarm occurrence.
- *2 • Mail notification will be provided in the following cases.
 - When it is configured to notify users of available capacity of the SD memory card
 - When the capacity of the SD memory card has become insufficient
 - When the SD memory card has failed to mount
 - When the video loss is recovered
- *3 • Notification mail will be sent with the following message. (The message to be sent differs depending on the status of the SD memory card.)
 - "The SD memory card is full." (This message will be sent when the SD memory card becomes full.)
 - "The SD memory card cannot be recognized." (This message will be sent when the SD memory card has failed to mount.)
- *4 • When "On" is selected, notification of the alarm occurrence will be provided to the registered destination addresses in order (to IP address 1 first, to IP address 3 last).
- *5 • The following port numbers are unavailable since they are already in use.
20, 21, 23, 25, 42, 53, 67, 68, 69, 80, 110, 123, 161, 162, 995, 10 669, 10 670
- *7 • The Panasonic alarm notification will be provided upon an alarm occurrence.
- *8 • Maintenance requirement will be notified in the following cases.
 - When it is configured to notify users of available capacity of the SD memory card
 - When the capacity of the SD memory card has become insufficient
 - When the SD memory card has failed to mount
 - When the video loss is recovered

[Advanced func.] page

[XML notification] tab

Refer to page 28 for general information about this tab.

Setup items		Setting values (Underlined: default)	
XML notification *1	XML notification *2	On/ <u>Off</u>	
	Notification interval	<u>1s</u> /2s	
Destination setting for XML notification	Destination1 - 2	Destination address	(Default: None (blank))
		Destination port number *3	1 - 65535 (Default: None (blank))
		Destination path name	(Default: None (blank))
		User name	(Default: None (blank))
		Password	(Default: None (blank))

- *1
- When "D1" is selected for "Image capture mode", it is impossible to activate the XML notification function.
- *2
- When "On" is selected, face detection information is notified to the designated destination server in the XML format.
- *3
- The following port numbers are unavailable since they are already in use.
20, 21, 23, 25, 42, 53, 67, 68, 69, 110, 123, 161, 162, 995, 10 669, 10 670

[Face detection] tab

Refer to page 28 for general information about this tab.

Setup items		Setting values (Underlined: default)
Face detection	Face detection *1 *2 *3 *4	On/ <u>Off</u>
	XML notification	

Important:

- When "Multicast" is selected for "Transmission type" on the [JPEG/H.264] (or [JPEG/MPEG-4]) tab and "On" is selected for "Priority stream" on the [System] tab, it may sometimes be impossible to display the face detection setup window.
- *1
- The face detection function shall not guarantee the detection of faces in an image. The face detection accuracy varies with imaging conditions.
- *2
- When "Mosaic" is selected for "Display type" of "Privacy zone", the face detection function may sometimes be triggered (the face detection frame will be displayed).
- *3
- When "D1" is selected for "Image capture mode", it is impossible to activate the face detection function.
- *4
- Face detection is available on Ch1 only.

[User mng.] page

[User auth.] tab

Refer to page 29 for general information about this tab.

Setup items	Setting values (Underlined: default)
User auth. *1	On/ <u>Off</u>
User name	(Default: None (blank))
Password *2	(Default: None (blank))
Retype password	(Default: None (blank))
Access level *3	1. Administrator/2. Camera control/ <u>3. Live only</u>
User check *4	(Example: admin [1])

- *1
 - When user authentication (authentication error) has failed to pass 8 times within 30 seconds using the same IP address (PC), access to the unit will be denied for a while.
- *2
 - When the user name already in use is entered and the [Register] button is clicked, the respective user information will be overwritten.
- *3
 - 1. Administrator: Allowed all available operations of the unit.
 - 2. Camera control: Allowed to display images from the camera and to control the camera. The unit setting configuration is unavailable.
 - 3. Live only: Only displaying live images is available. The unit setting configuration and camera control are unavailable.
- *4
 - The registered users will be displayed in the drop-down list as follows: "User name [access level]"

[Host auth.] tab

Refer to page 29 for general information about this tab.

Setup items	Setting values (Underlined: default)
Host auth.	On/ <u>Off</u>
IP address *1 *2	(Default: None (blank))
Access level	1. Administrator/2. Camera control/ <u>3. Live only</u>
Host check *3	

- *1
 - When "IP address/subnet mask" is entered, it is possible to restrict PCs in each subnet. For example, when "192.168.0.1/24" is entered and "2. Camera control" is selected for the access level, the PCs whose IP address is between "192.168.0.0" - "192.168.0.255" can access the unit with the access level "2. Camera control".
- *2
 - When the IP address already in use is entered and the [Set] button is clicked, the respective host information will be overwritten.
- *3
 - The registered hosts will be displayed in the drop-down list as follows: "Host name [access level]" (Example: 192.168.0.21 [1])

[System] tab

Refer to page 29 for general information about this tab.

Setup items		Setting values (Underlined: default)
Priority stream	Activation *1	On/Off
	Destination IP address(1) - (4)	(Default: None (blank))
	Stream type	<u>JPEG</u> H.264/MPEG-4(1) H.264/MPEG-4(2)
	Refresh interval* *2 *3	NTSC model: 0.1fps/0.2fps/0.33fps/0.5fps/ <u>1fps</u> /2fps/3fps */ 5fps */6fps */10fps */15fps */ 30fps * PAL model: 0.08fps/0.17fps/0.28fps/0.42fps/ <u>1fps</u> /2.1fps/ 3.1fps */4.2fps */ 5fps */8.3fps */12.5fps */ 25fps *
Image capture size *3	QVGA/ <u>VGA</u>	

- *1
 - When "On" is selected for "Activation" of "Priority stream", number of users who can access the unit may be limited.
- *2
 - When "On" is selected for "H.264 transmission" (or "MPEG-4 transmission") or "Ch1 only" is not selected for "Ch selection", the refresh interval may be longer than the set value when any value with an asterisk (*) on the right is selected.
- *3
 - This setting is validated only when "JPEG" is selected for "Stream type".

[Server] page

[Mail] tab

Refer to page 29 for general information about this tab.

Setup items	Setting values (Underlined: default)	
SMTP server address *1	(Default: None (blank))	
SMTP port *2	1 - 65535 (Default: 25)	
POP server address *1	(Default: None (blank))	
Authentication	Type *3	<u>None</u> /POP before SMTP/SMTP
	User name	(Default: None (blank))
	Password	(Default: None (blank))
Sender's mail address	(Default: None (blank))	

Important:

- When a terminal that receives e-mails is not compatible with UTF-8 encode, it is impossible to receive alarm mails correctly.

*1 • When entering the host name for "SMTP server address" or "POP server address", it is necessary to configure the DNS settings on the [Network] tab of the "Network" page. (☞ Page 54)

*2 • The following port numbers are unavailable since they are already in use.
20, 21, 23, 42, 53, 67, 68, 69, 80, 110, 123, 161, 162, 995, 10 669, 10 670

*3 • When you don't know the authentication method to send e-mails, refer to the network administrator.

[FTP] tab

Refer to page 29 for general information about this tab.

Setup items	Setting values (Underlined: default)
FTP server address *1	(Default: None (blank))
User name	(Default: None (blank))
Password	(Default: None (blank))
Control port *2	1 - 65535 (Default: 21)
FTP mode	<u>Passive</u> /Active

Important:

*1 • When entering the host name for "FTP server address", it is necessary to configure the DNS settings on the [Network] tab of the "Network" page. (☞ Page 54)

*2 • The following port numbers are unavailable since they are already in use.
20, 23, 25, 42, 53, 67, 68, 69, 80, 110, 123, 161, 162, 995, 10 669, 10 670

[NTP] tab

Refer to page 29 for general information about this tab.

Setup items	Setting values (<u>Underlined: default</u>)
Time adjustment *1	<u>Manual</u> /Synchronization with NTP server
NTP server address *2	(Default: None (blank))
NTP port *3	1 - 65535 (Default: 123)
Time adjustment interval	<u>1h</u> - 24h
Time zone	(Default: (GMT) Greenwich Mean Time : Dublin, Edinburgh, Lisbon, London)

Important:

- *2
 - Use an NTP server when the more accurate time & date setting is required for the system operation.
 - When entering the host name for "NTP server address", it is necessary to configure the DNS settings on the [Network] tab of the "Network" page. (☞ Page 54)
- *1
 - When "Manual" is selected, the time set on the [Basic] tab on the "Basic" page will be used as the standard time of the unit. (☞ Page 30)
- *3
 - The following port numbers are unavailable since they are already in use.
20, 21, 23, 25, 42, 53, 67, 68, 69, 80, 110, 161, 162, 995, 10 669, 10 670

[Network] page

[Network] tab

Refer to page 29 for general information about this tab.

Setup items		Setting values (Underlined: default)
IPv4 network	DHCP *1	On/ <u>Off</u>
	IP address(IPv4) *2	(Default: 192.168.0.10)
	Subnet mask	(Default: 255.255.255.0)
	Default gateway *3	(Default: 192.168.0.1)
IPv6 network	Manual	On/ <u>Off</u>
	IP address(IPv6) *4	(Default: None (blank))
Common	DNS *5 *6	Auto/ <u>Manual</u>
	Primary server address *7	(Default: None (blank))
	Secondary server address *7	(Default: None (blank))
	HTTP port *8	1 - 65 535 (Default: 80)
	Line speed *9	<u>Auto</u> /100M-Full/100M-Half/10M-Full/10M-Half
FTP access to unit	Allow/ <u>Forbid</u>	
Bandwidth control(bit rate) *10 *11 *12	<u>Unlimited</u> /64kbps/128kbps/256kbps/384kbps/512kbps/ 768kbps/1024kbps/2048kbps/4096kbps/8192kbps	
Easy IP Setup accommodate period	<u>20 min</u> /Unlimited	

- *1 • Configure the DHCP server not to assign the same IP addresses used for the other network devices and PCs whose IP address is unique. Refer to the network administrator for further information about the settings of the server.
- *2 • Do not enter an IP address already in use (for the PCs and the other network devices).
- *3 • Multiple IP addresses for the default gateway are unavailable even when using the DHCP function. Refer to the network administrator for further information about the settings of the DHCP server.
- *4 • To establish connections beyond the router via an IP address entered manually, use an IPv6 compatible router, and activate the auto configuration function of IP address. In addition, set an IPv6 address including prefix information given by the IPv6 compatible router.
- *5 • Multiple IP addresses for the default gateway are unavailable even when using the DHCP function. Refer to the network administrator for further information about the settings of the DHCP server.
- *6 • When using the DHCP function, it is possible to obtain the DNS address automatically by selecting "Auto". Refer to the network administrator for further information about the settings of the DHCP server.
- *7 • It is impossible to use both an IPv4 DNS server and an IPv6 DNS server.
- *8 • The following port numbers are unavailable since they are already in use.
20, 21, 23, 25, 42, 53, 67, 68, 69, 110, 123, 161, 162, 554, 995, 10 669, 10 670, 52 000, 59 000 - 61 000
- *9 • It is recommended to use with the default "Auto".
- *10 • When selecting "64kbps", select "Off" for "Audio mode" on the [Audio] tab. (Page 41)
- *11 • Select "128kbps" or a faster rate to carry out the live transmission of JPEG images and the FTP periodic image transmission simultaneously.

- *12 • When "Bandwidth control(bit rate)" on the [Network] tab of the "Network" page is set low, taking a picture using the one shot button may not function depending on the use environment. In this case, select "QVGA" for "Image capture size" of "JPEG" on the [JPEG/H.264] (page 34) (or [JPEG/MPEG-4] (page 37)) tab or set "Image quality" of "JPEG" lower.

Note:

- Refer to the network administrator for the addresses of each server.
- The port forwarding function changes a global IP address to a private IP address, and "Static IP masquerade" and "Network Address Translation (NAT)" have this function. This function is to be set in a router.
- To access this unit via the Internet by connecting the unit to a router, it is necessary to assign a respective HTTP port number for each device and address translation by using the port forwarding function of the router. Refer to the operating instructions of the decoder for further information.

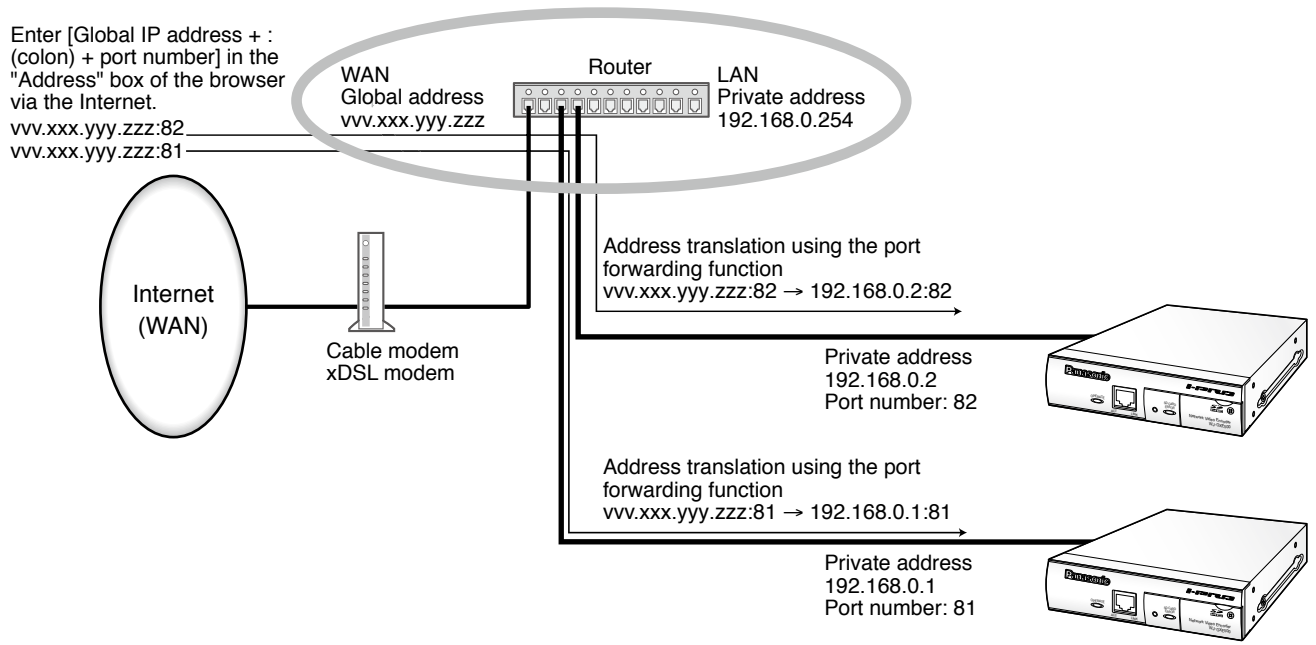

[DDNS] tab

Refer to page 29 for general information about this tab.

Setup items	Setting values (Underlined: default)
DDNS	On/Off
Host name	(Default: None (blank))
User name	(Default: None (blank))
Password	(Default: None (blank))
Access interval	1min/10min/30min/ <u>1h</u> /6h/24h

- When communicating using IPv4, obtain a global IP address from the DHCP server. To access this unit via the Internet, it is necessary to configure the settings for the DDNS function. When using the DDNS function, it is possible to access with "Host name registered in the DDNS server.nmdns.net". To use the DDNS function, it is necessary to connect to the dedicated DDNS server. Refer to the web site for further information about the DDNS. Refer to the readme file on the provided CD-ROM for the web site.

[SNMP] tab

Refer to page 29 for general information about this tab.

Setup items	Setting values (Underlined: default)
Community *1	(Default: <u>None (blank)</u>)
System name	(Default: <u>None (blank)</u>)
Location	(Default: <u>None (blank)</u>)
Contact	(Default: <u>None (blank)</u>)

Important:

- *1
- When using the SNMP function, it is necessary to enter the community name. When no community name is entered, the SNMP function will not work.

[FTP img. trans.] tab

Refer to page 29 for general information about this tab. Refer to page 15 for further information about the actions.

Setup items	Setting values (Underlined: default)		
FTP periodic image transmission	FTP periodic image transmission *1 *2		
	Directory name	(Default: <u>None (blank)</u>)	
	File name	(Default: <u>None (blank)</u>) <u>Name w/time&date</u> / Name w/o time&date	
	Transmission interval *3 *4 *5	<u>1s/2s/3s/4s/5s/6s/10s/15s/20s/30s/1min/2min/3min/4min/5min/6min/10min/15min/20min/30min/1h/1.5h/2h/3h/4h/6h/12h/24h</u>	
Image capture size	<u>QVGA/VGA</u>		
FTP image transmission schedule	Schedule 1 - 3	Mon/Tue/Wed/Thu/Fri/Sat/Sun	<u>On/Off</u>
		24h	<u>On/Off</u>
	Hour (start)	00 - 23 (hour) (Default: 00)	
	Minute (start)	00 - 59 (minute) (Default: 00)	
	Hour (stop)	00 - 23 (hour) (Default: 00)	
	Minute (stop)	00 - 59 (minute) (Default: 00)	

Important:

- *1
- When "Alarm input" or "Manual" is selected for "Save trigger" on the [SD memory card] tab, the FTP periodic image transmission function will become unavailable. (Page 31)
- *2
- When "D1" is selected for "Image capture mode", FTP periodic image transmission is unavailable.
- *3
- Depending on the network line speed or the network traffic, images may not be transmitted at the exact designated interval or period.
- *4
- When "On" is selected for both of the alarm image transmission function and the FTP periodic image transmission function, the alarm image transmission function will be given priority over the FTP periodic image transmission function. For this reason, images may not be transmitted at the exact designated interval or period if alarms occur frequently.

- *5
- Depending on the use environment, images may not be transmitted at the exact designated interval.

[Schedule] page

[Schedule] tab

Refer to page 29 for general information about this tab.

Setup items		Setting values (Underlined: default)	
Schedules	Schedule1 - 5	Schedule mode *1 *2 *3 *4	<u>Off</u> /Alarm permission/VMD permission/ Access permission
		Mon/Tue/Wed/Thu/Fri/Sat/Sun	On/ <u>Off</u>
		24h	On/ <u>Off</u>
		Hour (start)	00 - 23 (hour) (Default: 00)
		Minute (start)	00 - 59 (minute) (Default: 00)
		Hour (stop)	00 - 23 (hour) (Default: 00)
		Minute (stop)	00 - 59 (minute) (Default: 00)

- *1 • Alarm permission: Alarm input (terminal alarm 1, 2 and 3) will be received during the period of the schedule.
- *2 • VMD permission: The video motion detection (VMD) function will be active during the period of the schedule.
- *3 • Access permission: Users whose access level is set to 2 and 3 on the [User auth.] tab of "User mng." page can access the unit only in the period of schedule.
- *4 • Select "On" for "User auth." on the [User auth.] tab of "User mng." page (☞ page 50) and "Off" for "Host auth." on the [Host auth.] tab of "User mng." page (☞ page 50) to validate "Access permission".

About the displayed system log

Refer to page 21 for how to check the system log.

Error indications relating to SMTP

Category	Indication	Description
POP3 server error	Authentication error.	<ul style="list-style-type: none">Entered user name or password may be incorrect. Check if the mail settings are configured correctly.
	Failed to find the POP3 server.	<ul style="list-style-type: none">The IP address of the server may be incorrect. Check if the IP address of the server is configured correctly.The POP3 server may be down. Ask the network administrator.
SMTP server error	Authentication error.	<ul style="list-style-type: none">Entered user name or password may be incorrect. Check if the mail settings are configured correctly.
	Failed to resolve the mail server address from DNS.	<ul style="list-style-type: none">The designated IP address of the DNS may be incorrect. Check if the DNS settings are configured correctly.The DNS server may be down. Ask the network administrator.
	Failed to find the SMTP server.	<ul style="list-style-type: none">The IP address of the server may be incorrect. Check if the IP address of the server is configured correctly.The SMTP server may be down. Ask the network administrator.
Internal error	Undefined error.	<ul style="list-style-type: none">An error occurred in the mail function. Check if the mail settings are configured correctly.

Error indications relating to FTP

Category	Indication	Description
FTP server error	Failed to resolve the FTP server address from DNS.	<ul style="list-style-type: none">The FTP server may be down. Ask the network administrator.
	Failed to find the FTP server.	<ul style="list-style-type: none">The IP address of the server may be incorrect. Check if the IP address of the server is configured correctly.
Connection error	File transfer error.	<ul style="list-style-type: none">The FTP server settings may be incorrect. Check if the FTP settings are configured correctly.
	Passive mode error.	<ul style="list-style-type: none">The settings relating to the indicated item may be incorrect. Check if the FTP settings are configured correctly.
	Log out failed.	
	Failed to change the directory.	
	User name or password isn't correct.	
Internal error	Undefined error.	<ul style="list-style-type: none">An error occurred in the FTP function. Check if the FTP settings are configured correctly.

Error indications relating to DDNS

Category	Indication	Description
Connection error	No response from the DDNS server.	<ul style="list-style-type: none">• The designated IP address of the DDNS may be incorrect. Check if the DDNS settings are configured correctly.• The DDNS server may be down. Ask the network administrator.
	User name or password isn't correct.	<ul style="list-style-type: none">• Entered user name or password may be incorrect. Check if the DDNS settings are configured correctly.
	IP address update failed.	<ul style="list-style-type: none">• IP address update error occurred in the DDNS server. Ask the network administrator.
Internal error	Undefined error.	<ul style="list-style-type: none">• An error occurred in the DDNS function. Check if the DDNS settings are configured correctly.

Error indications relating to NTP

Category	Indication	Description
Connection error	No response from the NTP server.	<ul style="list-style-type: none">• The IP address of the server may be incorrect. Check if the IP address of the server is configured correctly.• The NTP server may be down. Ask the network administrator.
Internal error	Undefined error.	<ul style="list-style-type: none">• An error occurred in the NTP function. Check if the NTP settings are configured correctly.
Synchronizing with NTP succeeded.	NTP update succeeded.	<ul style="list-style-type: none">• Time correction succeeded.

Error indications relating to login

Category	Indication	Description
Login	User name or IP address	<ul style="list-style-type: none">• The login user name will be displayed when "On" is selected for "User auth.".• The IP address of the PC currently accessing to the unit will be displayed when "On" is selected for "Host auth.".

Troubleshooting

Before asking for repairs, check the symptoms with the following table.

Contact your dealer if a problem cannot be solved even after checking and trying the solution in the table or a problem is not described below.

Symptom	Cause/solution	Reference pages
<p>Cannot access from the web browser.</p>	<ul style="list-style-type: none"> Is the LAN cable (category 5 or better) firmly connected to the network connector of the unit? 	<p>Installation Guide</p>
	<ul style="list-style-type: none"> Is the link LED lit? When it is not lit, connection to a LAN may not be established or a network may not be working correctly. Check if the cables have any contact failure or if the wiring is correct or not. 	<p>Installation Guide</p>
	<ul style="list-style-type: none"> Is the power of the unit on? Check if the power of the unit is turned on. 	<p>Installation Guide</p>
	<ul style="list-style-type: none"> Are the set IP addresses valid? 	<p>54</p>
	<ul style="list-style-type: none"> Are you accessing the wrong IP address? Check the connection as follows With the Windows command prompt, > ping "IP address of the unit" If there is reply from the unit, the connection is normal. If not, proceed either of the following. <ul style="list-style-type: none"> Reboot the unit and change the IP address by using the Panasonic IP setup software within 20 minutes after the restart. Reboot the unit while holding the [INITIAL SET] button on the unit. The unit will be initialized and the IP address will return to the default setting "192.168.0.10". After the unit is initialized, access the unit and set the IP address again. (When the unit is initialized, all the settings of the unit previously configured on the setup menu will be initialized.) 	<p>54 Installation Guide</p>

Symptom	Cause/solution	Reference pages
Cannot access from the web browser.	<ul style="list-style-type: none"> Is the same IP address provided to other devices? Are there contradictions between the address and the network subnet to be accessed? <When the unit and the PC are connected in the same subnet> Are the IP addresses of the unit and the PC set in a common subnet? Or is "Use Proxy Server" for the settings of the web browser checked? When accessing the unit in the same subnet, it is recommended to enter the address of the unit in the "Don't Use Proxy For These Addresses" box. <When the unit and the PC are connected in the different subnet> Is the IP address of the default gateway set for the unit correct? 	-
Cannot obtain images on the SD memory card.	<ul style="list-style-type: none"> Is "Allow" selected for "FTP access to unit" on the [Network] tab of "Network" page? It is necessary in advance to select "Allow" for "FTP access to unit" on the [Network] tab of the "Network" page. 	54
	<ul style="list-style-type: none"> Is the entered password correct? Restart the web browser and enter the password again. 	50
	<ul style="list-style-type: none"> Access to the SD memory card may be failed. Restart the browser and retry to obtain images. 	-
No image is displayed.	<ul style="list-style-type: none"> Is the viewer software installed on the PC? Install the viewer software on a PC. 	4
	<ul style="list-style-type: none"> Is the version of DirectX 9.0c or later? Check the version of DirectX as follows. (1) Select "Run..." from the start menu of Windows. (2) Enter "dxdiag" in the displayed dialog box and click the [OK] button. If the version of DirectX is older than 9.0c, upgrade it. 	-

Symptom	Cause/solution	Reference pages
<p>No image is displayed on the "Live" page.</p>	<ul style="list-style-type: none"> When "Every time I visit the webpage" is not selected for "Check for newer versions of stored pages:" in the "Temporary Internet Files" section, images sometimes may not be displayed on the "Live" page. In this case, do the following. <ol style="list-style-type: none"> Select "Internet Options..." from "Tools" on the menu bar of Internet Explorer. The "Internet Options" window will be displayed. When using Internet Explorer 8.0 or Internet Explorer 7.0 Click the [Settings] button in the "Browsing history" section on the [General] tab, and then select "Every time I visit the webpage" for "Check for newer versions of stored pages:" in the "Temporary Internet Files" section on the "Temporary Internet Files and History Settings" window. When using Internet Explorer 6.0 Click the [Settings...] button in the "Temporary Internet files" section on the [General] tab, and then select "Every visit to the page" for "Check for newer versions of stored pages:" on the "Settings" window. 	<p>—</p>
<p>The image is not being refreshed.</p>	<ul style="list-style-type: none"> Depending on the version of your browser, there might be difficulties refreshing the picture, etc. 	<p>Installation Guide</p>
<p>No image is displayed (or too dark).</p>	<ul style="list-style-type: none"> Is the brightness setting set at an appropriate level? Click the [Normal] button of [Brightness]. 	<p>9</p>
<p>Images are displayed washed out.</p>	<ul style="list-style-type: none"> Is the brightness setting set at an appropriate level? Click the [Normal] button of [Brightness]. 	<p>9</p>
<p>Changed settings are not saved.</p>	<ul style="list-style-type: none"> Was the power of the unit turned off soon after the settings had been changed? Wait for around 10 seconds or more when turning off the power of the unit after the setting change. 	<p>—</p>

Symptom	Cause/solution	Reference pages
<p>Images cannot be saved on the SD memory card.</p>	<ul style="list-style-type: none"> • Is the SD memory card inserted correctly? Check if the SD memory card is inserted correctly. 	<p>Installation Guide</p>
	<ul style="list-style-type: none"> • Is the SD memory card formatted? Format the SD memory card. 	<p>31</p>
	<ul style="list-style-type: none"> • Isn't the write protect switch set to "LOCK"? When the write protect switch is set to "LOCK", available size/total size indication of the SD memory card to be displayed on the [SD memory card] tab will be "*****KB/*****KB". 	<p>31</p>
	<ul style="list-style-type: none"> • Isn't the SD memory card out of order? There are limited times to overwrite on an SD memory card. When frequently overwritten, it may be at the end of product life. It is recommended to replace the SD memory card. 	<p>–</p>
<p>Cannot transmit audio to the unit.</p>	<ul style="list-style-type: none"> • Are the microphone and the speaker connected correctly and firmly? Confirm that they are connected correctly and firmly. 	<p>Installation Guide</p>
	<ul style="list-style-type: none"> • Is the viewer software installed on the PC? Confirm that the viewer software "Network Camera View 4" is installed. 	<p>4</p>
<p>The alarm occurrence indication button, the [AUX] buttons and the SD recording status indicator on the "Live" page do not display the current status in real time.</p>	<ul style="list-style-type: none"> • Is the viewer software installed on the PC? Confirm that the viewer software "Network Camera View 4" is installed. 	<p>4</p>
	<ul style="list-style-type: none"> • Is "Real time" selected for "Alarm status update mode"? 	<p>30</p>
<p>No image is displayed on the "Live" page.</p>	<ul style="list-style-type: none"> • Press the [F5] key on the keyboard of the PC or click the [Live] button. 	<p>7</p>
<p>Cannot download the log list.</p>	<ul style="list-style-type: none"> • Download of files using Internet Explorer may be disabled. Click "Internet Options" on the Tool menu of Internet Explorer, and [Security] tab. Then, click the [Custom Level...] button to open the "Security Setting" window. Under "Download", select "Enable" for "Automatic prompting for file downloads". Click the [OK] button. The "Warning" window will be displayed. Click the [Yes] button. 	<p>–</p>

Symptom	Cause/solution	Reference pages
<p>Images are not displayed or not refreshed smoothly.</p>	<ul style="list-style-type: none"> • Delete temporary internet files as follows. <ol style="list-style-type: none"> (1) Select "Internet Options..." under "Tools" on the menu bar of Internet Explorer. The "Internet Options" window will be displayed. (2) Click the [Delete Files...] button in the "Temporary Internet files" section on the [General] tab. 	-
	<ul style="list-style-type: none"> • The firewall function of the anti-virus software may be filtering the port of the unit. Exclude the port number of the unit from the list of the port numbers to be filtered by the anti-virus software. 	-
<p>SDHC/SD memory card error indicator does not light.</p>	<ul style="list-style-type: none"> • Is "Off" selected for "SD memory card error LED" on the "Basic" page? Select "On" for "SD memory card error LED". 	30
<p>H.264 (or MPEG-4) images are not displayed.</p>	<ul style="list-style-type: none"> • When "Network Camera View 4" is deleted from a PC on which both the viewer software "Network Camera View 3" and "Network Camera View 4" are installed, H.264 (or MPEG-4) images may not be displayed. In this case, delete "Network Camera View 3" from the PC and then install "Network Camera View 4". 	4

Symptom

When displaying H.264 (or MPEG-4) images on two or more web browser windows, images from two or more cameras are displayed in sequence on a single browser window.

Cause/solution

- This may occur due to the display adapter and driver combination.
When this has occurred, first update the driver of the display adapter to the latest version.
If updating the driver does not solve the problem, adjust the hardware acceleration as follows.
The following are descriptions for when Windows XP is installed on the PC in use.
(1) Right-click on the desktop and select "Properties" from the displayed pop-up menu.
(2) Select "Settings" from "Display Properties", and then click the [Advanced] button.
(3) Click the [Troubleshoot] tab and disable the DirectDraw acceleration by adjusting the level of "Hardware acceleration".

Reference pages

-

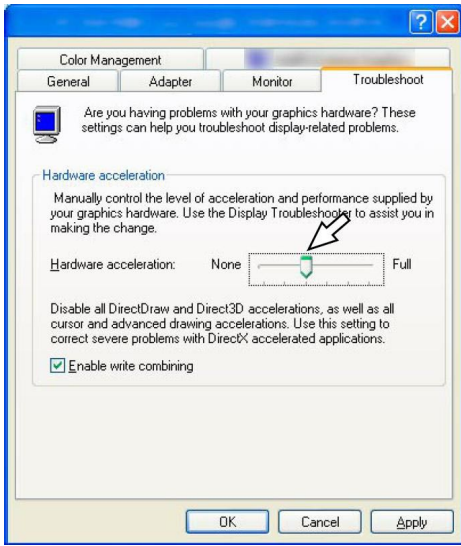

Depending on the OS installed on the PC, the following may occur.

Follow the instructions below when the following has occurred. By performing the following solutions, other applications and the security level may not be affected.

The "Information Bar" expressed in the following symptom and solutions will be displayed just below the address bar only when there is information to communicate.



Symptom	Cause/solution	Reference pages
<p>The following message is displayed on the information bar. "Pop-up blocked. To see this pop-up or additional options, click here..."</p>	<ul style="list-style-type: none"> Click the information bar and select "Always Allow Pop-ups from This Site...". The dialog window saying "Allow pop-ups from this site?" will be displayed. Click the [Yes] button. 	<p>–</p>
<p>The following message is displayed on the information bar. "This site might require the following ActiveX control 'nwc4setup.exe' from 'Panasonic System Networks Co., Ltd.'. Click here to install..." "Pop-up blocked. To see this pop-up or additional options, click here..."</p>	<ul style="list-style-type: none"> Click the information bar and select "Install ActiveX Control". The "Security Warning" window will be displayed. Click the "Install" button on the displayed "Security Warning" window. 	<p>–</p>
<p>An unnecessary status bar or scroll bar is displayed on the pop-up window.</p>	<ul style="list-style-type: none"> Click "Internet Options..." under "Tools" of the menu bar of Internet Explorer, and then click the [Security] tab. Click "Internet" in the "Select a Web content zone to specify its security settings:" section. Then, click the [Custom Level...] button to open the "Security Setting" window. Under "Miscellaneous", select "Enable" for "Allow script-initiated windows without size or position constraints". Click the [OK] button. When the warning window is displayed, click the [Yes] button. 	<p>–</p>

Symptom	Cause/solution	Reference pages
<p>Images are not fit in the frames.</p>	<ul style="list-style-type: none"> When "120 DPI" is not selected for "DPI setting", they may not be displayed correctly. Click the [Settings] tab on the "Properties" window of "Screen" (in the control panel), and then click the [Advanced] button. Change the "DPI setting" to "Large size (120 DPI)". 	<p>-</p>
<p>Displayed images are distorted.</p>	<ul style="list-style-type: none"> Images may be distorted when non-interlace signals, VCR (VTR) signals or signals not compliant with the standard in your locality are transmitted. 	<p>-</p>
<p>Black lines appear on the screen.</p>	<ul style="list-style-type: none"> Black lines may appear on the images displayed on the screen when transmitting the VD2 synchronization signals to cameras not supporting the VD2 synchronization. Deactivate the VD2 synchronization. 	<p>42</p>
<p>Black bars are displayed on both edges of the screen.</p>	<ul style="list-style-type: none"> When the image capture mode is D1, due to the standard of video signal, black bars appear instead of images on both edges of the screen. Black bar(s) also appear(s) even in the VGA mode when signals not compliant with the standard in your locality are transmitted. 	<p>-</p>
<p>A picture is sometimes output twice or skipped.</p>	<ul style="list-style-type: none"> Such a phenomenon occurs when the video frequency of a camera and that of the unit are not fully synchronized. <ul style="list-style-type: none"> When using cameras supporting the VD2 synchronization: <ul style="list-style-type: none"> Select "Int" for "Video sync", and then select "On" for "VD2". When using cameras not supporting the VD2 synchronization: <ul style="list-style-type: none"> Select "Ch1" for "Video sync". <p>With this setting, the unit operates synchronized with the video frequency of the camera that supplies the input signal to Ch1.</p> 	<p>42</p>

Appendix

Possible number of images that can be saved on the SD memory card (as indications)

Important:

- The numbers on the following table are just indications. They are not actual numbers of images that can be saved on the SD memory card. Numbers will differ according to photographic subject to the SD memory card.

Image capture size: VGA

Capacity of SD/ SDHC memory card	Image quality				
	0(Super fine)	1(Fine)	2	3	4
32 GB	160 000 pics	224 000 pics	256 000 pics	288 000 pics	320 000 pics
16 GB	80 000 pics	112 000 pics	128 000 pics	144 000 pics	160 000 pics
8 GB	40 000 pics	56 000 pics	64 000 pics	72 000 pics	80 000 pics
4 GB	20 000 pics	28 000 pics	32 000 pics	36 000 pics	40 000 pics
2 GB	10 000 pics	14 000 pics	16 000 pics	18 000 pics	20 000 pics
1 GB	5 000 pics	7 000 pics	8 000 pics	9 000 pics	10 000 pics
512 MB	2 500 pics	3 500 pics	4 000 pics	4 500 pics	5 000 pics
256 MB	1 250 pics	1 750 pics	2 000 pics	2 250 pics	2 500 pics
Capacity of SD/ SDHC memory card	Image quality				
	5(Normal)	6	7	8	9(Low)
32 GB	352 000 pics	416 000 pics	448 000 pics	480 000 pics	512 000 pics
16 GB	176 000 pics	208 000 pics	224 000 pics	240 000 pics	256 000 pics
8 GB	88 000 pics	104 000 pics	112 000 pics	120 000 pics	128 000 pics
4 GB	44 000 pics	52 000 pics	56 000 pics	60 000 pics	64 000 pics
2 GB	22 000 pics	26 000 pics	28 000 pics	30 000 pics	32 000 pics
1 GB	11 000 pics	13 000 pics	14 000 pics	15 000 pics	16 000 pics
512 MB	5 500 pics	6 500 pics	7 000 pics	7 500 pics	8 000 pics
256 MB	2 750 pics	3 250 pics	3 500 pics	3 750 pics	4 000 pics

Image capture size: QVGA

Capacity of SD/ SDHC memory card	Image quality				
	0(Super fine)	1(Fine)	2	3	4
32 GB	384 000 pics	416 000 pics	432 000 pics	448 000 pics	480 000 pics
16 GB	192 000 pics	208 000 pics	216 000 pics	224 000 pics	240 000 pics
8 GB	96 000 pics	104 000 pics	108 000 pics	112 000 pics	120 000 pics
4 GB	48 000 pics	52 000 pics	54 000 pics	56 000 pics	60 000 pics
2 GB	24 000 pics	26 000 pics	27 000 pics	28 000 pics	30 000 pics
1 GB	12 000 pics	13 000 pics	13 500 pics	14 000 pics	15 000 pics
512 MB	6 000 pics	6 500 pics	6 750 pics	7 000 pics	7 500 pics
256 MB	3 000 pics	3 250 pics	3 375 pics	3 500 pics	3 750 pics
Capacity of SD/ SDHC memory card	Image quality				
	5(Normal)	6	7	8	9(Low)
32 GB	512 000 pics	576 000 pics	608 000 pics	640 000 pics	672 000 pics
16 GB	256 000 pics	288 000 pics	304 000 pics	320 000 pics	336 000 pics
8 GB	128 000 pics	144 000 pics	152 000 pics	160 000 pics	168 000 pics
4 GB	64 000 pics	72 000 pics	76 000 pics	80 000 pics	84 000 pics
2 GB	32 000 pics	36 000 pics	38 000 pics	40 000 pics	42 000 pics
1 GB	16 000 pics	18 000 pics	19 000 pics	20 000 pics	21 000 pics
512 MB	8 000 pics	9 000 pics	9 500 pics	10 000 pics	10 500 pics
256 MB	4 000 pics	4 500 pics	4 750 pics	5 000 pics	5 250 pics

How the logs and images are saved depending on the settings for "Alarm"

[Log] tab	[SD memory card] tab		Logs and associated images
Alarm: Save logs	SD memory card	Save trigger	
On	Use	Alarm input	<p>Logs: Up to 5 000 logs will be kept. When more than 5 000 event logs are filed, the older event logs will be overwritten by the newer event logs.</p> <p>Images: Will be saved. When available capacity of the SD memory card ran out, the older images will be overwritten by the newer images. Even when available capacity of the SD memory card is enough, the older images will be overwritten by the newer images when more than 5 000 logs are filed since associated images are to be deleted when the logs are deleted.</p>
		Other than "Alarm input"	<p>Logs: Up to 5 000 logs will be kept. When more than 5 000 logs are filed, the older logs will be overwritten by the newer logs. In this case, the oldest log is the first to be overwritten.</p> <p>Images: Will not be saved.</p>
	Not use	–	<p>Logs: Up to 1 000 logs will be kept. When more than 1 000 logs are filed, the older logs will be overwritten by the newer logs. In this case, the oldest log is the first to be overwritten. When the power of the unit is turned off, logs will be deleted.</p> <p>Images: Will not be saved.</p>
Off	Use	Alarm input	<p>Logs: Will not be saved.</p> <p>Images: Will be saved. When available capacity of the SD memory card ran out, the older images will be overwritten by the newer images.</p> <p>* To display images on the SD memory card, it is necessary to copy them onto the PC first. (☞ Page 31)</p>
		Other than "Alarm input"	<p>Logs: Will not be saved.</p> <p>Images: Will not be saved.</p>
	Not use	–	<p>Logs: Will not be saved.</p> <p>Images: Will not be saved.</p>

How the logs and images are saved depending on the settings for "Manual"

[Log] tab	[SD memory card] tab			Logs and associated images
Manual: Save logs	SD memory card	Save trigger	Overwrite	
On	Use	Manual	On	<p>Logs: Up to 5 000 logs will be kept. When more than 5 000 logs are filed, the older logs will be overwritten by the newer logs. In this case, the oldest log is the first to be overwritten.</p> <p>Images: Will be saved. When available capacity of the SD memory card ran out, the older images will be overwritten by the newer images. Even when available capacity of the SD memory card is enough, the older images will be overwritten by the newer images when more than 5 000 logs are filed since associated images are to be deleted when the logs are deleted.</p>
			Off	<p>Logs: Up to 5 000 logs will be kept. When more than 5 000 logs are filed, no log will be filed newly anymore. Even when available capacity of the SD memory card ran out and it is not enough to save images, logs will be kept on being filed until it reaches 5 000 logs.</p> <p>Images: Will be saved. When available capacity of the SD memory card ran out, saving of images will become impossible. Even when available capacity of the SD memory card is enough, images associated with logs will be kept on being saved until number of filed logs reaches 5 000.</p>
	Other than "Manual"	–	<p>Logs: Will not be saved.</p> <p>Images: Will not be saved.</p>	
	Not use	–	–	<p>Logs: Will not be saved.</p> <p>Images: Will not be saved.</p>
Off	Use	Manual	On	<p>Logs: Will not be saved.</p> <p>Images: Will be saved. When available capacity of the SD memory card ran out, the older images will be overwritten by the newer images. * To display images on the SD memory card, it is necessary to copy them onto the PC first. (Page 31)</p>
			Off	<p>Logs: Will not be saved.</p> <p>Images: Will be saved. When available capacity of the SD memory card ran out, saving of images will become impossible. * To display images on the SD memory card, it is necessary to copy them onto the PC first. (Page 31)</p>
	Other than "Manual"	–	<p>Logs: Will not be saved.</p> <p>Images: Will not be saved.</p>	
	Not use	–	–	<p>Logs: Will not be saved.</p> <p>Images: Will not be saved.</p>

How the logs and images are saved depending on the settings for "FTP error"

[Log] tab	[SD memory card] tab		Logs and associated images
FTP error: Save logs	SD memory card	Save trigger	
On	Use	FTP error	<p>Logs: Up to 5 000 logs will be kept. When more than 5 000 logs are filed, no log will be filed newly anymore. Even when available capacity of the SD memory card ran out and it is not enough to save images, logs will be kept on being filed until it reaches 5 000 logs.</p> <p>Images: Will be saved. When available capacity of the SD memory card ran out, saving of images will become impossible. Even when available capacity of the SD memory card is enough, images associated with logs will be kept on being saved until number of filed logs reaches 5 000.</p>
		Other than "FTP error"	<p>Logs: Will not be saved.</p> <p>Images: Will not be saved.</p>
	Not use	–	<p>Logs: Will not be saved.</p> <p>Images: Will not be saved.</p>
Off	Use	FTP error	<p>Logs: Will not be saved.</p> <p>Images: Will be saved. When available capacity of the SD memory card ran out, saving of images will become impossible. * To display images on the SD memory card, it is necessary to copy them onto the PC first. (Page 31)</p>
		Other than "FTP error"	<p>Logs: Will not be saved.</p> <p>Images: Will not be saved.</p>
	Not use	–	<p>Logs: Will not be saved.</p> <p>Images: Will not be saved.</p>

Directory structure of drive B

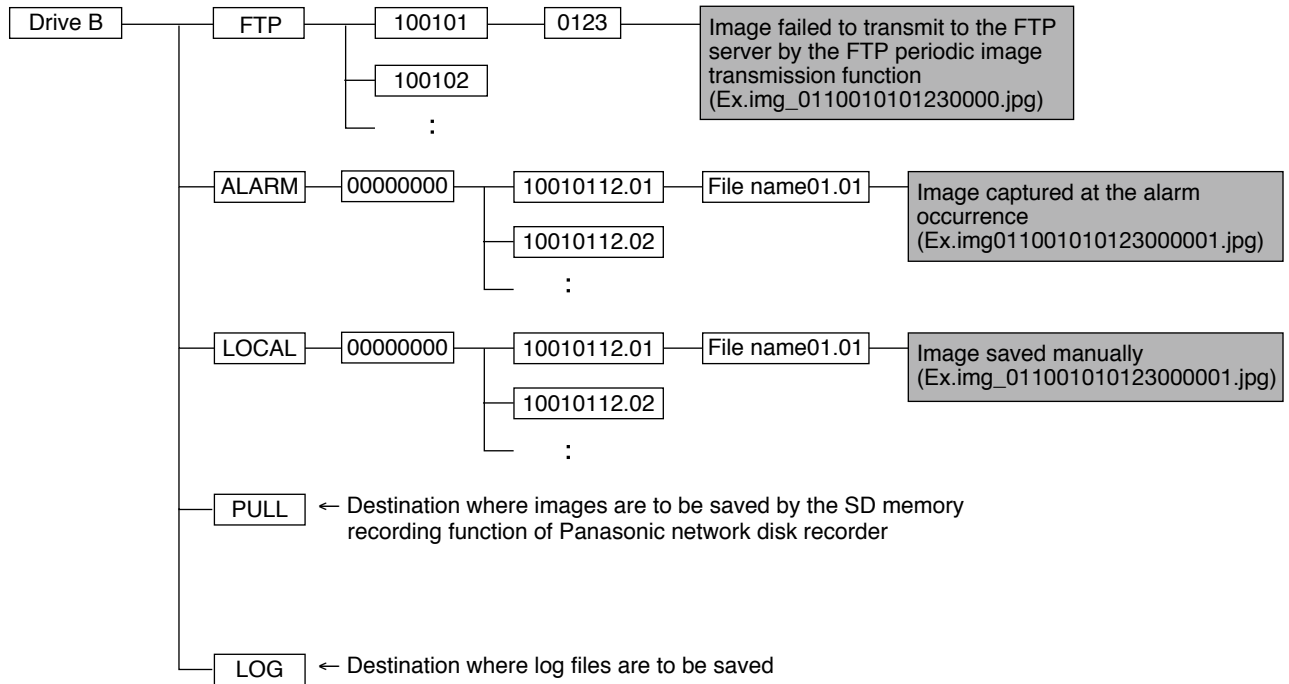

For U.S. and Canadian fields:

**Panasonic System Networks Company of America,
Unit of Panasonic Corporation of North America**

www.panasonic.com/business/
For customer support, call 1.800.528.6747
Three Panasonic Way, Secaucus, New Jersey 07094 U.S.A.

Panasonic Canada Inc.

5770 Ambler Drive, Mississauga, Ontario, L4W 2T3 Canada
(905)624-5010
www.panasonic.ca

For European and other fields:

Panasonic Corporation

<http://panasonic.net>

Importer's name and address to follow EU rules:

Panasonic Testing Centre
Panasonic Marketing Europe GmbH
Winsbergring 15, 22525 Hamburg F.R.Germany